



ADAMS

ENGINEERS AND EQUIPMENT, INC.

HP JetFusion 3D Printing Handbook



Pages 3-10: Technology Introduction

Page 11: How Does HP MJF Work? - Material Selection

Pages 12-13: Polyamide Family - Material Selection

Pages 14-17: Design for HP MJF - Design Guidelines

Pages 18-19: Design for Accuracy

Page 20: Design for Aesthetics

Pages 21-22: Design for Cleaning

Pages 23-26: Dimensional tolerancing, Design for HP MJF: Union joints design Union Joints Design

Pages 27-30: Types of Fits - Union Joints Design

Pages 31-34: Threaded Unions

Pages 35-38: Inserts

Pages 39-46: Adhesive Bondings

Pages 47-58: Snap-Fits

Pages 59-62: Recommended Formats and Resolutions

Pages 63-74: General Recommendations for Printing Processes - Tuning your HP MJF to the Design

Pages 75-82: Process for Aesthetic

Pages 83-86: Machining Recommendations

Pages 87-98: Design for Interlocking Parts

Pages 99-102: Hinge Design

Pages 103-104: Design for Sound



Transforming Design and Manufacturing

Technology introduction

3D Printing transformation

Until the introduction of the Industrial Revolution, hand-crafted one-off design and manufacturing was the norm. Blacksmiths were both designer and manufacturer; each pair of horseshoes they crafted was unique, even when made for the same horse! Production was slow and products were made to order. Save for a few high value items like coffee, tea, and spices, products were rarely, if ever, made in advance, inventoried, and ready for sale. Supply chains for manufactured goods were nonexistent.

But this changed in the 18th century with the rise of the machine and the first Industrial Revolution. Textiles went from handspun wool to cotton woven with a spinning wheel and loom, leading to faster production time with lower material costs. The introductions of the weaving loom, cotton gin, steam engine, and factories for assembling products changed the very nature of how things were made.

Over a period of roughly 75 years—late 1700s to the mid-1800s—production became increasingly standardized, and each task from design to manufacturing and assembly was broken down into discrete functions. Henry Ford's Model T took things to a new level at the start of the 20th century, gaining speed and efficiency with the introduction of mass production and factories. New materials and methodologies from metal casting to Injection Molding have helped to produce most of the products in the world today. With refined workforce and manufacturing practices and the computer automation of previously manual labor-intensive tasks throughout the last century, production rates have accelerated, resulting in the ability to produce in larger quantities. Those who failed to adopt were left behind.

Despite all of this forward movement, the basic design and manufacturing process hasn't fundamentally changed over the past 100+ years. In fact, not only have the processes not improved but they've also put a substantial strain on our natural resources, pushed production farther and farther from the consumer, and constrained design flexibility and customization.

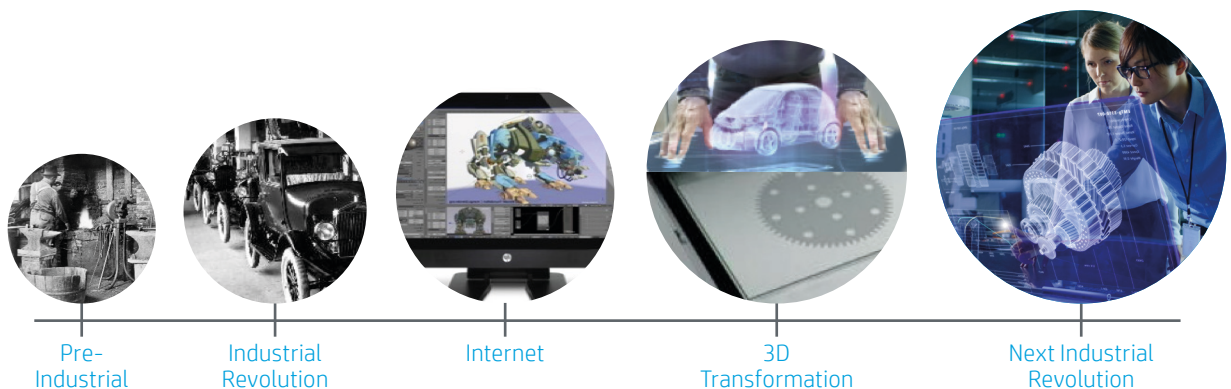

Figure 1: Driving the next Industrial Revolution through the democratization of design and ubiquitous production

Why consider 3D printing as a final part fabrication process?

During the next 10 to 15 years, socioeconomic forces, advanced design and production innovation, and highly automated printing processes will intersect to create a massive transformation of manufacturing as we know it today.

There has been a lot of talk about innovative part designs, designs that could not be fabricated by any of the historical analog processes. This begins now. Unique geometric designs can be made and printed even today. Improvements in function and aesthetics can be realized and in a much shorter development time than was ever possible. Eventually, design tools and printers will evolve to enable voxel-by-voxel differentiation, providing even more product competitiveness.



Figure 2: Real-time medical and prosthesis design. Orthotic helmet image courtesy of Invent Medical.

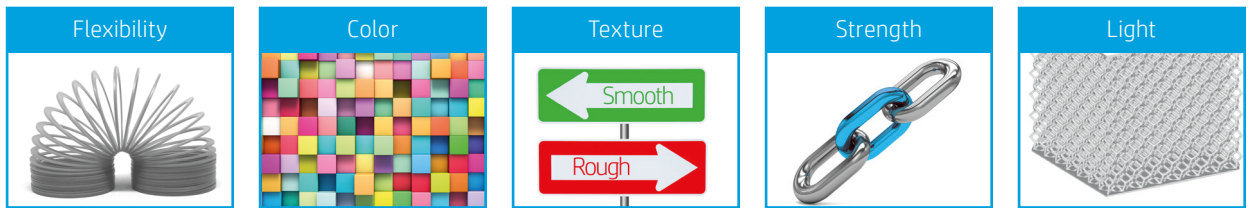

Figure 3: Designers can create customized, flexible, strong, and light 3D printed products.

Further, even if designs were not going to become more complex, there are some fundamental advantages to adopting processes that enable faster and less-expensive product development cycles. To illustrate, a typical return on investment graphic is shown in Figure 1.

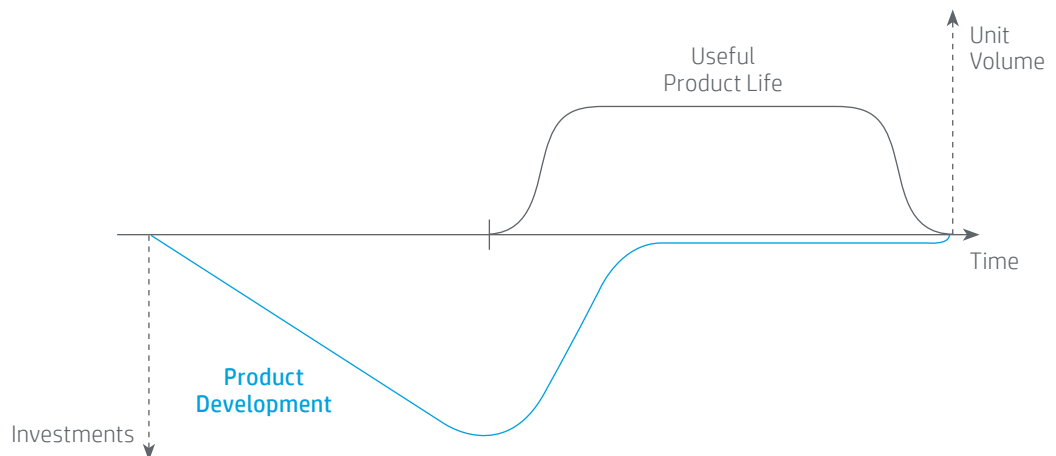

Figure 4: Illustration of return on investment for new hardware product development

The challenge with new hardware product development delays, until now, is two-fold. If you delay for a month, for example, not only do you continue to invest at peak levels for an additional month, but you also reduce the useful competitive life of the product by a month, missing a whole month of stable revenues. If you were to recalculate the return on investment from beginning to end, you might find that the investment no longer makes sense. This is illustrated in Figure 2.

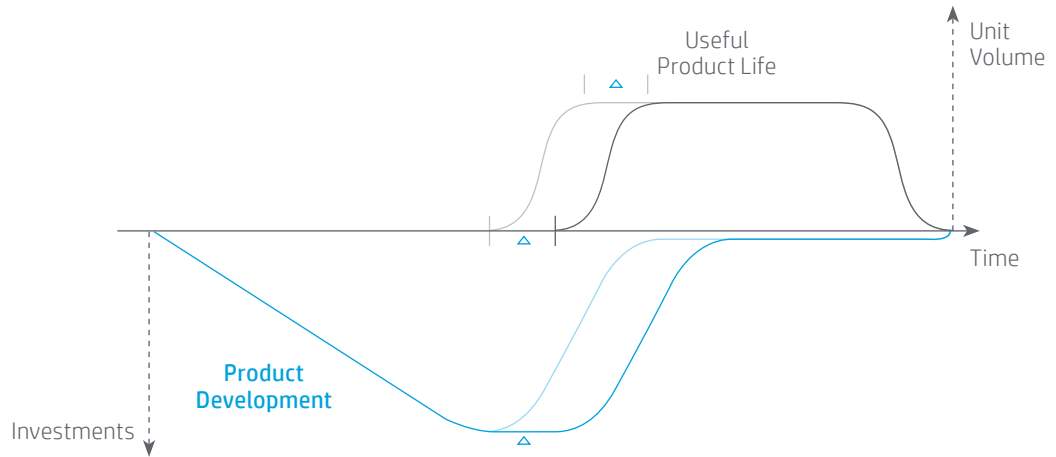

Figure 5: Illustration of a recalculated return on investment for new hardware product development

It is normal to consider the money spent as sunk costs and convince yourself that it still makes sense to move forward. But what if you did not need to delay? What if you had a process that would prevent you from tooling unstable part designs and allow you to begin manufacturing on time? If you had a 3D printer with equal quality and reasonable capacity, this would be possible. You may eventually tool these parts, but you use 3D printing to hold schedule. Applying this strategy—known as bridge manufacturing—it is possible to iterate more frequently on these unstable designs, and the product quality could actually improve.

If you had a 3D printer that had equal quality, the necessary long-term capacity, and a competitive cost, even at high volumes, you may not ever have to invest in tools for certain parts.

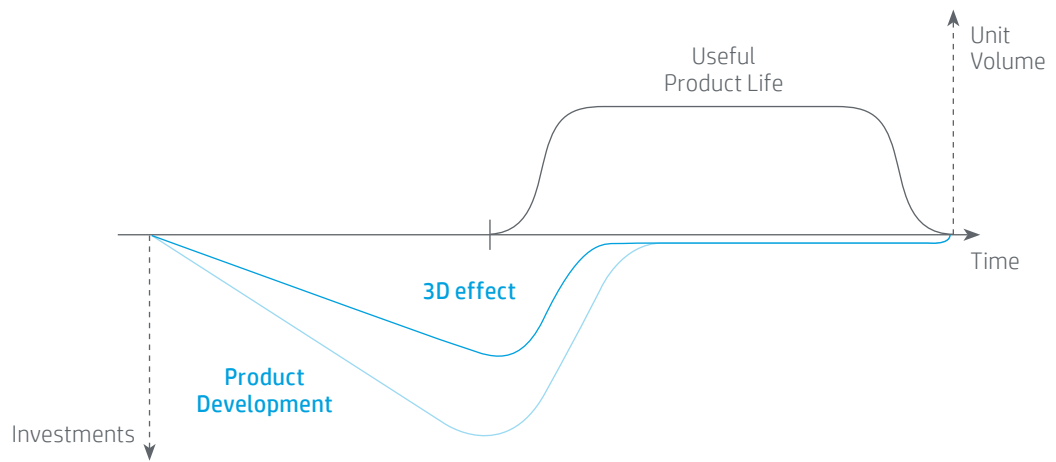

Figure 6: Illustration of the 3D printing effect on investment in new hardware product development

While complex products require parts from several different processes, eventually all parts could be 3D printed, and you could not only develop new hardware products for less investment, you could also introduce them sooner or, effectively, with higher frequency, allowing you to keep your competitive edge.

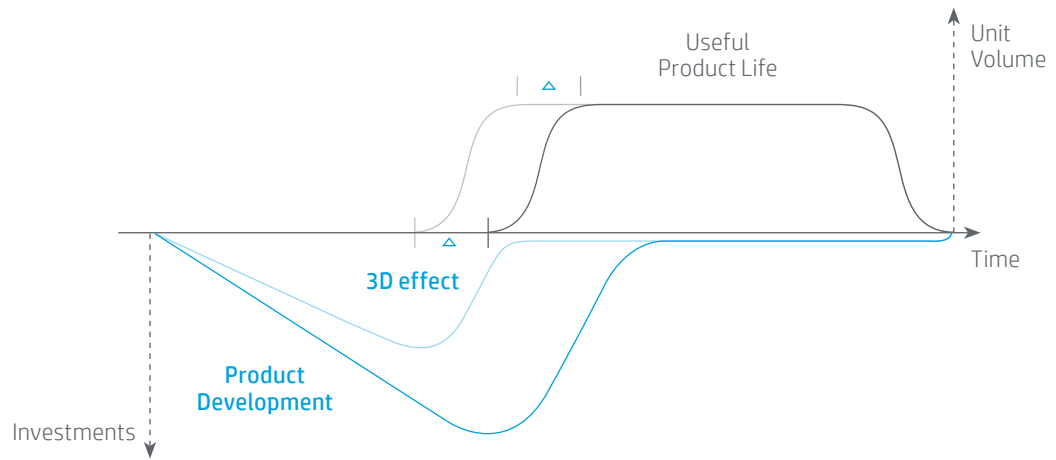

Figure 7: Illustration of the 3D printing effect on product life in new hardware product development

With the introduction of the HP Jet Fusion 3D Printing Solutions, based on a disruptive HP Multi Jet Fusion technology, new levels of 3D printing production speed can be achieved, at reduced operating cost, for parts which offer an unprecedented combination of both fine detail and end part strength. The product development cycle can now be disrupted.

Cost and quality: Former barriers to adoption

In choosing which process to use for final part manufacturing of a specific part, it's important to consider which may be the least expensive combination of process and material that meets the design requirements. Until now, the two main barriers to adopting 3D printing—cost and quality—were factors in making this decision.

The first barrier to adoption has been the effective cost per part and the ability for 3D printing processes to compete head on against Injection Molding. For years, the cost per part for the 3D printing digital processes has been considered a flat line, and the first part can cost the same as the 1,000th part, which would cost the same as the 10,000th part (shown in figure 5). This simplified view leads to a few negative assumptions.

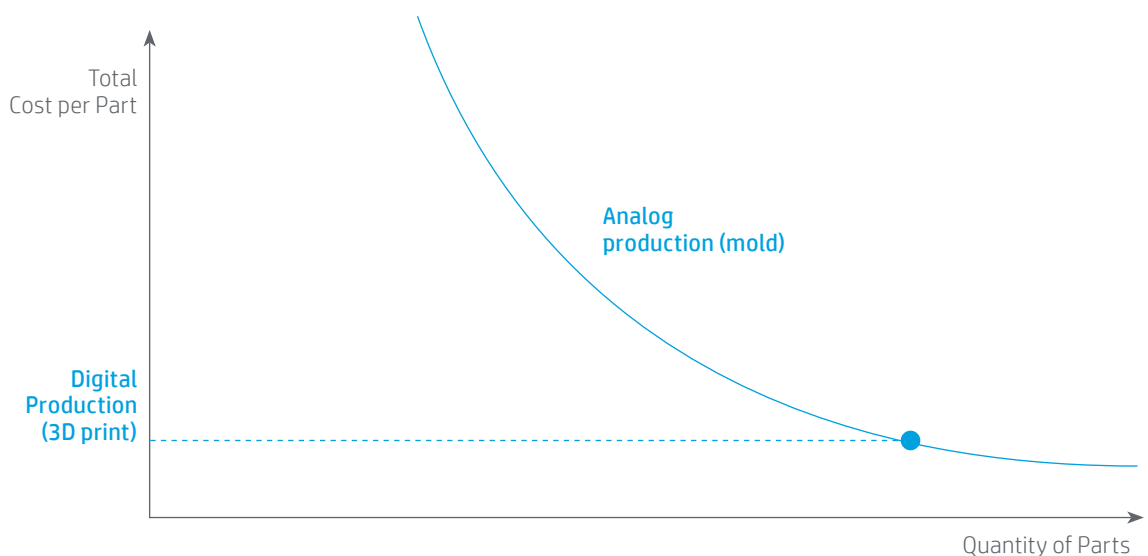

Figure 8: Breakeven curve assuming a productive 3D printer and no set-up costs or development time

Until the introduction of HP Multi Jet Fusion technology, the first negative assumption of 3D printing has been that the printers have reasonable capacity to meet a company’s manufacturing forecasts. The fact is, however, that paying hundreds of thousands of dollars for a system that can only fabricate a couple of hundred parts per year results in a flat line that is really a step function (as shown in figure 6). With the high productivity of HP Multi Jet Fusion technology, the step can be tens of thousands of parts instead of hundreds (depending on the part size).

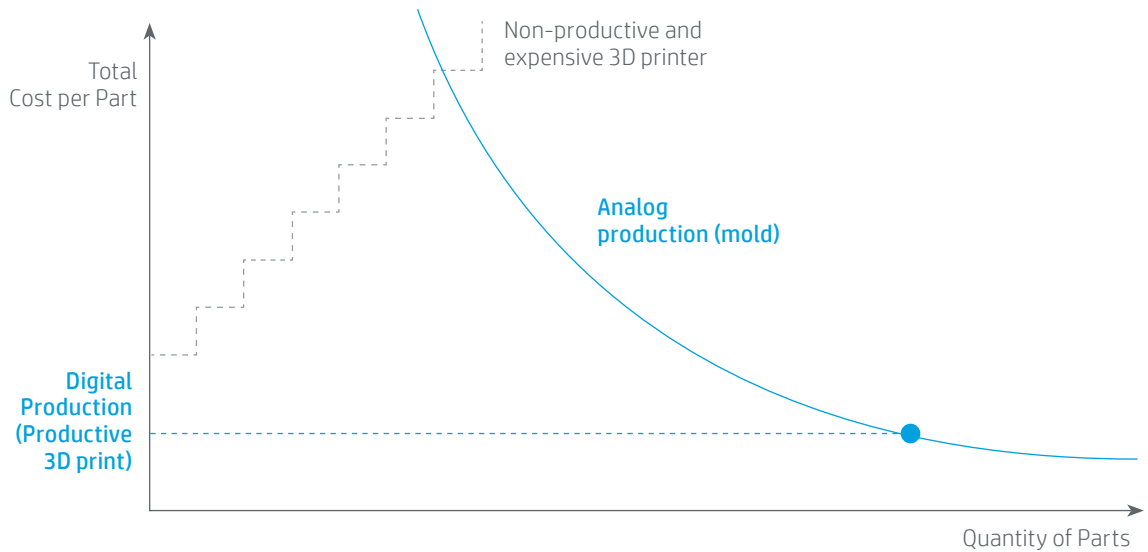

Figure 9: Breakeven curve for a non-productive 3D printer and no set-up costs or development time

The second negative assumption of 3D printing in that flat-line curve is that you can go from design to manufacturing without any development or set-up costs. The truth is that any process will need some sort of development phase in order to meet the quality requirements of the design. During this development phase, both the design and process will always require some tuning. The designer tunes the design to the final fabrication process, and the process engineer tunes the process to the design and its requirements. The beauty of this tuning in 3D printing, or digital fabrication, is that the tuning can be done digitally, and no expensive tooling, with expensive reworks, needs to be included.

There are several layers to optimizing and tuning a design to HP Multi Jet Fusion.

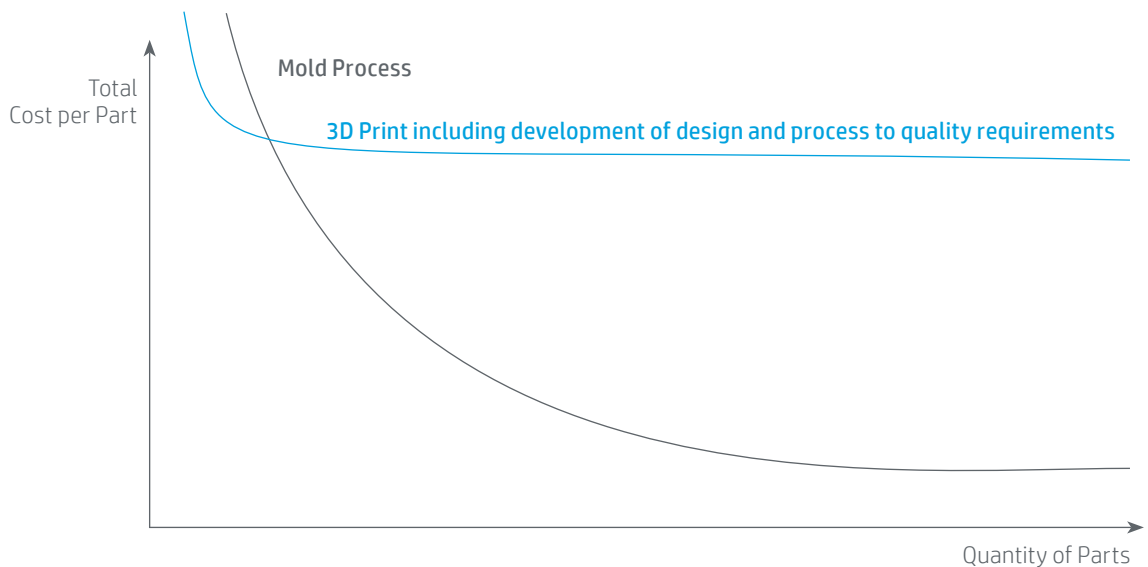

Figure 10: Breakeven curve for 3D printing including development of design and process to quality requirements

The first layer involves following the fundamental guidelines for the fabrication process. All processes have fundamental design guidelines as driven by the physics of the process itself. HP Multi Jet Fusion has such guidelines, like recommended wall thickness. If you choose to follow the guidelines, you will have improved quality and yield, and your effective cost per part will decrease.

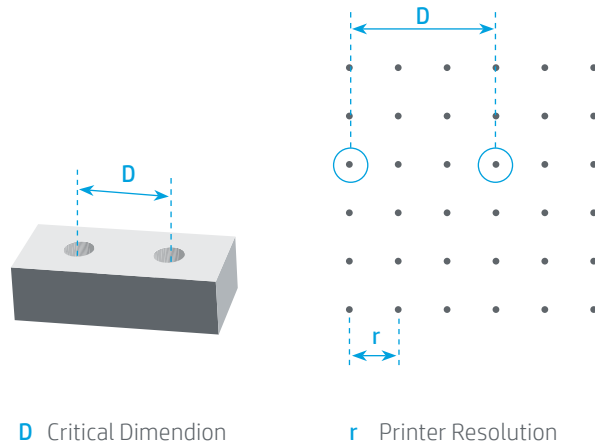

Figure 11: Example guideline: To attain maximum accuracy, critical dimensions should be an integral number of the printer resolution

The next level in optimization involves making slight changes to the design that allow for more efficient use of material or more efficient space management of the build volume. If less material can be used for the part and/or more parts can fit into the same build volume, the effective cost per part will decrease even further.



Figure 12: Optimized material use

Figure 13: Optimized use of the build volume

The final design optimization for 3D printing is maintaining the third dimension and combining parts. When a mechanical designer takes a system function and breaks this into parts that can be easily Injection Molded, the resulting parts are largely 2.5-dimensional, meaning that they tend to have two larger dimensions and one smaller dimension. This is because molds must open and close easily. If you intend to 3D print the parts, the parts can remain integrated, and then the breakeven curve becomes a comparison of one part versus several parts from several molds.

Injection Molded Version

HP Multi Jet Fusion

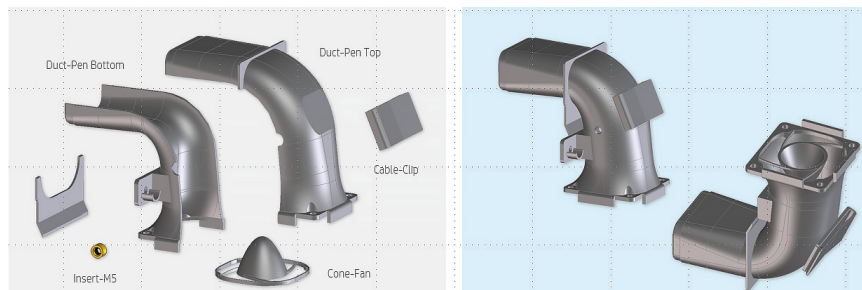

Figure 14: Maintain the integration of the functional design intent

What is the proposed solution?

In the mid-term, HP Jet Fusion 3D Solution will complete the portfolio to best accompany our customers in the journey of adopting 3D printing technologies, from assessment on where to start, how to design to how to maximize of your HP Jet Fusion 3D Printing Solution.

Software can be developed to help designers tune their designs to HP Multi Jet Fusion or allow process engineers to tune the HP Multi Jet Fusion process to the design. But domain knowledge must come first.

This HP Multi Jet Fusion handbook is a vehicle for capturing the domain knowledge around HP Multi Jet Fusion and sharing it with the world so that it can be applied immediately.

This handbook includes a design chapter to help designers understand the unique design guidelines for HP Multi Jet Fusion that should be followed to obtain optimal quality. Further, the design chapter will eventually provide additional guidelines on how to optimize designs for cost when fabricating with HP Multi Jet Fusion.

In future revisions, this handbook will also include chapters on process optimization to help process engineers select the right parameters for quality and cost, such as orientation or spacing of parts in a build.

Additional future chapters will include HP Multi Jet Fusion material selection, quality control, and other helpful knowledge for facilitating the adoption of HP Multi Jet Fusion into your library of possible processes for fabricating final parts.

Approaching the perfect storm

When cost and quality can be achieved, the true potential of 3D printing can be realized. Future design tools will enable designers to develop more and more differential products through unique designs that cannot be fabricated by analog processes. The seamlessness of the interface between design tools and 3D printers will become even more important as future printers enable multiple properties within one object, enabling changing colors, textures, transparency, strength, elasticity, and more.

What we design, as well as how and where we design, sell, and manufacture products will continue to become both hyper-global and hyper-competitive. To stay successful through this transformation, companies will need to either adopt or be left behind.

Along this journey, this handbook will help guide the transformation, with updates posted online at hp.com/go/MJFHandbook. In the meantime, welcome to the future of part fabrication.

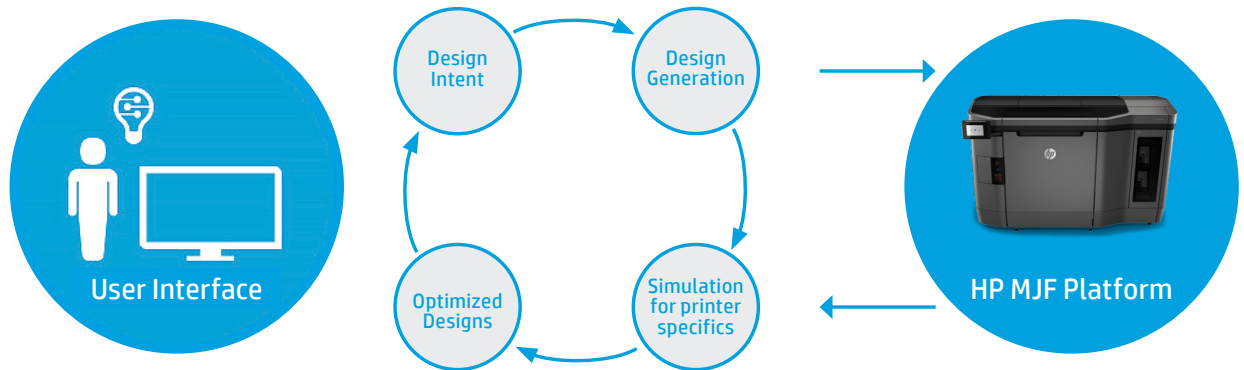

Figure 15: Designers can create customized predictable 3D printed products when printer capability is communicated upstream

©Copyright 2019 HP Development Company, L.P. The information contained herein is subject to change without notice.

The information contained herein is provided for information purposes only. The only terms and conditions governing the sale of HP 3D printer solutions are those set forth in a written sales agreement. The only warranties for HP products and services are set forth in the express warranty statements accompanying such products and services. Nothing herein should be construed as constituting an additional warranty or additional binding terms and conditions. HP shall not be liable for technical or editorial errors or omissions contained herein and the information herein is subject to change without notice.



How does HP Multi Jet Fusion work?

Material selection



Introduction

HP Multi Jet Fusion (MJF) technology is a powder-bed fusion 3D printing technology that allows for the production of accurate, functional prototypes and final parts, including color parts. In addition, HP MJF is a technology that does not require support structures, thus enabling the design of complex geometries without additional costs, which would be expensive or not even possible to produce with traditional manufacturing processes.

HP MJF 3D printing process

The HP MJF 3D printing process begins with a thin layer of uniformly pre-heated polymer powder particles that is spread across the build platform.

Then, to achieve part quality at a high speed and produce truly functional parts, HP MJF technology uses the HP multi-agent printing process. HP's in-depth knowledge of 2D printing solutions and the capability of HP's proprietary architecture makes it possible to print millions of drops per second along each inch of the bed width, thus enabling extreme precision and dimensional accuracy.

HP Multi Jet Fusion's multi-agent printing process can control the exact amount of each agent that is deposited in each voxel of the intended part. This printing process involves two different types of agents that are applied across the build platform: fusing agents and detailing agents.

A fusing agent is applied where the particles are meant to fuse together in the powder in order to create the corresponding part cross section, leaving the rest of the powder unaltered. A detailing agent is applied to the edges of the part in order to modify the fusing process and create fine detail and smooth surfaces.

Next, an energy source passes over the build platform, provoking a reaction between the agents and the material that causes the material to selectively fuse to form a complete layer, thus resulting in production throughput, material density similar to common Injection Molded plastics, and consistent mechanical properties in all directions.

The process is then repeated until a completely functional part has been formed.

The 3D printing process using HP MJF is summarized in the following figure:

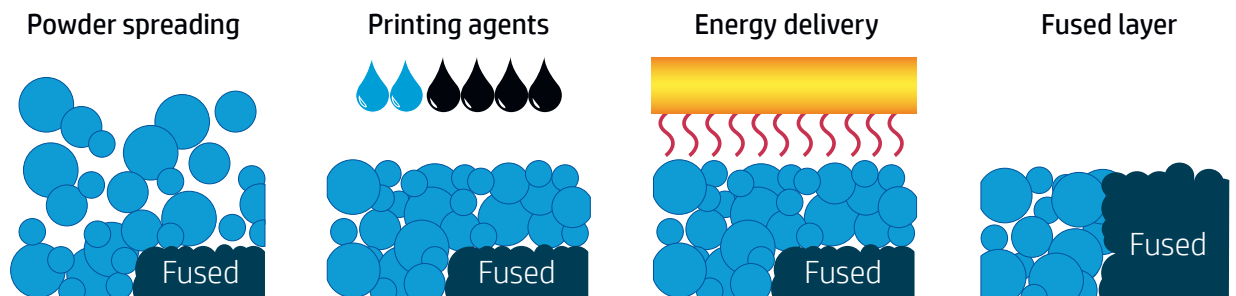

Figure 1: 3D printing process with HP Multi Jet Fusion

©Copyright 2019 HP Development Company, L.P. The information contained herein is subject to change without notice.

The information contained herein is provided for information purposes only. The only terms and conditions governing the sale of HP 3D printer solutions are those set forth in a written sales agreement. The only warranties for HP products and services are set forth in the express warranty statements accompanying such products and services. Nothing herein should be construed as constituting an additional warranty or additional binding terms and conditions. HP shall not be liable for technical or editorial errors or omissions contained herein and the information herein is subject to change without notice.





Polyamide family

Material selection

Introduction

HP is working hard to enable new materials innovations that break down some of the traditional barriers to 3D printing adoption—cost, quality performance, and diversity.

Therefore, a selected range of polyamide-based materials has been engineered for HP Multi Jet Fusion technology, thus offering engineering-grade thermoplastics that provide optimal output quality and high reusability at a low cost per part.¹

HP 3D Printing polyamide-based materials for HP Jet Fusion 4200 3D Printing Solution and HP Jet Fusion 5200 Series 3D Printing Solutions

HP 3D Printing polyamide-based materials for HP Jet Fusion 3D 4200 3D Printing Solution and HP Jet Fusion 5200 Series 3D Printing Solutions include HP 3D High Reusability PA 12 (HP 3D HR PA 12), HP 3D High Reusability PA 12 Glass Beads (HP HR PA 12 GB), and HP 3D High Reusability PA 11 (HP HR PA 11).

HP 3D HR PA 12: Ideal for producing strong, functional, detailed complex parts

- Robust thermoplastic that produces high-density parts with balanced property profiles and strong structures.
- Provides excellent chemical resistance to oils, greases, aliphatic hydrocarbons, and alkalis.²
- Meets biocompatibility certifications such as USP Class I-VI and US FDA guidance for Intact Skin Surface Devices.³
- Provides the best balance between performance and cost compared with other HP 3D Printing polyamide-based materials.
- Engineered to produce final parts and functional prototypes with fine detail and dimensional accuracy, and designed for the production of functional parts across a variety of industries.
- Ideal for complex assemblies, housings, enclosures, and watertight applications, achieving watertight properties without any additional post-processing.
- Compatible with the HP Jet Fusion 4200 3D Printing Solution and the HP Jet Fusion 5200 Series 3D Printing Solutions.

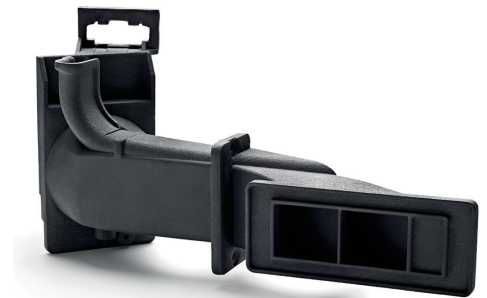

Figure 1: HP 3D HR PA 12 part after graphite blasting post-processing

HP 3D HR PA 12 Glass Beads: Ideal for producing stiff, functional parts

- 40% glass bead filled thermoplastic material with both optimal mechanical properties and high reusability.⁴
- Provides dimensional stability as well as repeatability.⁵
- Engineered to produce common glass bead applications with detail and dimensional accuracy, and designed for production of functional parts across a variety of industries.
- Ideal for applications requiring high stiffness like enclosures, housings, fixtures, and tooling.
- Compatible with the HP Jet Fusion 4200 3D Printing Solution.

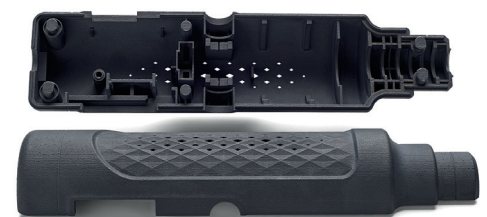

Figure 2: HP 3D HR PA 12 GB part courtesy of NACAR

HP 3D HR PA 11: Ideal for producing strong, ductile,⁶ functional parts

- Thermoplastic material with renewable raw material from vegetable castor oil (reduced environmental impact).⁶ It delivers optimal mechanical properties, providing an excellent chemical resistance² and enhanced elongation-at-break.⁵
- Easy-to-process material that enables high productivity and less waste.⁷
- Engineered to reliably produce final parts and functional prototypes with fine detail and dimensional accuracy, and designed for the production of functional and final parts across a variety of industries.
- Provides impact resistance and ductility⁵ for prostheses, insoles, sporting goods, snap-fits, living hinges, and more.
- Compatible with the HP Jet Fusion 4200 3D Printing Solution and the HP Jet Fusion 5200 Series 3D Printing Solutions.



Figure 3: HP 3D HR PA 11 part
courtesy of NACAR

HP 3D Printing polyamide-based materials for HP Jet Fusion 500 Series 3D Printers

HP 3D Printing polyamide-based materials for HP Jet Fusion 500 Series 3D Printers include HP 3D HR CB PA 12.

HP 3D HR CB PA 12: engineering-grade, full-color,⁸ and white parts

- A robust thermoplastic that produces high-density parts with balanced property profiles and strong structures.
- Provides excellent chemical resistance to oils, greases, aliphatic hydrocarbons, and alkalis.²
- Designed for the production of full-color⁸ and white functional parts across a variety of industries.
- Ideal for color⁸ and white parts like jigs, fixtures, labeling, presentation models, and functional prototypes.

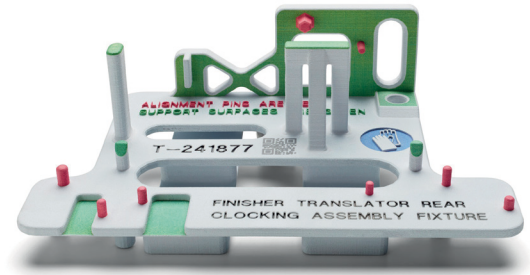

Figure 4: HP 3D HR CB PA 12 part

For more information please visit:
hp.com/go/3Dmaterials

1. Based on internal testing and public data for solutions on market as of April, 2016. Cost analysis based on: standard solution configuration price, supplies price, and maintenance costs recommended by manufacturer. Cost criteria: printing 1.4 full build chambers of parts per day/5 days per week over 1 year of 30 cm³ parts at 10% packing density on fast print mode using HP 3D High Reusability PA 12 material, and the powder reusability ratio recommended by manufacturer, and printing under certain build conditions and part geometries.

2. Tested with diluted alkalis, concentrated alkalis, chlorine salts, alcohol, ester, ethers, ketones, aliphatic hydrocarbons, unleaded petrol, motor oil, aromatic hydrocarbons, toluene, and DOT 3 brake fluid.

3. Based on HP internal testing, June 2017, HP 3D600/3D700/3D710 Fusing and Detailing Agents and HP 3D High Reusability PA 12 and HP 3D High Reusability PA 11 powders meet USP Class I-VI and US FDA's guidance for Intact Skin Surface Devices. Tested according to USP Class I-VI including irritation, acute systemic toxicity, and implantation; cytotoxicity per ISO 10993-5, Biological evaluation of medical devices—part 5: Tests for in vitro cytotoxicity, and sensitization per ISO 10993-10, Biological evaluation of medical devices—Part 10: Tests for irritation and skin sensitization. It is the responsibility of the customer to determine that its use of the fusing and detailing agents and powder is safe and technically suitable to the intended applications and consistent with the relevant regulatory requirements (including FDA requirements) applicable to the customer's final product. For more information, see hp.com/go/3Dmaterials.

4. Based on using recommended packing densities, offers high reusability of surplus powder. Liters refers to the materials container size and not the actual materials volume. Materials are measured in kilograms.

5. Testing according to ASTM D638, ASTM D256, and ASTM D648 using HDT at different loads with a 3D scanner. Testing monitored using statistical process controls.

6. HP 3D High Reusability PA 11 powder is made with 100% renewable carbon content derived from castor plants grown without GMOs in arid areas that do not compete with food crops. HP 3D High Reusability PA 11 is made using renewable sources and may be made together with certain non-renewable sources. A renewable resource is a natural organic resource that can be renewed at the same speed in which it is consumed. Renewable stands for the number of carbon atoms in the chain coming from renewable sources (in this case, castor seeds) according to ASTM D6866.

7. Easier to process than standard HP 3D High Reusability PA 12, providing proper fusing along with good spreadability and compatibility due to its small particle size.

8. Full color parts applicable only with the HP Jet Fusion 580 Color 3D Printer. General availability second half 2019.

©Copyright 2019 HP Development Company, L.P. The information contained herein is subject to change without notice.

The information contained herein is provided for information purposes only. The only terms and conditions governing the sale of HP 3D printer solutions are those set forth in a written sales agreement. The only warranties for HP products and services are set forth in the express warranty statements accompanying such products and services. Nothing herein should be construed as constituting an additional warranty or additional binding terms and conditions. HP shall not be liable for technical or editorial errors or omissions contained herein and the information herein is subject to change without notice.





Best practices

Design for HP MJF: Design guidelines

Introduction

As with other 3D printing technologies, there is a set of recommendations to follow when designing for HP Multi Jet Fusion technology to ensure parts and features are printed to specification.

Wall thickness

In general, the minimum recommended wall thickness is 0.3 mm for short walls oriented in the XY plane, and 0.5 mm for short walls oriented in the Z direction.

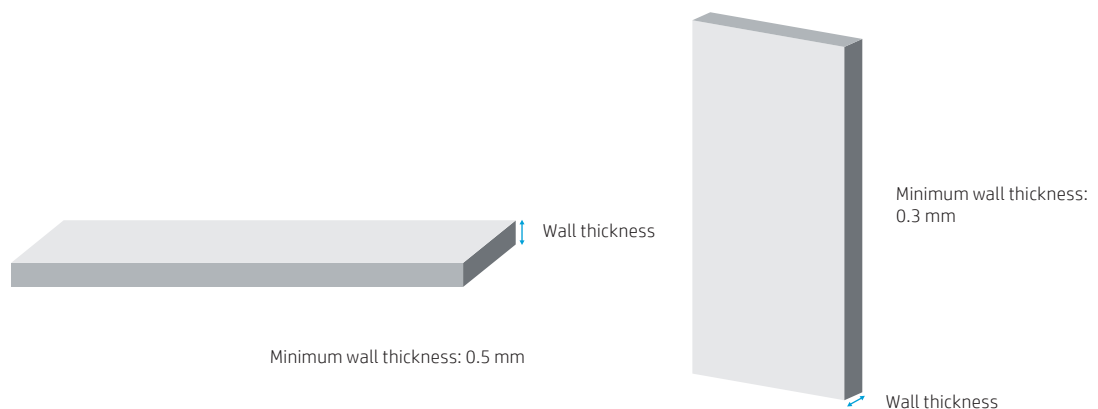

Figure 1. Minimum wall thickness

Cantilevers

When printing a cantilever, the minimum wall thickness depends on the aspect ratio, which is the length divided by the width. For a cantilever with a width of less than 1 mm, the aspect ratio should be less than 1. There are no specific recommendations for widths of 1 mm or larger. For parts with a high aspect ratio, it is recommended to increase the wall thickness or to add ribs or fillets to reinforce the part.

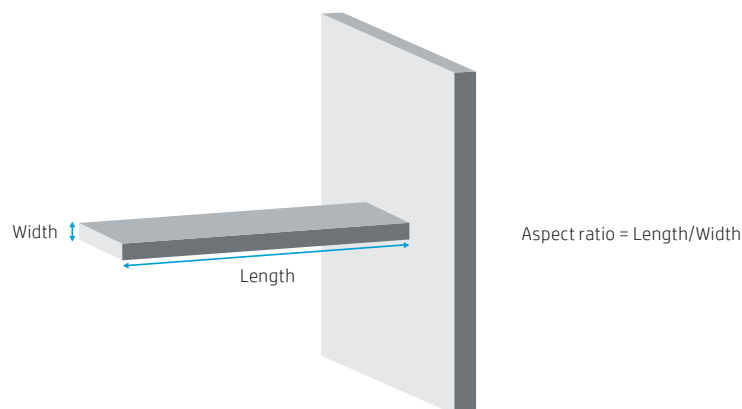

Figure 2. Cantilevers

Connecting parts

Sometimes a pair of printed parts need to fit together to form the final application. To ensure correct assembly, the minimum gap between the interface areas of these parts should be at least 0.4 mm (± 0.2 mm of tolerance for each part).

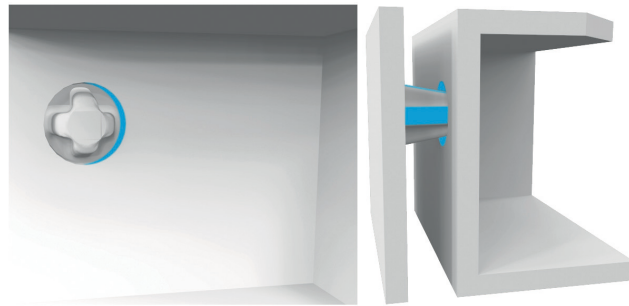

Figure 3. Minimum gap between connecting parts

Moving parts

As a general rule, spacing and clearance between faces of printed as assemblies should be a minimum of 0.7 mm.

Parts with walls with a minimum thickness of 30 mm should have a larger gap between each side to ensure proper performance.

For parts with walls that are thinner than 3 mm, the clearance between parts printed as assemblies can be as low as 0.3 mm, but this fully depends on the design, and iterations with the manufacturer may be necessary to ensure quality performance.

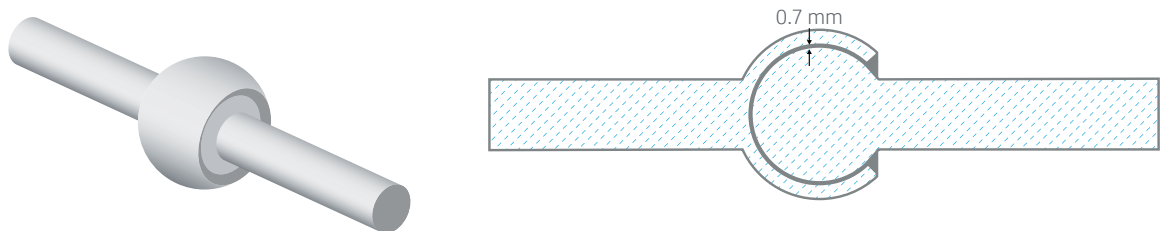

Figure 4. Minimum gap between moving parts

Thin and long parts

Thin and long parts are susceptible to non-uniform cooling, which may cause uneven shrinkage along the printed part, creating a distortion in a certain direction that deviates from the nominal shape.

As a rule of thumb, any part with an aspect ratio—length vs. width—higher than 10:1, or any part with an abrupt change in its cross-section or a predominantly long and thin curved segment is susceptible to exhibiting warpage as shown in the image below:

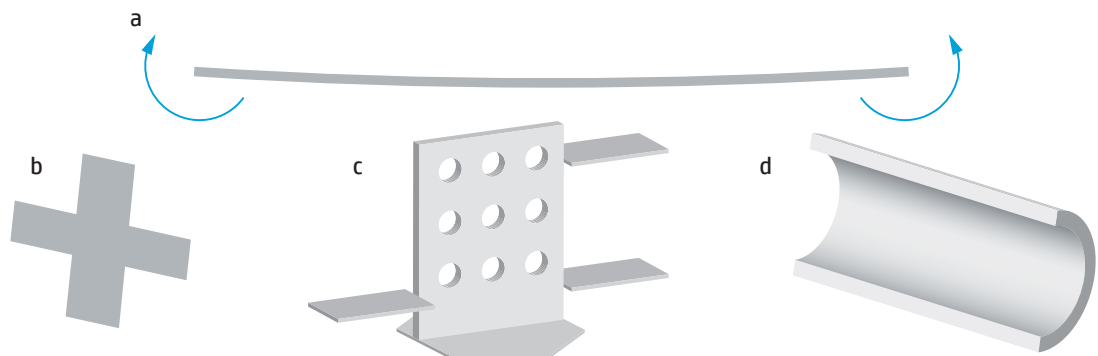

Figure 5. Part categories susceptible to shrinkage-induced warpage (a) include: thin and long parts (b), parts with abrupt changes in cross-sections (c), and thin curved surfaces (d)

To minimize the possibility of this deformation, there are several recommendations to keep in mind when designing the part:

- Increase the thickness of long walls to reduce their aspect ratios.
- Avoid ridges and ribs on large, flat areas.
- Re-design parts with high potential stresses and smoothen their cross-section transitions.
- Lighten the parts by hollowing them or by adding internal lattices.

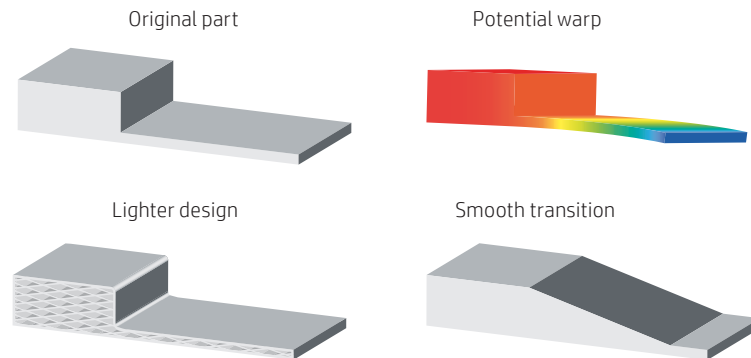

Figure 6. Warpage mitigation strategies

Design optimization strategies: Solid part or structural fill

HP Multi Jet Fusion technology allows for the printing of topology-optimized, generative designs or even small lattice structures. This kind of design allows for the creation of thinner sections, which accumulate and re-radiate less heat, improving the dimensional accuracy and general look and feel of the parts.

It also helps to reduce the weight of the part, the quantity of material, and the fluid agent used compared with fully solid designs, which not only reduces the cost of the part but also helps reduce the operating cost in applications that are very weight-sensitive.

Hollow parts

This design optimization strategy involves hollowing the model through an automatic process. (Professional software such as SolidWorks, Materialise Magics with Materialise Build Processor for HP Multi Jet Fusion technology, and Autodesk® Netfabb® have this built in.)

The minimum recommended wall thickness is 2 mm, but higher mechanical properties are achieved with thicker walls. The optimum choice is dependent upon the application.

Once the model has been printed, drain holes can be implemented in the hollow part to remove the trapped unfused powder. Otherwise, trapped unfused powder can remain within the part, which results in heavier and more resistant parts compared with the fully hollow option. While the part is still light, it is weaker than the non-hollowed version. The difference in weight stems from the different densities of fused and unfused material.

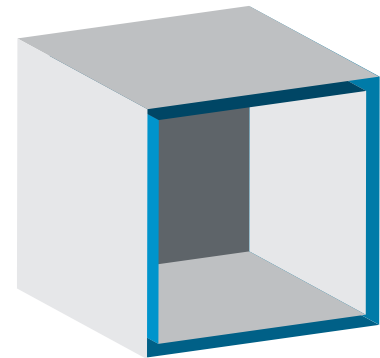

Figure 7. Example of hollow part



Leaving the powder trapped within a part also saves post-processing time since powder extraction is not required.

Lattice structures

This design optimization strategy involves hollowing a part and replacing the internal solid mass with a lattice structure that provides mechanical integrity via the collective action of many rigid cells while still noticeably reducing the part's mass and cost.

This re-design is also a fast process that can be automated with professional software such as Materialise Magics or nTopology.

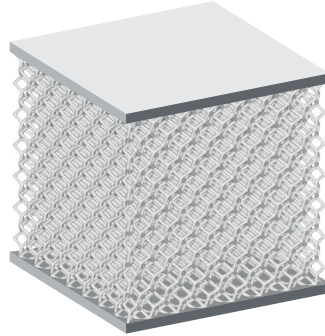

Figure 8. Example of lattice structure

Topology optimization

Topology optimization is a finite element method (FEM)–based process that finds the best distribution of material given an optimization goal and a set of constraints. Typical optimization goals are mass reduction and creating specific mechanical properties. This process requires the designer to know the part's function and load distribution in depth but provides the most optimized method of reducing weight and cost from the original design.



HP part optimized
by Autodesk with Netfabb

Figure 9. Example of topology optimization



Design for accuracy

Design for HP MJF: Design guidelines

Introduction

To avoid issues with parts and to achieve maximum accuracy when designing with HP Multi Jet Fusion (MJF) technology, there are certain specifications to bear in mind.

Dimensional accuracy

When designing parts with HP Multi Jet Fusion technology, it is possible to achieve accuracy values of IT Grade 13, with Cpk values that rival those of plastic Injection Molding.

Minimum specifications for parts

The minimum printable features in planes X, Y, and Z are as follows:

Minimum hole diameter at a thickness of 1 mm	0.5 mm
Minimum shaft diameter at a height of 10 mm	0.5 mm
Minimum printable font size for embossed or debossed letters or numbers	6 pt
Minimum printable features or details (width)	0.1 mm
Minimum clearance at thickness of 1 mm	0.5 mm
Minimum slit between walls/embossed details	0.5 mm

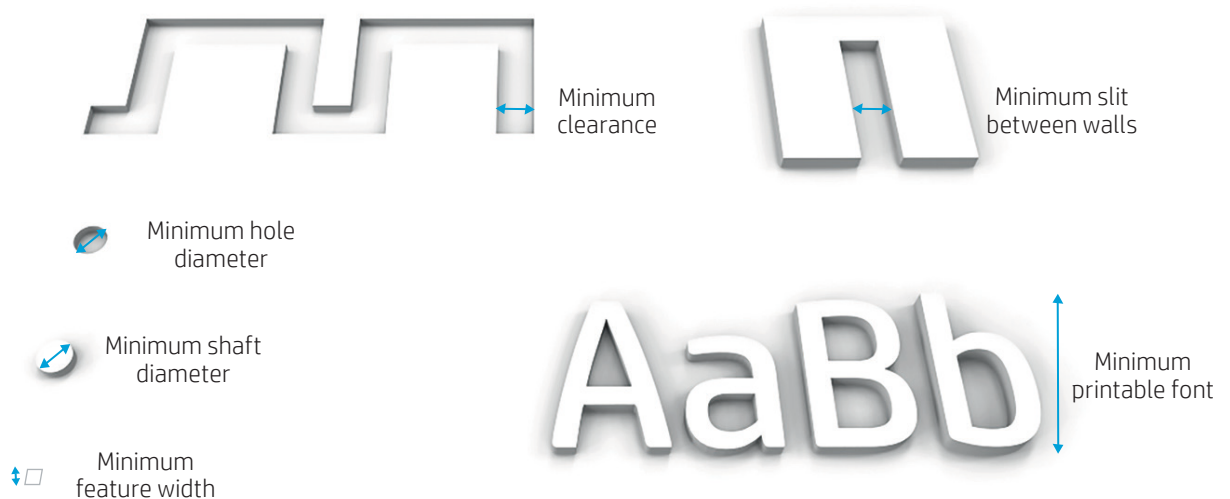
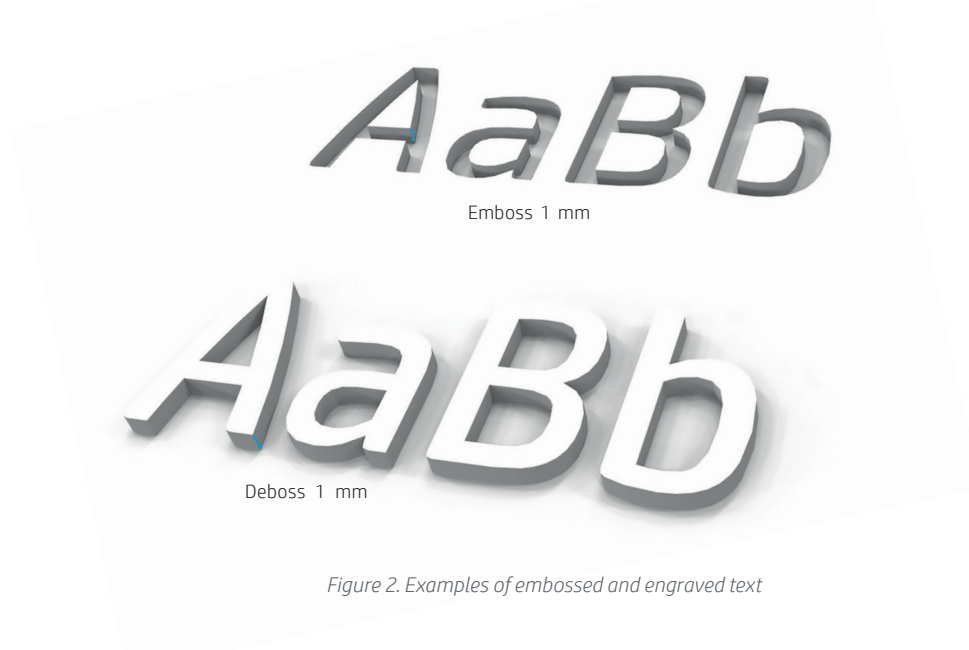

Figure 1. Minimum specification for parts

Embossed and engraved details

HP Multi Jet Fusion technology allows users to print embossed and engraved details such as letters and drawings with very high resolutions and definitions.

For the best possible output, any text, number, or drawing included in a part should have a depth or height of at least 1 mm.



Designing for accuracy guidelines

- When possible, place small features with critical dimensions—such as pins, holes, and raised texts—in the same plane.
- Design parts with a smooth cross-section transition.
- When possible, design lighter parts by hollowing them or adding internal lattices.
- Avoid long, thin, flat parts with an aspect ratio—length vs. width—higher than 10:1.
- Avoid design parts with predominantly long and thin curved segments.
- Avoid ridges and ribs on large, flat areas.



Design for aesthetics

Design for HP MJF: Design guidelines

Introduction

To print parts with optimal appearance and material properties, there are certain specifications to bear in mind.

Stair-stepping effect

All layer-by-layer manufacturing technologies require a discretization of their Z dimensions according to the layer thickness. The visibility of these layers depends mainly on their thicknesses and printing angles.

HP Multi Jet Fusion (MJF) technology uses layers of only $80\ \mu\text{m}$ ($0.080\ \text{mm}$), which are difficult to see with the naked eye in most situations. However, for small angles in the part, layered steps could become visible.

Thus, when designing parts with protruding features, it is recommended to keep angles above 20° between big, flat areas and the XY plane if they will be facing upward. Surfaces that face downward are typically exempt from stepping as long as they are oriented and avoid angles less than 5° to 10° .

These values, however, are general indications and ultimately depend on the application. For optimum results, the best solution is to try several options and choose the one that yields the better look and feel.

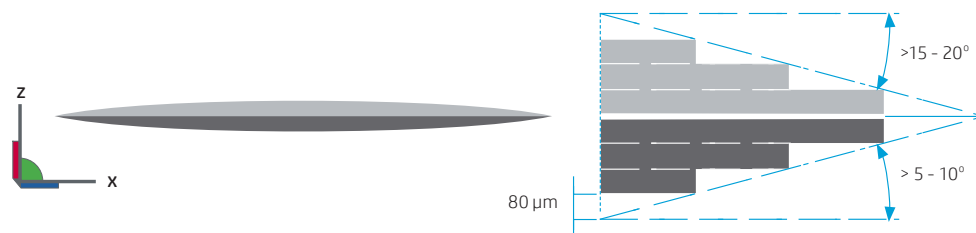

Figure 1: Stair-stepping effect

Designing for aesthetics guidelines

- When possible, place small features with critical dimensions—such as pins, holes, and raised texts—in the same plane, taking into account that areas printed facing downward would have a better look and feel than those that face upward.
- Design parts with a smooth cross-section transition.
- When possible, add internal lattices or hollow the parts to achieve a lighter design.
- Avoid long, thin, flat parts with an aspect ratio—length vs. width—higher than 10:1.
- Avoid designing parts with a predominantly long and thin curved segment.
- Avoid ridges and ribs on large, flat areas.





Design for cleaning

Design for HP MJF: Design guidelines

Introduction

Ease of cleaning is one of the advantages of HP Multi Jet Fusion technology compared with other 3D printing technologies. However, in terms of 3D printing production, designers should take into account several recommendations in order to facilitate the cleaning process and minimize the cost once the part is printed.

Drain holes

When printing hollow parts, add at least two drain holes on opposite faces of the part for efficient powder removal, which is critical to obtain the largest weight reduction. The minimum recommended diameter of the drain holes is 5 mm.

Lattice structures

Unfused powder can be difficult to remove from a part through drain holes when a part has a lattice structure inside. Therefore, it is recommended to leave the powder trapped inside or to leave the lattice partially open. The minimum gap recommended in a lattice structure to ensure that the material inside the part can be removed is 5 mm.

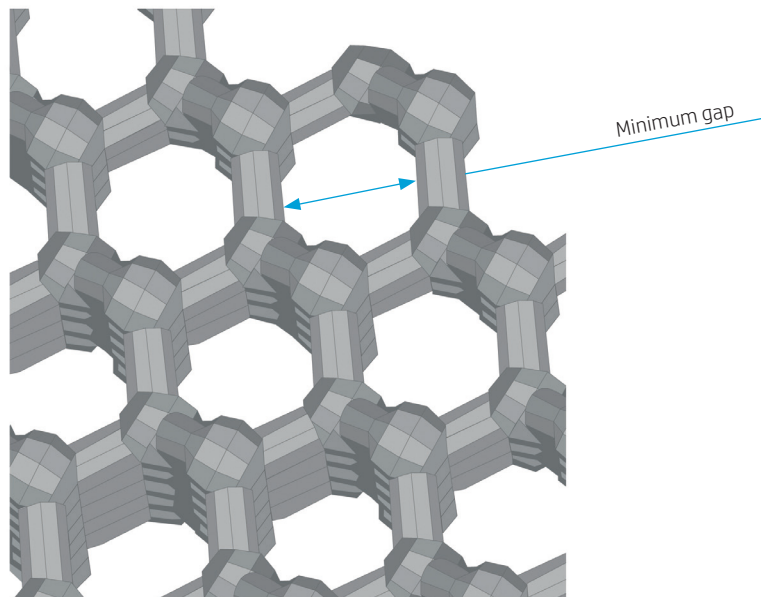

Figure 1. Minimum gap for lattice structures

Ducts

To remove material from narrow ducts, design and print a strip or a chain through the duct. When the part has been printed, the chain can be pulled out to dislodge most of the material. Any remaining material can be removed through the normal cleaning process.



Figure 2. Duct cleaning

For ducts narrower than 5 mm, clean the inside with a flexible screw once the part has been printed. To improve the flexible screw cleaning performance, it can be attached to a drill.

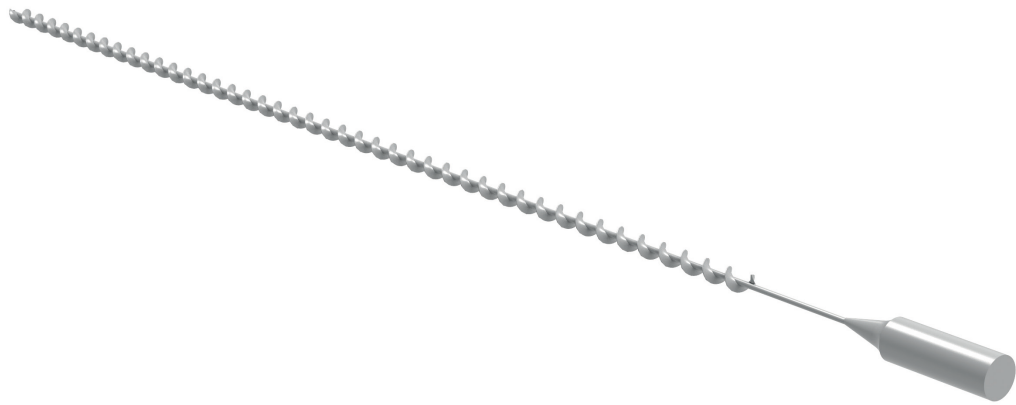

Figure 3. Flexible screw



Dimensional tolerancing

Design for HP MJF: Union joints design

Introduction

HP Multi Jet Fusion technology allows for the designing and printing of parts that can be assembled between them or to other manufactured parts, such as metal parts, to create final products and functional assemblies. The parts can be joined by union joints such as self-tapping screws, threaded inserts, or snap-fits.

It is important to consider tolerances at an early stage of the product development process and to design every part involved in a final product or functional assembly taking into account the permissible range of variation in dimensions to ensure that it fits suitably and works according to the design intent.

Depending on how the parts must interact to create a final product or achieve the assembly’s functional needs, the required tolerances will be tighter or wider, which will require the most capable manufacturing process to produce the part with suitable accuracy.

International Tolerance (IT) Grades

Designing a part often involves the use of the International Tolerance Grades defined in ISO 286, which provide a standardized reference for typical manufacturing process capability in terms of tolerance accuracy for a given dimension.

The most common manufacturing processes have an associated IT Grade that specifies their capability to provide accurate parts, as shown in the image below:

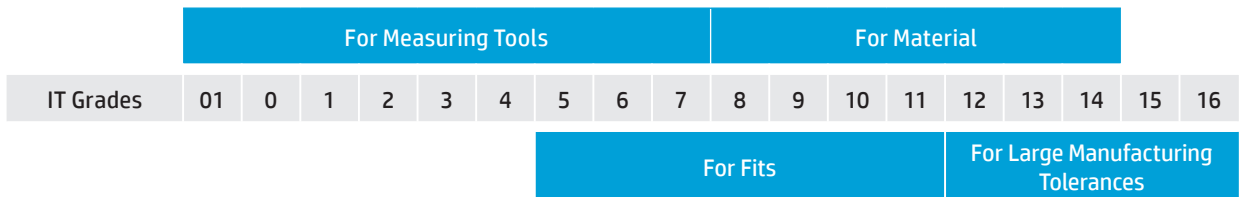

Figure 1: International Tolerance (IT) Grades

Each IT Grade establishes the allowable tolerance limits for a given dimension. As shown in the following table, a smaller IT Grade provides tighter tolerances:

Standard tolerance grades	Values of standard tolerance (mm)								Nominal size (mm)
	from: 1 to: 3	3 to: 6	6 to: 10	10 to: 18	18 to: 30	30 to: 50	50 to: 80	80 to: 120	
1	0,0015	0,0015	0,0015	0,0015	0,0015	0,002	0,002	0,003	Measuring tools
2	0,002	0,002	0,002	0,002	0,002	0,003	0,003	0,004	
3	0,003	0,003	0,003	0,003	0,004	0,004	0,005	0,006	
4	0,004	0,004	0,004	0,005	0,006	0,007	0,008	0,010	
5	0,005	0,005	0,006	0,008	0,009	0,011	0,013	0,015	Engineering fits, bearings, machining processes (grinding, turning)
6	0,007	0,008	0,009	0,011	0,013	0,016	0,019	0,022	
7	0,009	0,012	0,015	0,018	0,021	0,025	0,030	0,035	
8	0,014	0,018	0,022	0,027	0,033	0,039	0,046	0,054	
9	0,025	0,030	0,036	0,043	0,052	0,062	0,074	0,087	
10	0,040	0,048	0,058	0,070	0,084	0,100	0,120	0,140	
11	0,060	0,075	0,090	0,110	0,130	0,160	0,190	0,220	Large manufacturing, die casting, stamping, sand casting
12	0,090	0,120	0,150	0,180	0,210	0,250	0,300	0,350	
13	0,140	0,180	0,220	0,270	0,330	0,390	0,460	0,540	
14	0,250	0,300	0,360	0,430	0,520	0,620	0,740	0,870	
15	0,400	0,480	0,580	0,700	0,840	1,000	1,200	1,400	
16	0,600	0,750	0,900	1,100	1,300	1,600	1,900	2,200	
17	0,900	1,200	1,500	1,800	2,100	2,500	3,000	3,500	
18	1,400	1,800	2,200	2,700	3,300	3,900	4,600	5,400	

Table 1: Standard tolerance grades

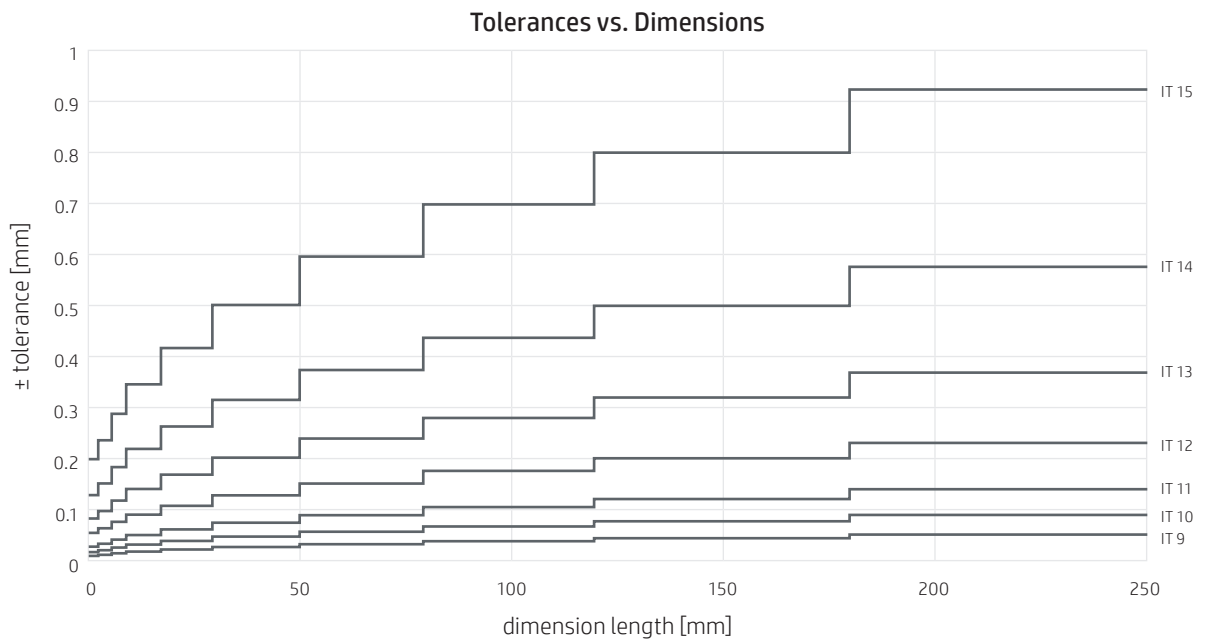

Figure 2: Graph of International Tolerance (IT) Grades

General plastic Injection Molding is typically capable of tolerances equivalent to an IT grade between 12 and 15. Precision plastic Injection Molding requires more costly detailed mold refinement, but is capable of tolerances equivalent to IT grades between 8 and 11.

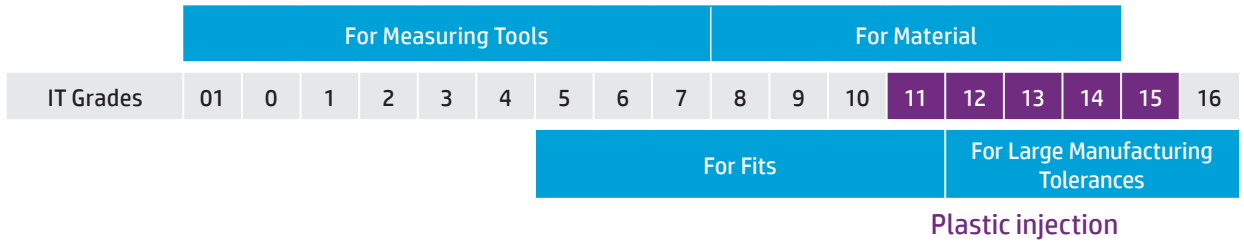

Figure 3: Plastic injection-equivalent IT Grades

HP MJF dimensional tolerancing

When designing parts with HP Multi Jet Fusion technology, it is possible to achieve accuracy values of IT Grade 13, with Cpk values that compete with plastic Injection Molding

According to the International Tolerance Grades defined in ISO 286, this range of variation in dimensions is equivalent to an IT Grade of 13.

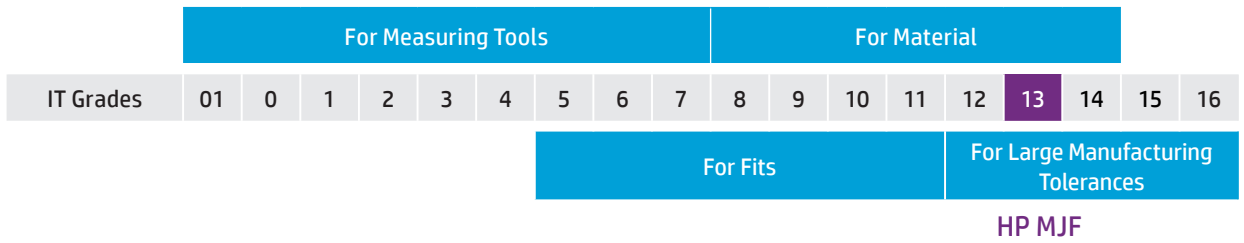

Figure 4: HP MJF-equivalent IT Grade

©Copyright 2019 HP Development Company, L.P. The information contained herein is subject to change without notice.

The information contained herein is provided for information purposes only. The only terms and conditions governing the sale of HP 3D printer solutions are those set forth in a written sales agreement. The only warranties for HP products and services are set forth in the express warranty statements accompanying such products and services. Nothing herein should be construed as constituting an additional warranty or additional binding terms and conditions. HP shall not be liable for technical or editorial errors or omissions contained herein and the information herein is subject to change without notice.





Types of fits

Design for HP MJF: Union joints design

Introduction

HP Multi Jet Fusion technology allows users to print mating parts to create functional assemblies. When designing mating parts with the suitable tolerance and type of fit, it is important to save time in post-processing and assembly operations.

Fits are used to establish tolerances between inner and outer features of bearings, bushings, shafts, or drilled holes, and are often represented as a shaft and a hole, although they include other parts that are not only cylindrical.

There are two types of fits based on the allowable limits for shaft and hole size:

Clearance fit

A clearance fit leaves a space or clearance between mating parts: The hole diameter is larger than the shaft diameter. The shaft can slide and/or rotate in the hole when assembled, requiring no force.

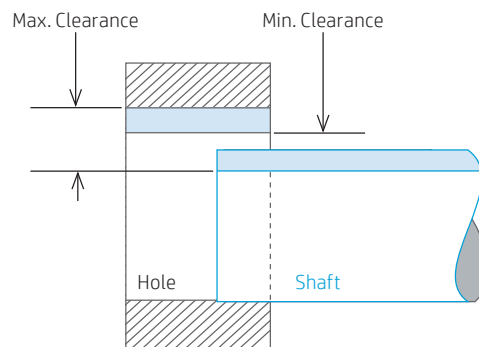

Figure 1: Clearance fit

In this type of fit, the maximum clearance is the difference between the maximum size of the hole and the minimum size of the shaft, while the minimum clearance is the difference between the minimum size of the hole and the maximum size of the shaft.

Interference fit

In an interference fit the hole diameter is smaller than the shaft diameter. This type of fit does not allow relative motion between mating parts, providing a strong connection and requiring strong force in assembly and disassembly.

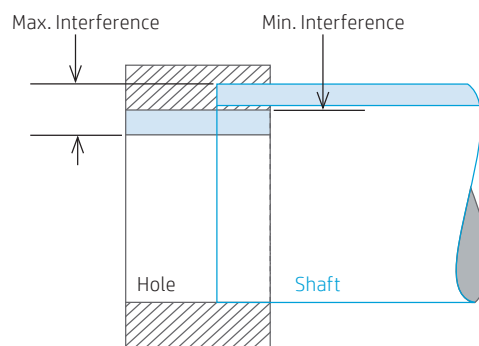

Figure 2: Interference fit

In this type of fit the maximum interference is the difference between the maximum size of the shaft and the minimum size of the hole, while the minimum interference is the difference between the minimum size of the shaft and the maximum size of the hole.

Design guidelines

Depending on how the mating parts must fit to achieve the assembly’s functional needs, the required tolerances will be tighter or wider, which will determine whether additional post-processes, such as machining, are required to achieve suitable accuracy.

Standard fits

There are international standards in the metric system—ISO 286 and ANSI B4.2—and the imperial system—ANSI B4.1—that define the allowable tolerance limits that should be used depending on the type of fit required.

It is common to use the International Tolerance Grades defined in ISO 286, which provide a reference for typical manufacturing process capability in terms of tolerance accuracy, as shown in the following table:

Plastic injection																		
For Measuring Tools																		
For Material																		
IT Grades	01	0	1	2	3	4	5	6	7	8	9	10	11	12	13	14	15	16
For Fits													For Large Manufacturing Tolerances					
HP MJF																		

Table 1: IT grades

Each IT grade establishes the allowable tolerance limits for a given dimension. As shown in the following table, a smaller IT grade provides tighter tolerances:

Standard tolerance grades	Values of standard tolerance (mm)									Nominal size (mm)
	from: 1 to: 3	3 to: 6	6 to: 10	10 to: 18	18 to: 30	30 to: 50	50 to: 80	80 to: 120	120 to: 180	
1	0,0015	0,0015	0,0015	0,0015	0,0015	0,002	0,002	0,003		Measuring tools
2	0,002	0,002	0,002	0,002	0,002	0,003	0,003	0,004		
3	0,003	0,003	0,003	0,003	0,004	0,004	0,005	0,006		
4	0,004	0,004	0,004	0,005	0,006	0,007	0,008	0,010		
5	0,005	0,005	0,006	0,008	0,009	0,011	0,013	0,015		Engineering fits, bearings, machining processes (grinding, turning)
6	0,007	0,008	0,009	0,011	0,013	0,016	0,019	0,022		
7	0,009	0,012	0,015	0,018	0,021	0,025	0,030	0,035		
8	0,014	0,018	0,022	0,027	0,033	0,039	0,046	0,054		
9	0,025	0,030	0,036	0,043	0,052	0,062	0,074	0,087		
10	0,040	0,048	0,058	0,070	0,084	0,100	0,120	0,140		
11	0,060	0,075	0,090	0,110	0,130	0,160	0,190	0,220		
12	0,090	0,120	0,150	0,180	0,210	0,250	0,300	0,350		Large manufacturing, die casting, stamping, sand casting
13	0,140	0,180	0,220	0,270	0,330	0,390	0,460	0,540		
14	0,250	0,300	0,360	0,430	0,520	0,620	0,740	0,870		
15	0,400	0,480	0,580	0,700	0,840	1,000	1,200	1,400		
16	0,600	0,750	0,900	1,100	1,300	1,600	1,900	2,200		
17	0,900	1,200	1,500	1,800	2,100	2,500	3,000	3,500		
18	1,400	1,800	2,200	2,700	3,300	3,900	4,600	5,400		

Table 2: Standard tolerance grades

Usually, the most common types of fits require very tight tolerances that cannot be achieved by designing and printing the part directly, and additional post-processes, such as machining, are required to achieve suitable accuracy.

Thus, there are some recommendations for designing a part that will need to be machined after printing to achieve the tight tolerances required. These recommendations include accurate holes and bearing housings.

Accurate holes

Depending on how the hole is machined, a pre-hole or pilot hole can be designed into the part to guide the drill bit to the appropriated location. If the part is machined directly with a drill bit size equal to the final required hole diameter, it is recommended to machine the part without a designed pre-hole, letting the CNC Machine create the pre-hole to ensure proper positioning of the drill.

When it is necessary to machine a hole with a larger diameter than the available drill head, it will need to be machined by interpolating. In this case, a pre-hole or pilot hole can be designed into the part, where the required diameter must be at least 1 mm smaller than the final hole diameter.

Bearing housing

In applications where fitting a bearing is required, it is recommended to machine it, interpolating with a smaller drill and then adjusting it to the required tolerance. Like the case mentioned above, a pre-hole can be designed to save material, where the required diameter must be at least 1 mm smaller than the final diameter to ensure a proper finish.



Figure 3: Bearings inserted into an HP MJF part

Customized fits

When designing mating parts to create functional assemblies with a non-required standard fit, it is recommended to consider the following design guidelines:

- To print a clearance fit: When inserting a metal shaft into an HP MJF part hole, the minimum clearance must be as follows:

Clearance between mating parts > maximum size of the metal shaft + minimum size of the HP MJF part hole

- To print an interference fit: When inserting a metal pin into an HP MJF part hole, the minimum interference must be as follows:

Interference between mating parts > minimum size of metal pin+ maximum size of the HP MJF part hole

©Copyright 2019 HP Development Company, L.P. The information contained herein is subject to change without notice.

The information contained herein is provided for information purposes only. The only terms and conditions governing the sale of HP 3D printer solutions are those set forth in a written sales agreement. The only warranties for HP products and services are set forth in the express warranty statements accompanying such products and services. Nothing herein should be construed as constituting an additional warranty or additional binding terms and conditions. HP shall not be liable for technical or editorial errors or omissions contained herein and the information herein is subject to change without notice.





Threaded unions

Design for HP MJF: Union joints design

Introduction

The most widely used types of joints are screws and threaded parts because they can be disassembled several times and create strong and durable joints. The use of threads in plastic parts is common in the design of caps and customized fasteners or to join tubes.

General recommendations

HP Multi Jet Fusion technology allows users to print external and internal threads inside the part, eliminating the need for mechanical thread-forming operations.

It is recommended to print external and internal threads in sizes larger than 6 mm (M6 or ¼ inch per the Imperial system) to achieve favorable results in all printing orientations. If a small thread (less than 6 mm) is needed, it is recommended to use self-tapping screws, threaded inserts, or to machine the thread for the small tolerances required in these sizes.



Tolerances are dependent upon the material, print mode, and post-processing selected. For this reason, it is recommended to first validate the design with different offsets before printing multiple parts.

Design guidelines

Self-tapping screws

Although HP Multi Jet Fusion technology allows for the printing of small features such as external and internal threads inside the part, when a small thread (up to 6 mm) is needed, it is recommended to use self-tapping screws, which tap their own threads as they are driven into the part. Certain types of self-tapping screws require a pre-formed hole, the dimensions of which can be recommended by the screw supplier.



Figure 1: Self-tapping screw

Machined threads

Another alternative when a small thread (up to 6 mm) is needed is to machine the part after printing it in order to achieve the required accuracy. The tools recommended for machining HP Multi Jet Fusion parts are the same as other technical plastics. Although not recommended, tools for machining metals like steel or aluminum may also be used.



A standard machining process can achieve dimensional tolerances up to ± 0.05 mm.

Internal threads

To machine an internal thread, it is necessary to start from a pre-formed hole and then machine the thread using the required tap. To design the pre-hole on the printed part, designers can refer to usual drill size recommendations for plastic and metal. For example, drill size recommendations for metric plastic threads are shown in the following table:

1. ISO Standard metric threads

ISO Metric thread size	Drill size (mm)
M3	2,5
M4	3,3
M5	4,2
M6	5
M8	6,8
M10	8,5
M12	10,2
M16	14
M20	17,5
M24	21
M30	26,5
M36	32
M42	37,5
M48	43
M50	47
M56	50,5

2. ISO Fine metric threads

ISO Metric thread size	Drill size (mm)
M3 x 0,35	2,65
M4 x 0,5	3,5
M5 x 0,5	4,5
M6 x 0,75	5,2
M8 x 1	7
M10 x 1,25	8,8
M12 x 1,25	10,8
M16 x 1,5	15,4
M20 x 1,5	18,5
M24 x 2	22
M30 x 2	28
M36 x 3	33

3. Whitworth threads

Thread size (inches)	Drill size (mm)	
	BSW	BSP
1/16	1,2	--
3/32	1,8	--
1/8	2,6	8,9
5/32	3,1	--
3/16	3,6	--
7/32	4,4	--
1/4	5,1	11,9
5/16	6,5	--
3/8	7,9	15,4
1/2	10,5	19
5/8	13,5	--
3/4	16,5	24,7
7/8	19,3	28,4
1	22	30,8
1 1/8	24,8	35,5
1 1/4	27,8	39,4
1 3/8	30,5	42
1 1/2	33,5	45,4

Table 1: Drill size recommendations for plastic threads

Usually when machining metal parts, a set of three taps must be used to complete the process. With HP plastic materials, this can be reduced and only the final tap is needed due to the low hardness of HP material compared with the steel material of the tap.



Figure 2: HP MJF pre-formed hole testing

External threads

To machine an external thread, it is necessary to start from a solid printed cylinder and then machine the thread using the required die. The diameter of the cylinder to be machined must be slightly smaller than the die's major diameter. Typical cylinder diameter recommendations for plastic and metal are applicable.



Figure 3: Metric die

Standard printed threads

To ensure a satisfactory assembly operation with HP Multi Jet Fusion technology, there are a few recommendations when designing threads larger than 6 mm under international standards (e.g., DIN 13-1, ISO 965-2, ANSI/ASME B1.1). These international standards usually specify tolerances relative to diameter and pitch of a thread.

When designing internal threads, the less restrictive tolerance values (maximum tolerance values) should be used, and when designing external threads, more restrictive tolerance values (minimum tolerance values) should be used. For example, when designing metric threads under the ISO 965-2 standard—threads with general-purpose tolerances (6H-6g) and normal engagement length—the recommended design values are shown in the following table:

Thread	Pitch	Internal threads - 6H					External threads - 6g					
		ØD		Pitch Diameter Ø		Minor Diameter Ø	Major Diameter Ø		Pitch Diameter Ø		Minor Diameter Ø	
		min.	max.	min.	max.	min.	max.	min.	max.	min.	max.	
M8	1.25	8	7.188	7.348	6.647	6.912	7.972	7.760	7.160	7.042	6.438	6.272
M10	1.5	10	9.026	9.206	8.376	8.676	9.968	9.732	8.994	8.862	8.128	7.938
M12	1.75	12	10.863	11.063	10.106	10.441	11.966	11.701	10.829	10.679	9.819	9.602
M16	2	16	14.701	14.913	13.835	14.210	15.962	15.682	14.663	14.503	13.508	13.271
M20	2.5	20	18.376	18.600	17.294	17.744	19.958	19.623	18.334	18.164	16.891	16.625

Table 2: Recommended external and internal thread tolerances for HP MJF, based on ISO 965-2 tolerances

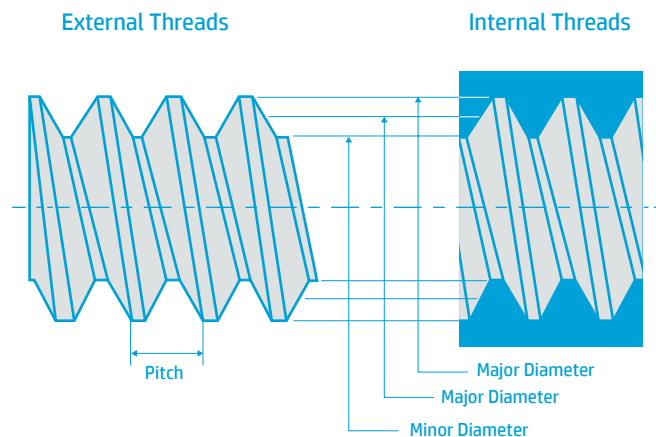

Figure 4: Features of external and internal threads

Customized threads

For customized threads, all external and internal threads should be designed with a gap of 0.2 mm to 0.4 mm between the external and the internal thread, as appropriate.

It is recommended to remove all sharp edges and apply a minimum radius of 0.1 mm when designing threads for HP Multi Jet Fusion parts.



Figure 5: Round edges for custom-printed threads

Post-processing guidelines

Threads can be considered a very fine detail and should be cleaned using a manual or automatic sandblasting machine with glass bead particles that range from 70 to 110 microns in size and 3 to 4 bars in terms of pressure. For cases in which a vibratory finishing (tumbling) is required to improve surface roughness in other areas, it is recommended to first clean the threads using a sandblasting machine. Usually the media used in vibratory finishing are too big to clean the space between the threads.



It is more difficult to clean internal threads; for this reason, it is better to reduce the length of this type of thread and make through holes when possible. For internal and external threads, it is possible to use taps and dies if they are not completely cleaned or if there is excessive friction.

Painting the threads is not recommended in any case; parts can be painted only if they are already assembled.

For this reason, dyeing is the best option for coloring threaded parts without altering the dimensional accuracy.



Inserts

Design for HP MJF: Union joints design

Introduction

Threaded inserts provide a strong, reusable, and permanent thread in plastic parts, and they are typically used when frequent assembly and disassembly are required for service or repair. Threaded inserts are often available in brass, stainless steel, and aluminum, and can be installed using various techniques (e.g., heat-staking, ultrasonic vibrations, or press-in).

Recommended inserts for HP Multi Jet Fusion

Selecting the best threaded insert type and installation technique depends on a few factors, such as part application, plastic part material, and strength requirements.

HP Multi Jet Fusion parts are made of thermoplastic materials and can be re-melted and re-formed once printed. For this reason, inserts that are installed by heat-staking and ultrasonic vibrations are recommended for thermoplastic materials due to their high overall performance; however, press-in (screw-to-expand or hexagonal-shaped) and self-threading inserts may also be used in some applications.

Type of insert		Performance
Heat-staking and ultrasonic vibrations insert		<p>High overall performance.</p> <p>Not very dependent on hole size.</p> <p>Material is melted around the insert.</p>
Press-in insert	Screw-to-expand	<p>Very dependent on hole size tolerances.</p> <p>Recommended for non-critical applications.</p>
	Hexagonal-shaped	<p>Dependent on hole size tolerances.</p> <p>Good pull-out resistance.</p> <p>Recommended for non-critical applications.</p>
Self-threading insert		<p>Excellent pull-out resistance.</p> <p>Easy to install.</p>

Table 1: Types of inserts

Design guidelines

Hole diameter

A pre-formed hole is necessary to install a threaded insert, so the hole diameter is a very important element in achieving the desired strength: Oversized holes will result in a reduction of the joint strength and undersized holes can potentially crack the part. Usually, suppliers of threaded inserts specify the hole diameter size and depth needed to install an insert.



The hole size is dependent upon the part orientation, and for this reason it is recommended to always print the part using the same orientation.

HP Multi Jet Fusion–produced parts may have dimensional variations in small features up to +/-0.2 mm (ISO 286, IT Grade 13), which is usually higher than supplier specifications. For this reason, it is important to select a type of insert that is compliant with hole deviations.

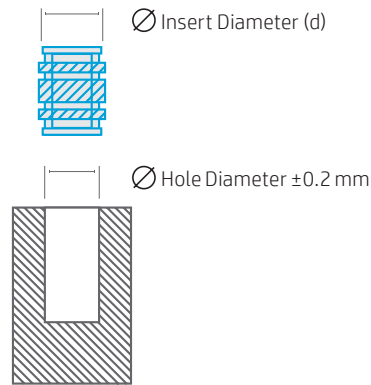

Figure 1: Hole diameter

Bosses

Bosses are typically used for mounting purposes such as attaching fasteners or as a receptacle for threaded inserts. Traditionally a boss diameter is twice the size of the external diameter of inserts that are less than 6 mm, while a 3-mm wall thickness applies to all larger inserts.

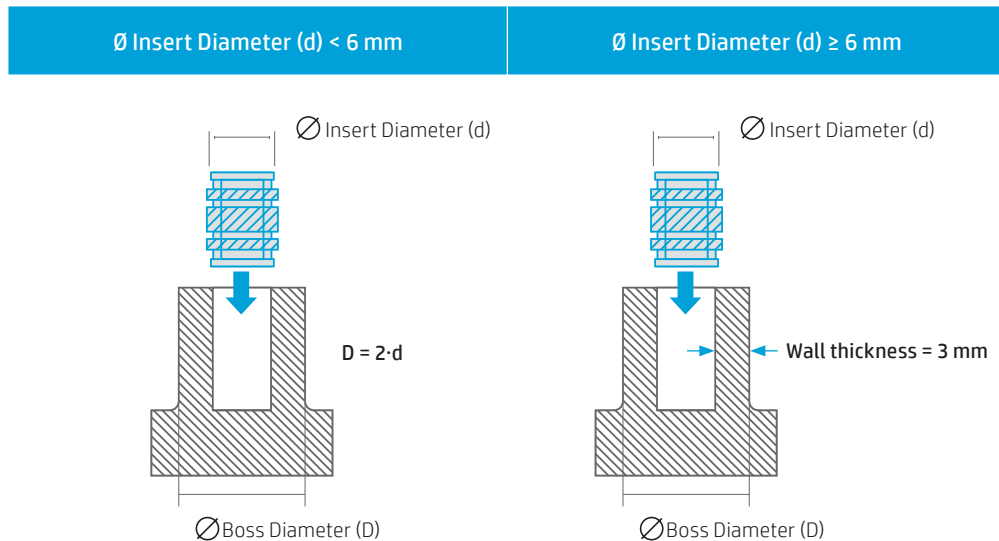

Figure 2: Boss diameter



Special consideration should be given to cold-press installations where increased stress may require larger boss diameters.

Mating part

The threaded insert—not the plastic part—should bear the load. For this reason, the diameter of the mating part hole is also important to keep the insert from being pulled through the hole.

Thus, the diameter of the mating part hole must be larger than the outside diameter of the assembly bolt but smaller than the diameter of the insert, as shown below:

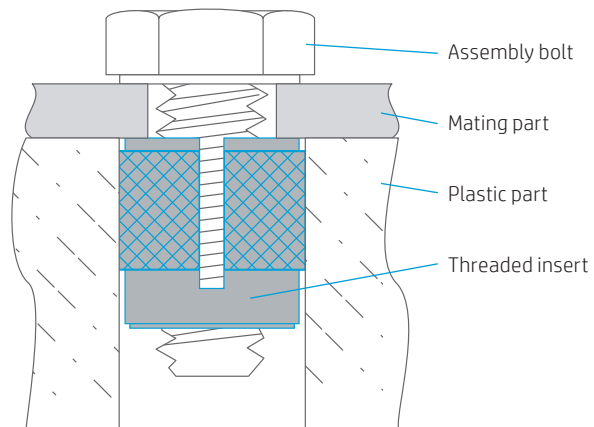

Figure 3: Threaded joint assembly



The mating part must also withstand the stress generated by the clamping force. In instances where the mating part will also be plastic, the use of a collar or a washer between the assembly bolt and the mating part should be considered.

©Copyright 2019 HP Development Company, L.P. The information contained herein is subject to change without notice.

The information contained herein is provided for information purposes only. The only terms and conditions governing the sale of HP 3D printer solutions are those set forth in a written sales agreement. The only warranties for HP products and services are set forth in the express warranty statements accompanying such products and services. Nothing herein should be construed as constituting an additional warranty or additional binding terms and conditions. HP shall not be liable for technical or editorial errors or omissions contained herein and the information herein is subject to change without notice.





Adhesive bondings

Design for HP MJF: Union joints design

Introduction

When using HP Multi Jet Fusion technology, it is sometimes necessary to split a part into different pieces and then re-join them. There are two main reasons why bonding parts together may be necessary:

Splitting big parts

Some big parts do not fit inside the build chamber of HP Jet Fusion 3D printers. Therefore, the parts can be split into several pieces and then re-assembled after printing. This can occur in the automotive industry or in applications such as jigs and fixtures, where big parts could require bonding to ensure a strong joint and achieve a proper solution.

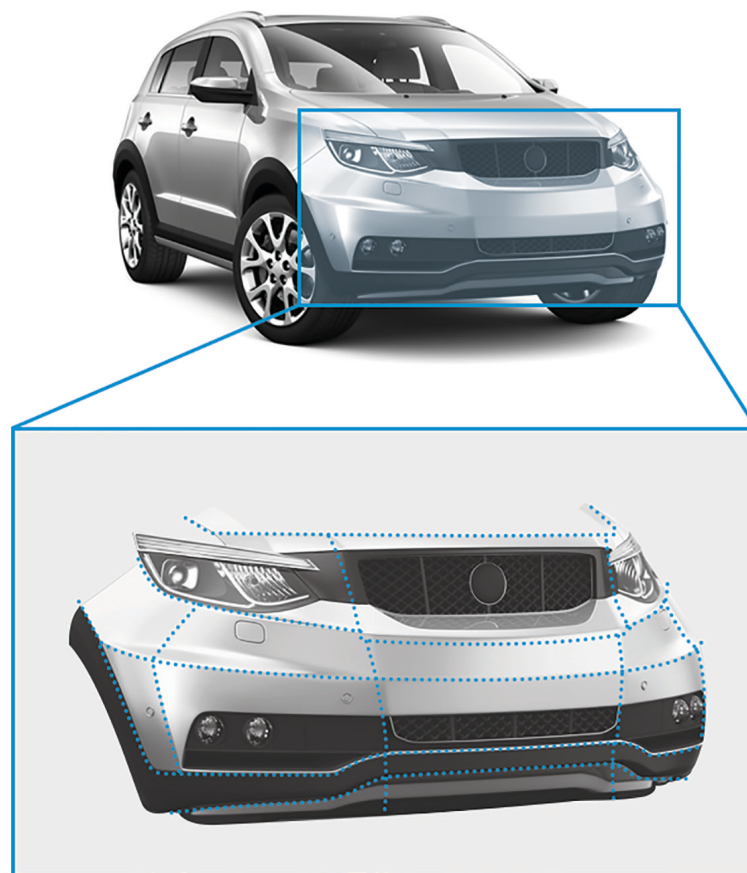

Figure 1: Bumper split proposal

Increasing packing density

The maximum printing efficiency in terms of cost and productivity is achieved by increasing the packing density. Depending on the geometry, there may be packing limitations for the achievable maximum value. In these cases, splitting the parts is a possible option.

For example, a part's packing density could be optimized by adding hinges that allow it to fold. These could be blocked after printing by using an adhesive or other mechanical locker.

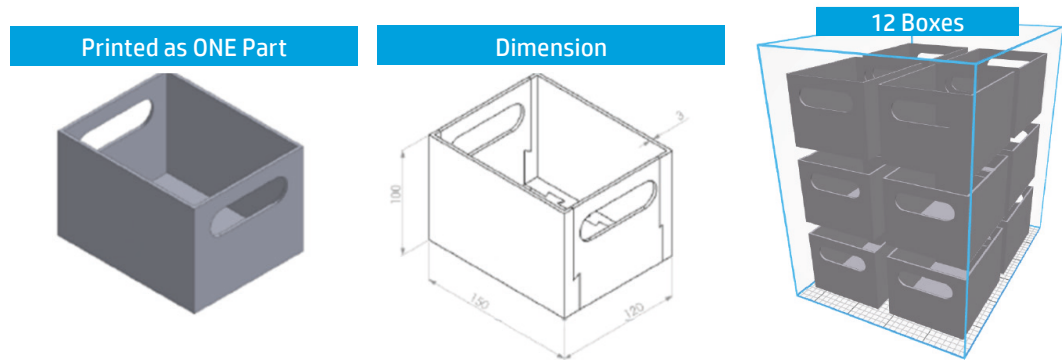

Figure 2: Example of packing density optimization: Box original design and number of parts that fit in the print bed. Data courtesy of Henkel AG & Co. KgaA

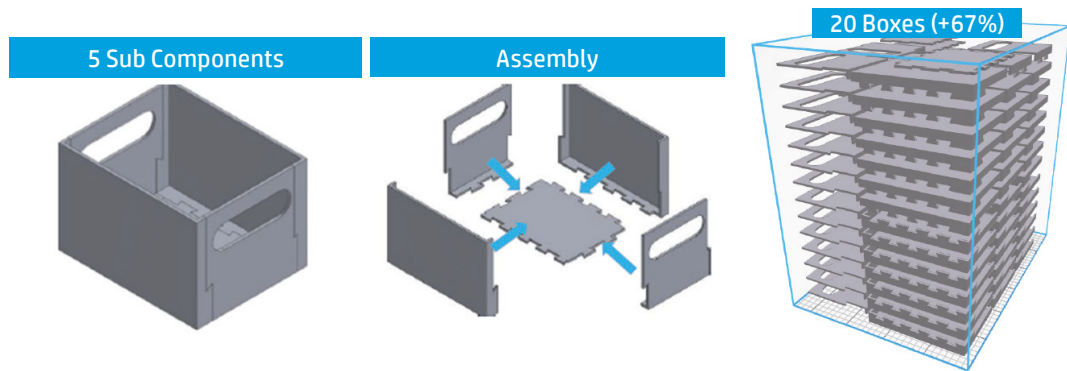

Figure 3: Example of split part to optimize packing density: With the split, the packing density increased by 67%. Data courtesy of Henkel AG & Co. KgaA

Design guidelines

Bonding robustness depends highly on the design of the union and the way the part has been split or cut into different pieces. A proper bonding design is critical for success.

Union design

The union design of the bonding is key to ensure proper performance of the bonding in the final part. The time invested in designing a proper union may depend on the final use of the pieces that will be bonded. For example, a visual prototype that will not withstand any loads would require a simple design union, while an automotive part that will be included in the final product should be designed to optimize its performance.

Design options depend on the thickness of the bonded parts and on the possibility of modifying the final geometry.

Thickness < 1.7 mm with no geometry modification allowed

One of the objectives in the design of the union is to increase the bond area as much as possible. Including features that will help reference one piece to the other during bonding will help achieve the proper position between the parts and will optimize the final result. The most recommended design option for this case is a dove or jigsaw feature, as shown below:

Dove/Jigsaw

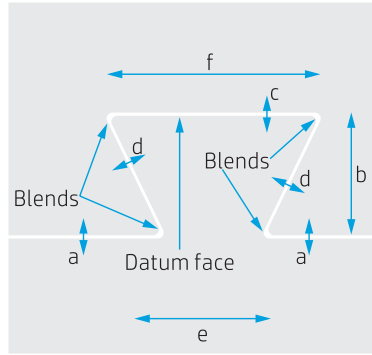
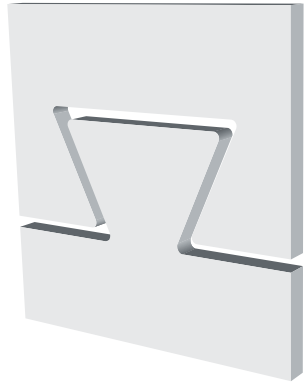

Recommended dimensions:

- a: 0.2 mm
- b: 10 mm
- c: 0-0.1 mm
- d: 0.2 mm
- e: 10 mm
- f: 20 mm

Figure 4: Dove/jigsaw design recommendations

This type of union will help increase the bonding area and, at the same time, it positions and holds both pieces that will be assembled.

There are also other design options that are simpler and will also provide satisfactory results, which could be an option for faster designs:

Square tongue

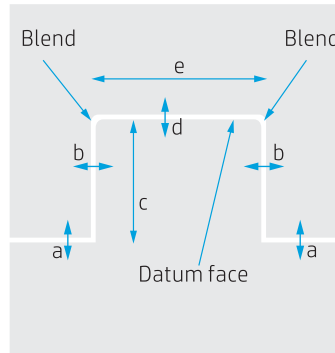
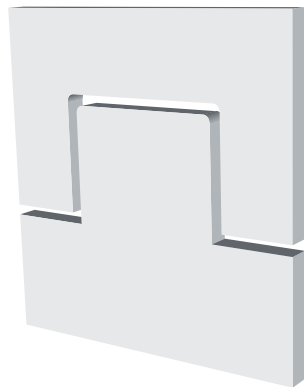

Recommended dimensions:

- a: 0.4 mm
- b: 0.2 mm
- c: 10 mm
- d: 0-0.1 mm
- e: 10 mm

Figure 5: Square tongue design recommendations

Tooth

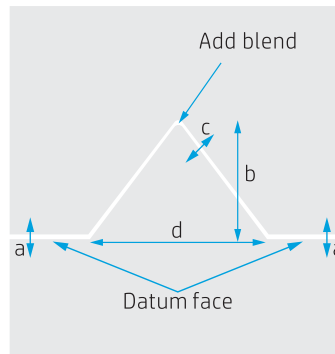
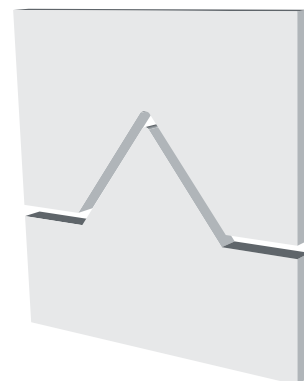

Recommended dimensions:

- a: 0-0.1 mm
- b: 10 mm
- c: 0.2 mm
- d: 20 mm

Figure 6: Tooth design recommendations

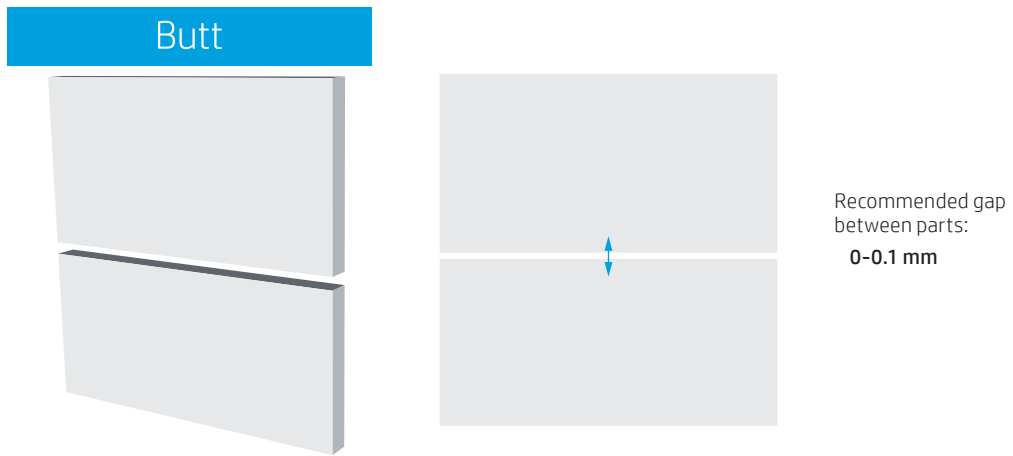

Figure 7: Butt design recommendations

When adding a union design that is not viable due to geometrical constraints (such as a dove, square tongues, or a tooth), a butt union design could be an alternative, bearing in mind that having a straight line in the bonding area is the weakest union design option due to its less-available bonding area.



All design options can be easily applied to a part using 3D software, such as Materialise Magics, or they can be directly designed using CAD software.

Thickness < 1.7 mm with geometry modification allowed

If a modification in the geometry is allowed, the bonding area can be increased and mechanically reinforced by adding an overlap between the bonded areas.

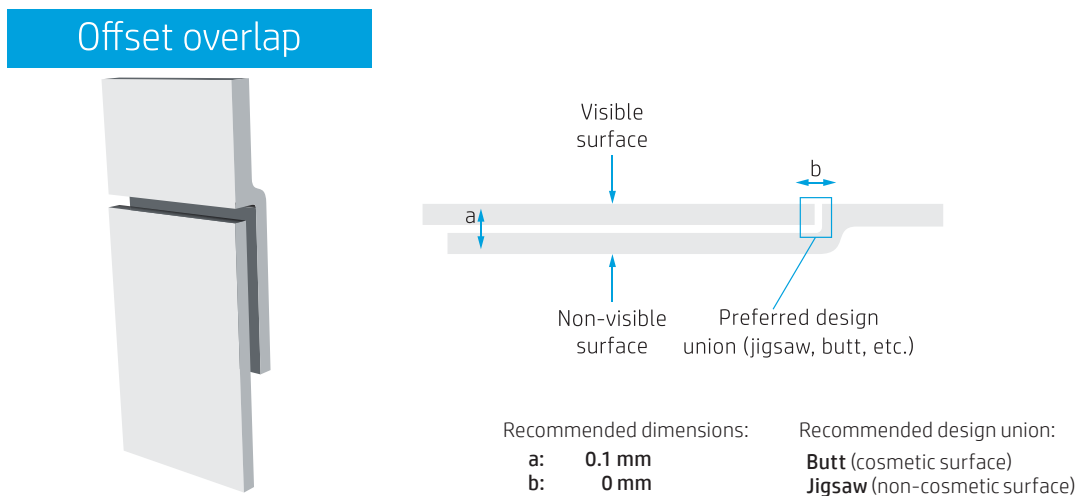

Figure 8: Offset overlap design recommendations

Thickness > 1.7 mm

When there is adequate thickness to add an overlap between the parts, it is no longer necessary to modify the final geometry to reinforce it. The improvement and optimization of the bonding union can be executed directly in the original design, thus increasing and reinforcing the bonding area.

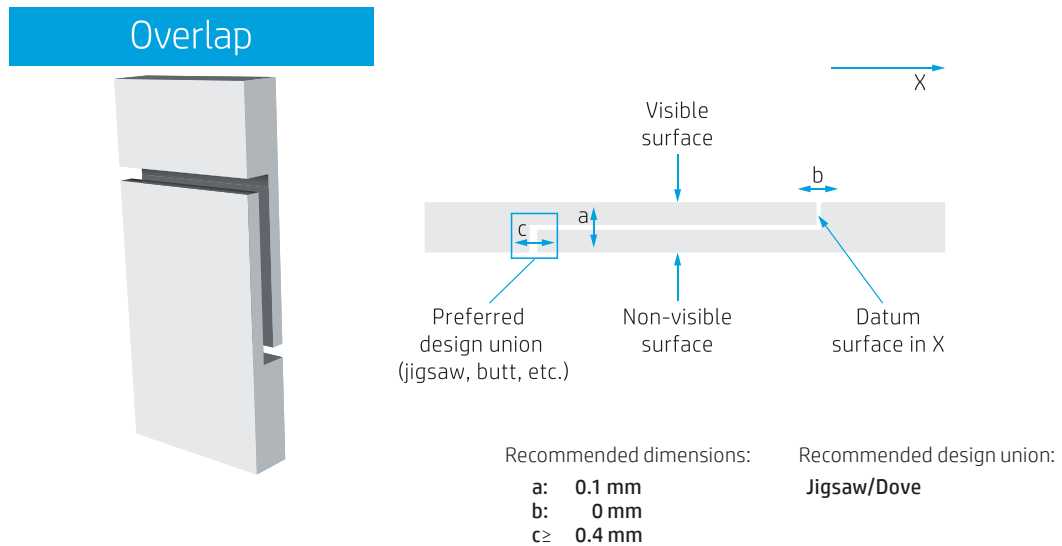

Figure 9: Overlap design recommendations

Adding more than one union feature

When the bonding line is long, it may be helpful to add multiple features that will hold both pieces together when the adhesive is applied. Regardless of whether the position between both parts is critical to the design, the features design must be executed by first adding a reference feature that will position both parts in the XY plane, and then by adding the remaining features with a higher clearance in order to absorb any dimensional variation.

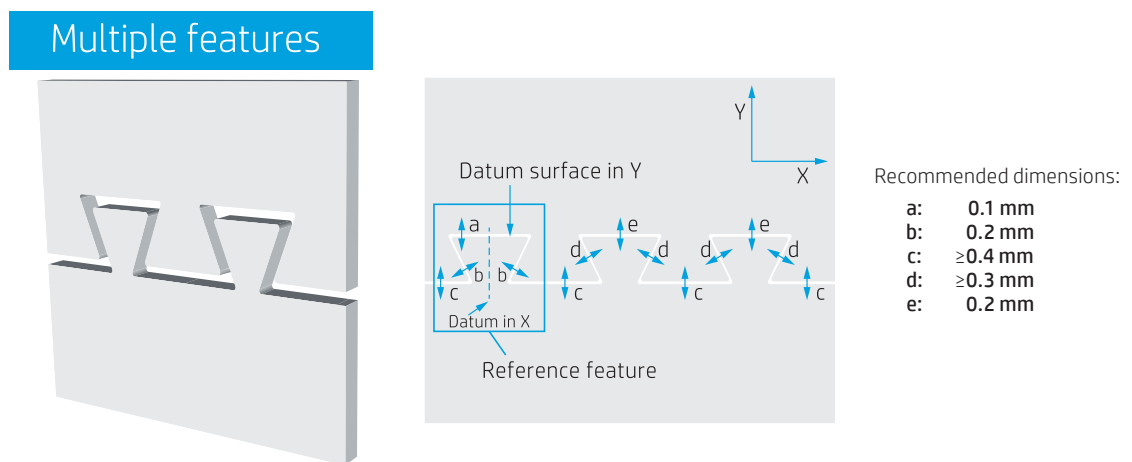

Figure 10: Multiple union features: Design recommendations

Combination of overlap joint with multiple jigsaw features

When taking into account all of the design recommendations mentioned above, the preferred union design is the combination of the overlap joint with reference features such as the jigsaw. Those reference features can be added to the non-visible surface and will help reference the two pieces between them to optimize the bonding performance.

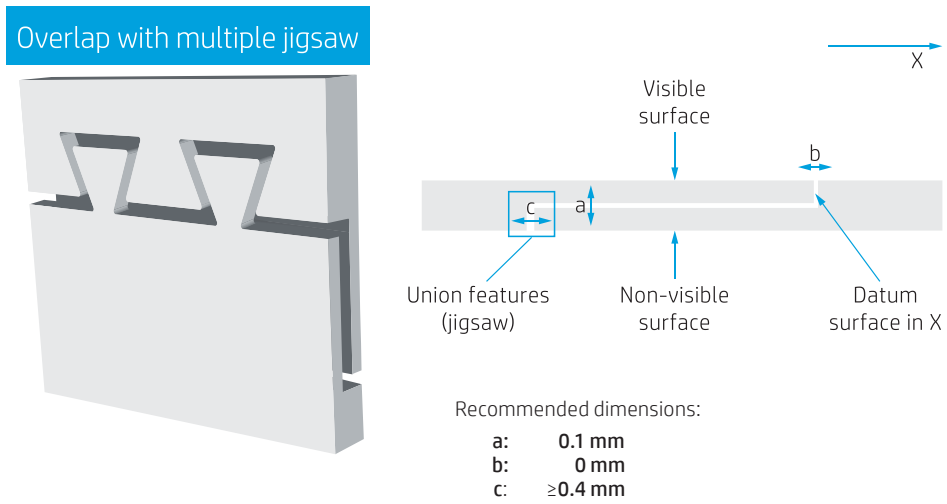

Figure 11: Overlap with multiple jigsaw features: Design recommendations

Additional options to increase bonding adhesion

When the adhesive material has the ability to fill gaps, the mechanical adhesion between the adhesive and the bonding parts can be improved by adding textures to their surfaces. This roughness improvement allows for mechanical interlocking by adding “teeth” to the surface and increases the total effective bonding area.

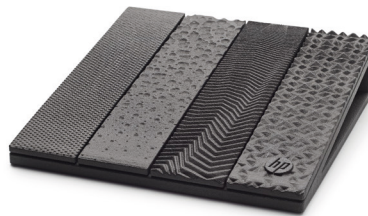

Figure 12: Example of texture to increase adhesion

An additional option to increase the bonding area is to include grooves to the bonding parts' surfaces.

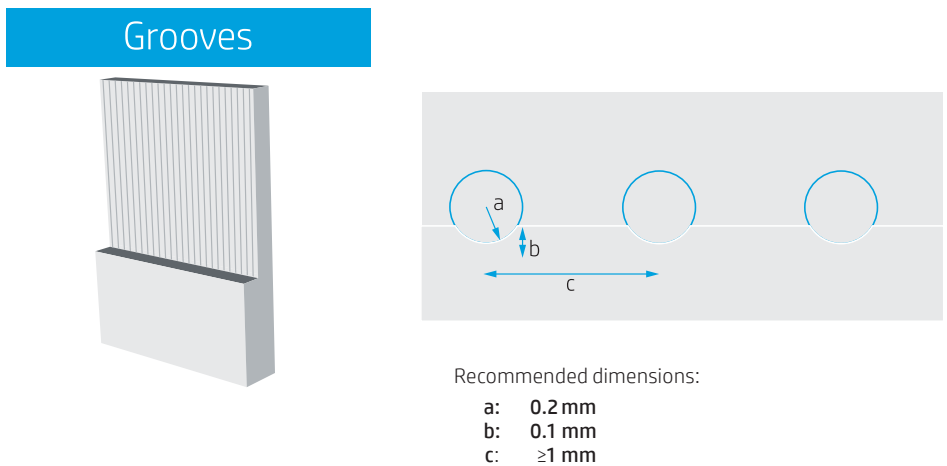

Figure 13: Grooves to increase bonding area: Design recommendations

Cutting recommendations

When a part needs to be cut, bear in mind which parts are the loads that will be applied to the final bonded assembly, as the bond robustness can be highly optimized depending on the design decisions.

The stress that appears in the bonding area depends on the applied loads. The most common are as follows:

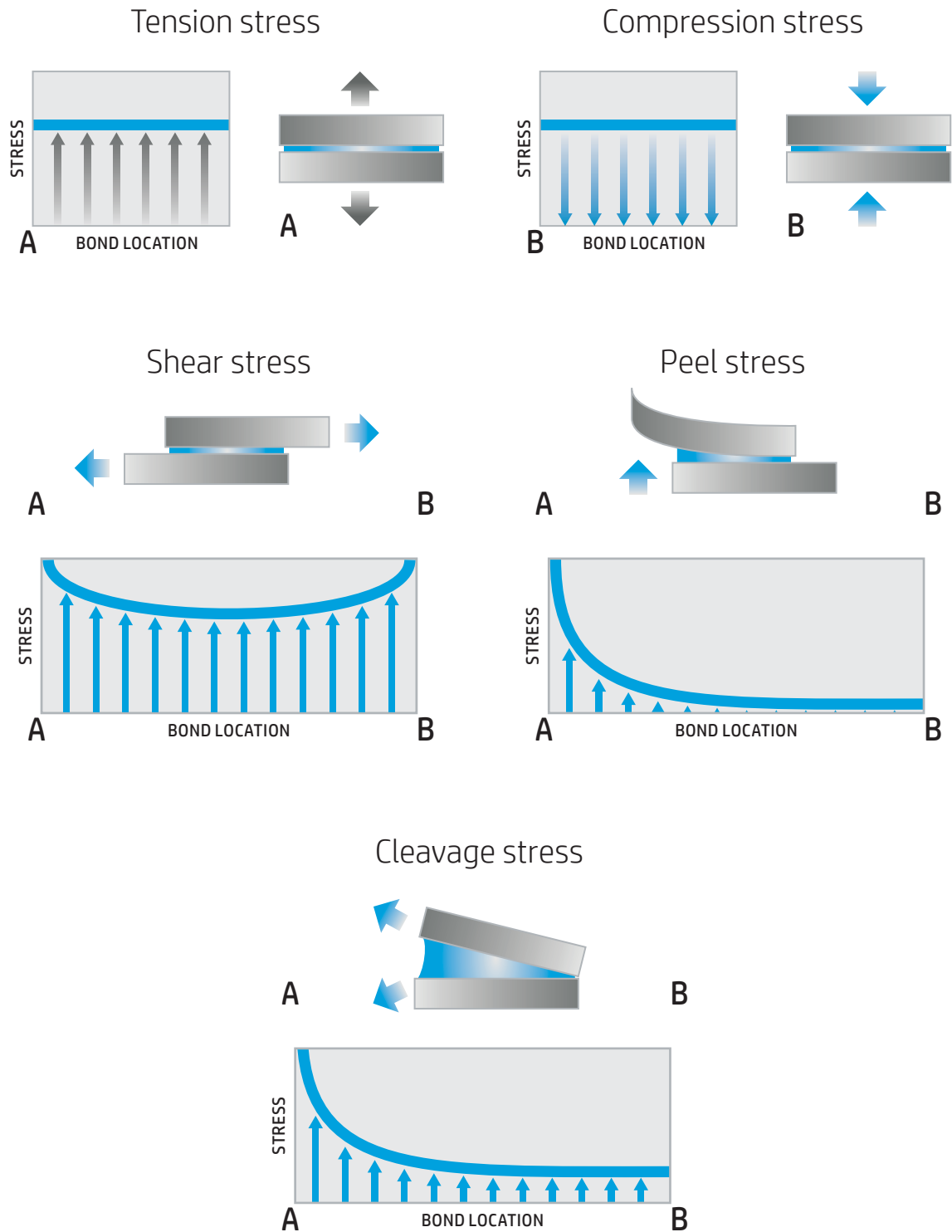

Figure 14: Stress distribution generated by different loads. Data courtesy of Henkel AG & Co. KgaA

When the cut is created, the design should be finished in order to prevent the development of peel, cleavage, or tension stress. The adhesive bondings work better under shear or compression stress, and the design should maximize the generation of those types of stresses to achieve a robust joint. The introduction of the overlap in the joint helps develop a bonding that works better under shear stress, which maximizes the performance of the union.



It is recommended to have a wider overlap area rather than a longer one. Having a wider overlap helps distribute more stress along the width and reduces the maximum values that appear on the sides.





Snap-fits

Design for HP MJF: Union joints design

Introduction

A snap-fit is an efficient assembly method used to attach plastic parts via a protruding feature on one part (e.g., a hook), which deflects during assembly to be inserted into a groove or a slot in the second part. After the assembly, the protruding feature returns to its initial position.

Snap-fits provide a simple and economical way to assemble plastic parts by drastically reducing assembly time. The way a snap-fit is designed determines whether it can be disassembled and reassembled several times and the force required to do so. This assembly method is suited to thermoplastic materials for their flexibility, high elongation, and ability to be printed into complex shapes.

HP Multi Jet Fusion technology allows for the designing and printing of parts with specific design features integrated, such as snap-fits, in order to connect them.

Types of snap-fits

The various types of snap-fits are listed below.

Cantilever snap-fit

The cantilever snap-fit is the most commonly used type of snap-fit. It consists of a cantilever beam with an overhang at the end. In this type of snap-fit there is a direct relationship between the robustness of the assembly and the strength of the snap-fit.

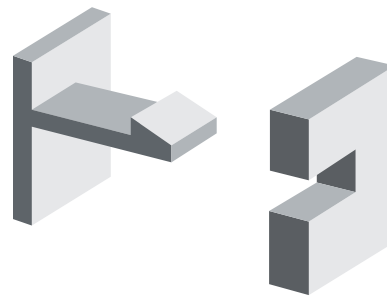

Figure 1. Cantilever snap-fit



Figure 2. Cantilever snap-fit assembly operation

L-shaped snap-fit

When it is not possible to design a cantilever snap-fit without compromising the robustness of the assembly and the strength of the snap-fit due to material or geometrical constraints, an L-shaped snap-fit can be an alternative. Adding a groove to the base of the snap-fit increases its flexibility while reducing the strain on the beam, compared with a cantilever snap-fit.



Figure 3. L-shaped snap-fit

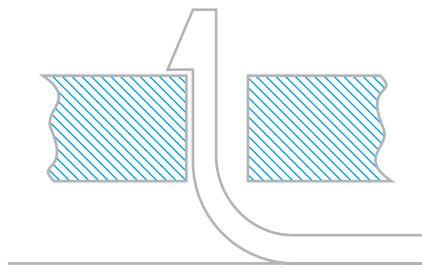

Figure 4. L-shaped snap-fit assembly operation

U-shaped snap-fit

The U-shaped snap-fit is another alternative to the cantilever snap-fit when it is necessary to increase the snap-fit flexibility within a reduced space. This U-shaped alternative is extremely flexible, and thus easier to remove. This type of snap-fit is usually used in cases where the parts need to be pulled apart repeatedly or when two parts don't require a lot of force to stay in position (e.g., in a battery compartment lid).

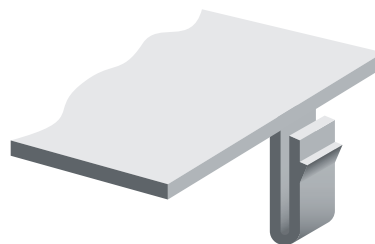

Figure 5. U-shaped snap-fit

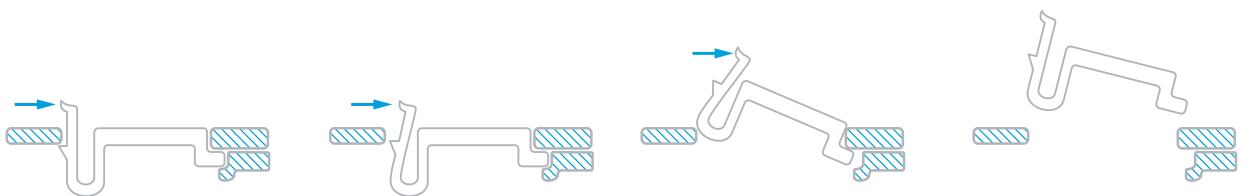

Figure 6. U-shaped snap-fit assembly operation

Annular snap-fit

The annular snap-fit is an assembly method usually used between two cylindrical or ring-shaped parts or between two rotationally symmetric parts, where the deformation required to assemble or disassemble the snap-fit is made in a 360° direction at the same time.

With this assembly method, one part is designed with an undercut and the other is designed with a mating lip. The joint occurs through the interference between both parts during the assembly operation.

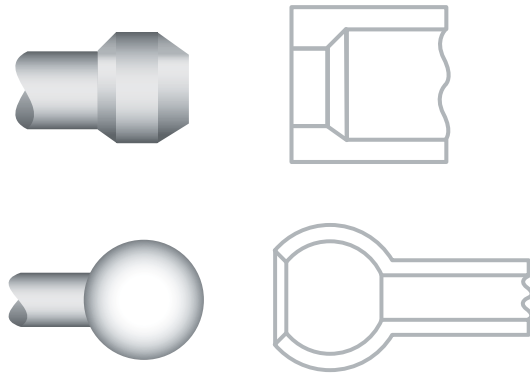

Figure 7. Annular snap-fit

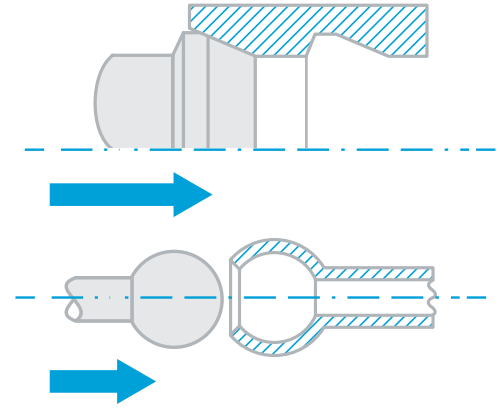

Figure 8. Annular snap-fit assembly operation

Torsional snap-fit

The torsional snap-fit is an assembly method where the flexible point is in a torsional bar instead of the self-snap-fit body. When the torsional bar is pushed down, it turns slightly and opens the joint.

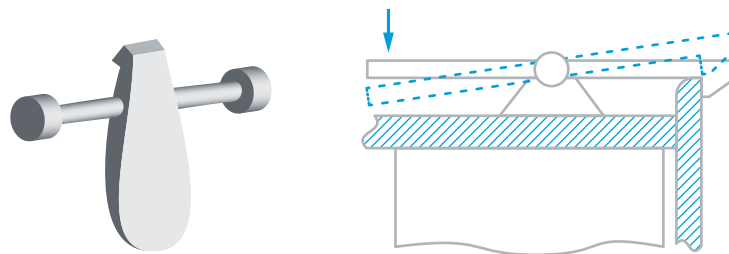

Figure 9. Torsional snap-fit

Design considerations

As mentioned previously, the most commonly used type of snap-fit is the cantilever snap-fit. When designing this type of snap-fit, it is important to design a balanced solution between the robustness of the assembly and the strength of the snap-fit cantilever beam.

This type of snap-fit can be approximated using a simplification of the general beam bending theory, which allows for the inspection of the snap-fit design feasibility. This approach models the cantilever snap-fit by a fixed-free beam with a point-applied end load:



Figure 10. Cantilever beam with a point-applied end load

Mating force and beam stress

The robustness of the assembly will be defined by the force (P) required to assemble and disassemble it. A weak force required to deflect the snap-fit beam will lead to a weak assembly that is unable to maintain the connection between both parts. Otherwise, a strong force will lead to an extremely robust assembly, which will be difficult to assemble and disassemble when required.

Moreover, the design of the snap-fit must be strong enough to resist the stress (σ) suffered by the beam when it deflects due to the mating force (P) applied, without compromising the snap-fit integrity and performance.

For this reason, the mating force (P) and the beam stress (σ) must be the main considerations when designing a cantilever snap-fit, and according to the beam bending theory, they are dependent upon the snap-fit geometry and the material used to make it.

Material and geometry dependence

Because of their direct relationship with the assembly robustness and snap-fit strength, the snap-fit material and geometry are considered the most critical design parameters, and they are often dependent upon the available design space.

For this reason, geometry and material choice are usually the first steps when designing a snap-fit.

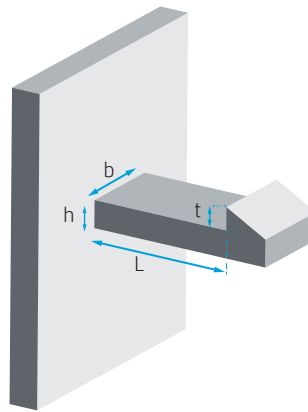

Figure 11. Snap-fit geometry

When choosing the snap-fit material and geometry (h , b , L , t), other dependent factors are clearly defined:

- Choosing the snap-fit cross-section geometry (h , b) allows the designer to calculate its moment of inertia (I), which, for a cantilever beam with a rectangular cross-section, is as follows:

$$I = \frac{b \cdot h^3}{12}$$

- Once the printing material is selected, the modulus of elasticity (E) is made clear since it is often provided in the material datasheet.



The product of the moment of inertia (I) and the modulus of elasticity (E) is known as the beam flexural rigidity (EI).

According to the beam bending theory, these dependent parameters, along with the snap-fit material and geometry, have a direct relationship with the required mating force (P) and the beam stress (σ), as shown below:

- Deflection (y) at the end of a cantilever beam with a point-applied end load:

$$y = \frac{P \cdot L^3}{3 \cdot E \cdot I} \quad (1)$$

- Maximum stress (σ) in a cantilever beam with a uniform rectangular cross-section:

$$\sigma = \frac{P \cdot L \cdot h}{2 \cdot I} \quad (2)$$

The minimum amount of deflection (y) at the end of the cantilever beam required to assemble and disassemble the snap-fit is usually a known parameter dependent upon the geometric constraints and the available design space. In fact, it is defined by the depth (t) of the snap-fit overhang:

- The minimum amount of deflection (y) must be at least equal to the depth (t) of the snap-fit overhang to allow a proper assembly and disassembly operation.

$$y \geq t$$

- A deeper overhang will lead to a strong assembly, but it will mean that the beam must deflect further and, as a consequence, it will require a greater mating force (P)—as shown in equation (1)—and the beam stress (σ) will also increase—as shown in equation (2).

Design calculations

The first step in checking the snap-fit design feasibility is to calculate the resultant mating force (P) and to check whether it is suitable. This calculation can be done by solving the equation (1) for P :

$$P = \frac{3 \cdot E \cdot I \cdot y}{L^3} \quad (3)$$

Based on the equation (3), the force (P) is dependent upon how much farther the snap-fit beam must deflect (y), but it also will depend on the material resistance against the bending deformation, which is known as beam bending stiffness (k), and its function of the beam flexural rigidity (EI), the length (L) of the beam, and beam boundary condition:

$$P = k \cdot y \quad (4)$$



The suitable mating force (P) value should not be greater than 50N to 100N, which is considered an ergonomic value for an estimated finger strength average.

Once the mating force (P) has been calculated and it results in a suitable value, the second step to check the snap-fit feasibility is to calculate the stress (σ) in the cantilever beam based on the equation (2).

If the beam stress (σ) is above the yield strength of the material, the snap-fit will deform, and some part of the deformation will be permanent and non-reversible, thus compromising the snap-fit performance and strength up to rupture.

$$\text{Beam stress } (\sigma) < \text{Material yield strength} \quad (5)$$

Considering that the yield strength is not a common property specified in technical datasheets when producing plastic parts, the best option to calculate the snap-fit strength is to use the material allowable strain (ϵ) and modulus of elasticity (E):

$$\text{Beam stress } (\sigma) < E \cdot \epsilon \quad (6)$$

In order to obtain the allowable strain (ϵ) value, designers can refer to usual recommendations for other plastic manufacturing processes such as Injection Molding:

$$\text{Allowable strain } (\epsilon) < \frac{1}{3} \cdot \text{Material elongation at yield} \quad (7)$$

All design considerations are shown in the following flowchart:

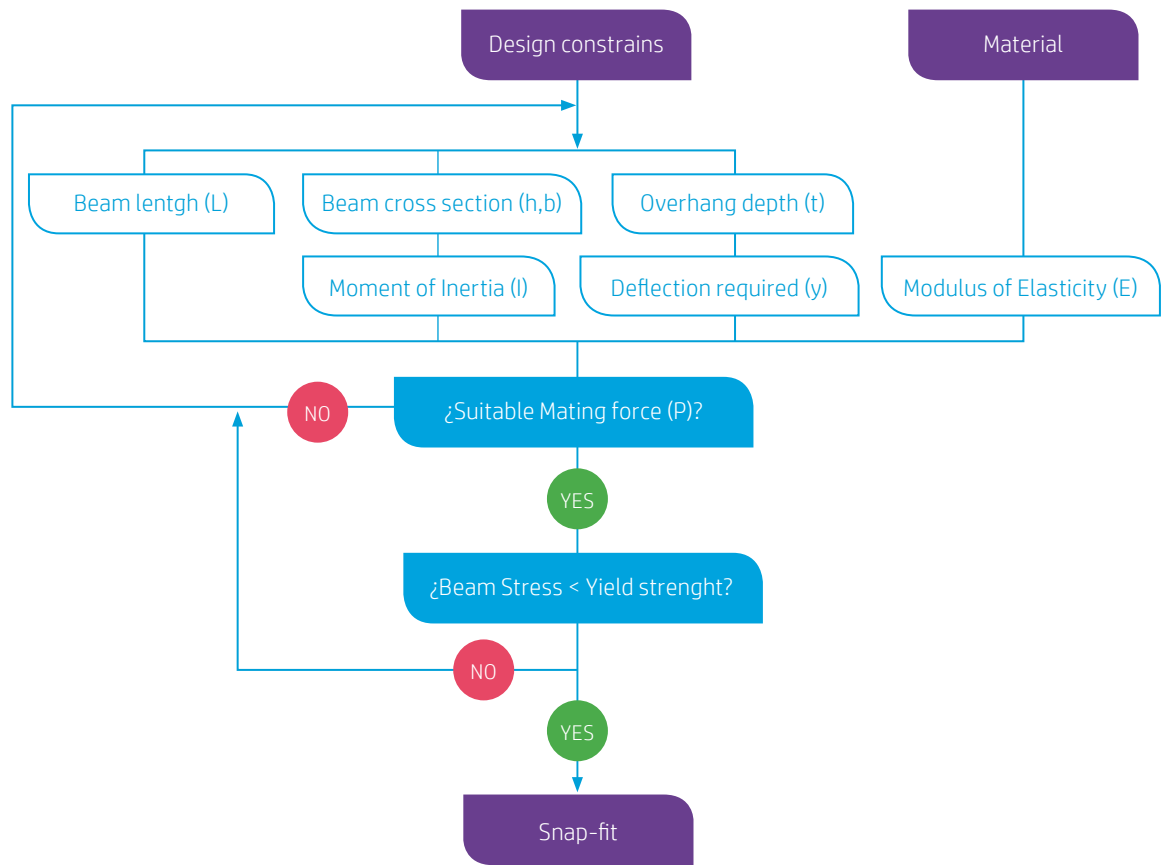

Figure 12. Design snap-fit flowchart

	(Permissible) deflection			Deflection force
Type of design				
Shape of the cross section				
	$y = 0.67 \cdot \frac{\epsilon \cdot L^2}{h}$	$y = 1.09 \cdot \frac{\epsilon \cdot L^2}{h}$	$y = 0.86 \cdot \frac{\epsilon \cdot L^2}{h}$	$P = \frac{bh^2}{6} \cdot \frac{E \epsilon}{L}$

Figure 13. Snap-fit calculation equations*

*Note 1: Beam deflection (y) expressed in terms of allowable strain (ε), based on equations (1), (2)
 *Note 2: Mating or deflection force (P) expressed in terms of allowable strain (ε), based on equation (2)

Design guidelines

There are several design recommendations when designing snap-fits with HP Multi Jet Fusion:

Minimum thickness (h)

The minimum recommended thickness at the base of the cantilever is 1 mm.

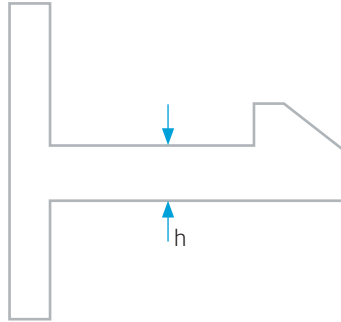

Figure 14. Minimum thickness at the base of the cantilever

Minimum overhang depth (t)

The minimum overhang depth (t) should be at least 1 mm.

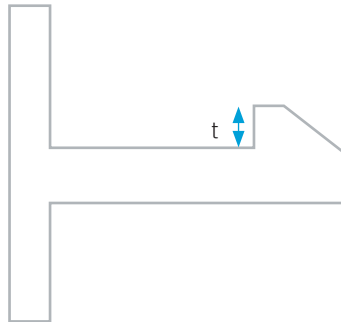

Figure 15. Minimum overhang depth (t)

Recommended common radius

It is recommended to add a common radius at the base of the cantilever to avoid sharp corners and reduce the stress concentration. This common radius should be at least half of the thickness (h) of the base of the cantilever.

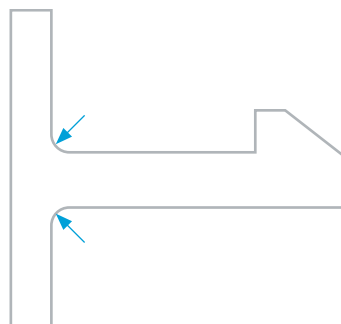

Figure 16. Common radius

Snap-fit overhang

It is recommended to avoid sharp edges at the end of the snap-fit overhang, adding a small chamfer to prevent breaking during the assembly operation.

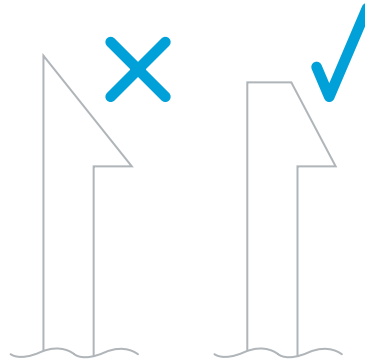

Figure 17. Snap-fit overhang

Assembly angle (α)

As mentioned previously, the snap-fit overhang usually has a gentle chamfer to facilitate the assembly operation. The inclination of this chamfer angle (α) directly affects the mating force (P). If the angle (α) is reduced, the mating force (P) will also reduce. The recommended assembly angle value should be between 35° and 40° .

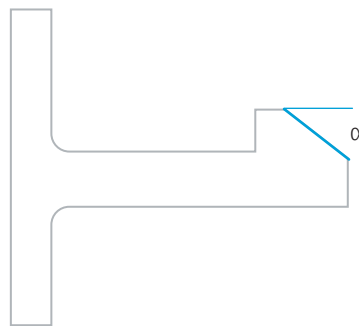

Figure 18. Assembly angle

Disassembly angle (β)

The way the overhang is designed determines whether the snap-fit can be disassembled and reassembled several times. The disassembly angle (β) affects the ease of joint disassembly. For example, a 90° angle (β) can never be disassembled. However, a snap-fit with a disassembly angle (β) equal to the assembly angle (α) will need the same mating force (P) for both operations.

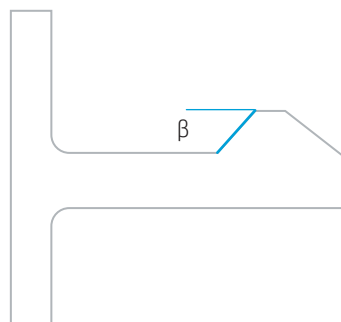

Figure 19. Disassembly angle

Tolerances between parts

When designing a snap-fit, there must be a gap between the protruding feature and the groove to ensure a proper performance, even including the worst tolerance case as shown in the following figure:

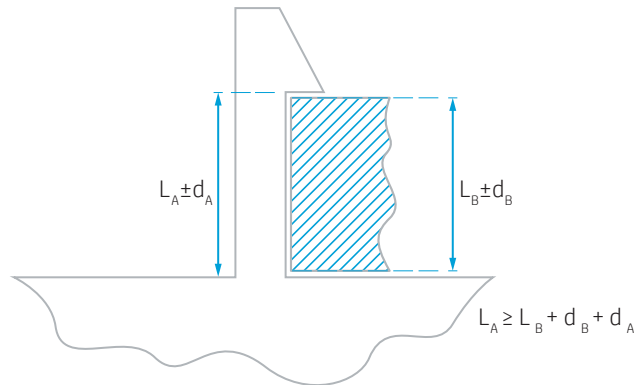

Figure 20. Tolerances between parts

Modifying the mating force (P)

Sometimes, after choosing the snap-fit material and geometry, the resulting mating force (P) is a non-desirable value. Based on the equation (3) and bearing in mind that when designing a snap-fit, the most common restrictive tolerances are the length (L) of the beam and the depth (t) of the overhang, the most common solution when modifying the mating force (P) is needed is to change the cantilever cross-section (h, b).



Reducing the mating force (P) will also reduce the beam stress (σ).

Tapered beam

One of the most recommended changes in the snap-fit cross-section is to design a tapered beam. While a snap-fit beam with a uniform cross-section has an uneven distribution of strain and concentrates the stress at its base, a tapered beam uses less material and results in a more even distribution of strain throughout the cantilever, thus reducing stress (σ) concentration and the assembly and disassembly force (P).

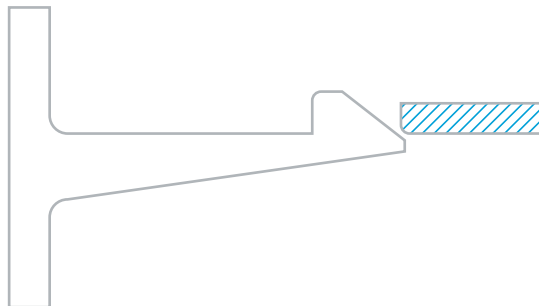

Figure 21. Tapered beam

Printing orientation

There are some recommended orientations when printing a snap-fit regarding its accuracy and proper performance.

For tight snap-fits

When printing tight snap-fits where the length of the beam (L) is critical, the XY plane orientation is recommended to achieve the best accuracy and, thus, a better performance.

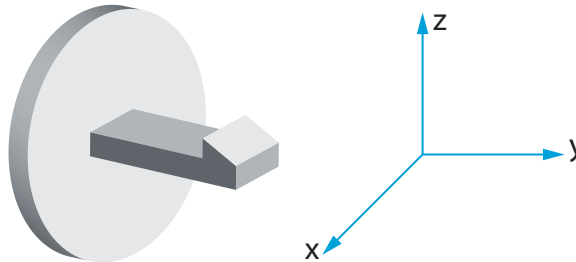

Figure 22. XY plane orientation

When the width of the snap-fit (b) is critical, the XZ or YZ plane orientation is recommended to achieve the best accuracy and to avoid excessive clearances on the XY plane, which can lead to noise and vibrations.

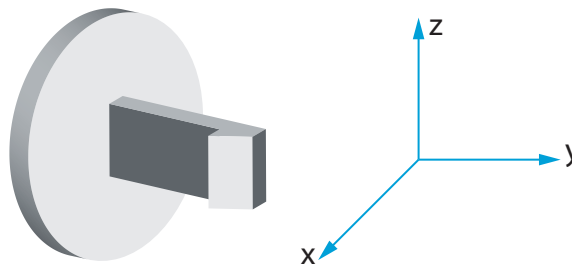

Figure 23. XZ or YZ plane orientation

To reduce printing issues

Printing the snap-fit inclined slightly in the X, Y, and Z axes can reduce the likelihood of typical printing issues.

Post-processing recommendations

HP MJF technology allows for different post-processing methods that can affect the finishing of the printed part. Although most of the post-processing methods should not affect a 3D printed snap-fit, there can be some automatic post-processes that affect it, such as the tumbler post-process.

The tumbler post-process involves hitting the 3D printed part with small abrasive pellets in order to reduce its roughness. In return, some dimensions and/or small features can be affected by the process.

In the case of the snap-fits, a tumbler process can reduce the mating force (P) of the assembly and even break it depending on the snap-fit geometry.

For this reason, if automatic post-processes are required, it is recommended to protect the part with a sinter box to prevent damage.

Calculation example

The following figure illustrates the calculation needed when designing a cantilever snap-fit.

In this particular case, a clipping system for an optical sensor must be designed as follows:

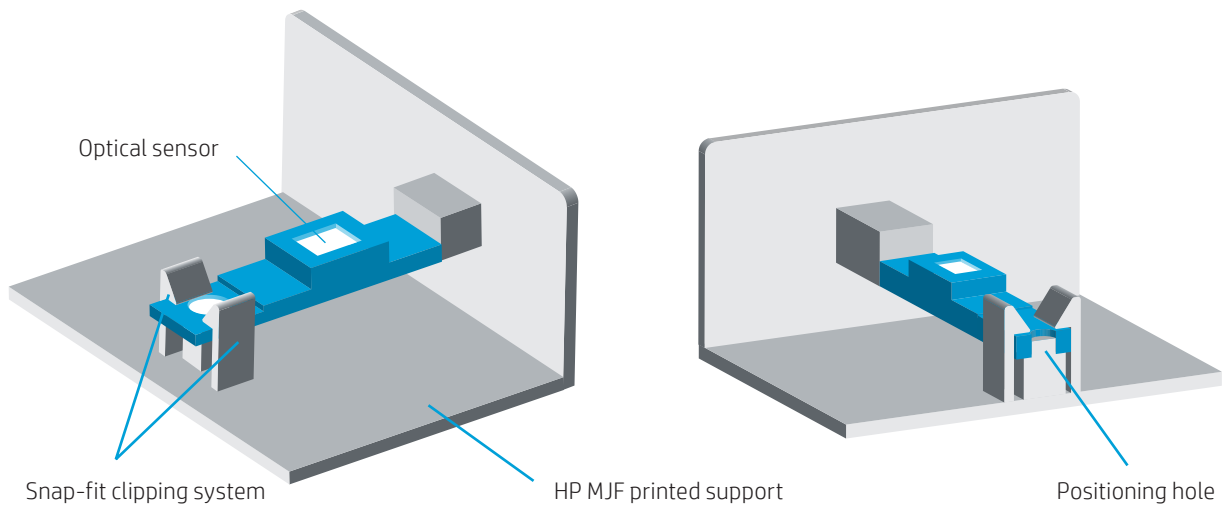

Figure 24. Optical sensor clipping system

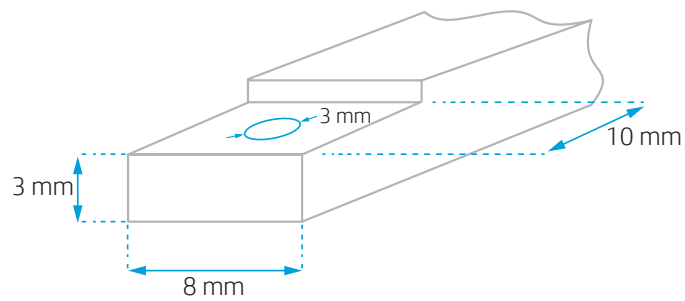

Figure 25. Optical sensor dimensions

The design requirements are listed below:

- The material used to print the part is HP 3D HR PA 12, with an elastic modulus of elasticity (E) of 1800 MPa.
- Due to optical requirements, the sensor must lay 5 mm above the base. Thus, the snap-fit total length must consider the worst-case tolerances and the optical requirements:

$$L = 3 \text{ mm} + 0.1 \text{ mm} + 5 \text{ mm} + 0.2 \text{ mm} + 0.2 \text{ mm} = 8.5 \text{ mm}$$

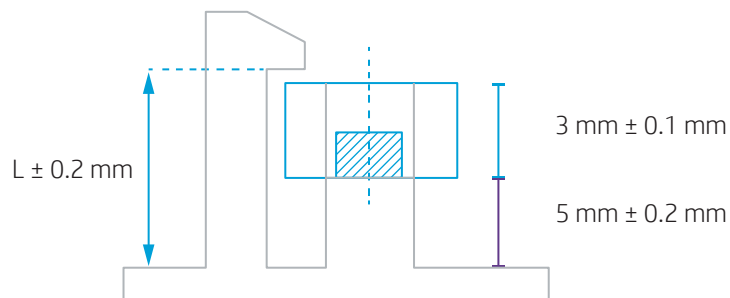

Figure 26. Snap-fit length calculation

- Due to constructive constraints, the snap-fit cannot overlap the positioning hole, which means that the overhang depth (t) must be between 1 mm—the minimum recommended value—and 2.5 mm—the maximum allowable distance to avoid contact between the snap-fit overhang and the sensor positioning hole:

$$\text{Overhang depth } (t) = y = 1 \text{ mm}$$

- The width must be smaller than 10 mm due to geometrical constraints:

$$b = 9.5 \text{ mm}$$

Once the snap-fit material and geometry (h, b, L, t) are clearly defined, the resulting mating force (P) must be calculated to check whether it is suitable. This calculation can be done using the equation (3):

$$P = \frac{3 \cdot E \cdot I \cdot y}{L^3} = \frac{3 \cdot E \cdot (b \cdot h^3) \cdot y}{12 \cdot L^3} = \frac{3 \cdot 1800 \text{ MPa} \cdot 9.5 \text{ mm} \cdot (1.5 \text{ mm})^3 \cdot 1 \text{ mm}}{12 \cdot (8.5 \text{ mm})^3} = 23.49 \text{ N}$$

The calculated mating force (P) value is inside the ergonomic range. Therefore, based on the equation (2) and (6), the next step is to check the strength of the snap-fit calculating the allowable strain (ϵ):

$$\sigma = \frac{P \cdot L \cdot h}{2 \cdot I} = E \cdot \epsilon$$

$$\epsilon = \frac{P \cdot L \cdot h}{2 \cdot I \cdot E} = \frac{12 \cdot P \cdot L \cdot h}{2 \cdot (b \cdot h^3) \cdot E} = \frac{12 \cdot P \cdot L}{2 \cdot (b \cdot h^2) \cdot E} = \frac{12 \cdot 23.49 \text{ N} \cdot 8.5 \text{ mm}}{2 \cdot (9.5 \text{ mm} \cdot (1.5 \text{ mm})^2) \cdot 1800 \text{ MPa}} = 0.03 = 3\%$$

The calculated allowable strain (ϵ) shows that the snap-fit does not deform when it deflects due to the mating force (P) applied, without compromising its integrity and performance.





Recommended formats and resolutions

Design for HP MJF

Introduction

Before sending a job to print, the 3D model must be converted into a file extension that HP Jet Fusion 3D Printing Solutions are able to interpret.

The most commonly used file extension in 3D printing is STL, despite the fact that it lacks even basic 3D model information such as color or the identification of distance units.

For this reason, HP and other 3D printing leaders have identified the need to develop a file extension that supports the needs of current 3D printing applications, services, and devices. A 3MF consortium has been formed to deliver a format—3MF—that meets the needs of the 3D printing industry with the possibility to grow as the industry evolves.

Moreover, a 3MF extension file will have a much lower weight compared with an STL file for a specific 3D model and resolution.

Tessellation

To convert a 3D model into a 3D printing file, it is necessary to tessellate the model, which means converting its geometry into linked triangles to convey its surface.

Once the 3D model has been tessellated, it is imported into slicer software, which slices the 3D model into layers and prepares it to be sent to the printer. It is very important to pay attention to this step: If it is not done correctly, it can cause problems such as geometric inaccuracies or slow processing.

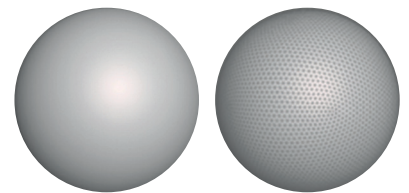

Figure 1. Example of tessellation

A normal file size for a 3D model is between 1 and 30 MB, but the size depends on the type of software that created it, the number of triangles, and the amount and level of details (e.g., a higher resolution means in a higher number of triangles, which will result in a heavier file size).

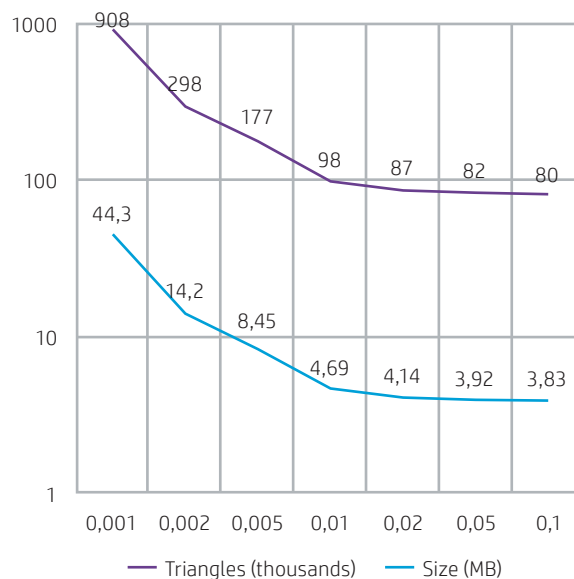

Figure 2. Triangle counts and file sizes vs. exported accuracy

Exporting a model from CAD

Although each version of CAD software uses a different method to export a 3D model to an STL or 3MF file, it is often necessary to manually enter some exporting parameters such as deviation chord height and angle tolerance, which define the resolution and the size of the STL or 3MF file by altering the tolerance in CAD software.

Deviation chord height

The deviation chord height is the maximum distance between the geometry of the 3D model and the surface of the STL or 3MF file. The recommended value for the chord height is 0.05 mm. A smaller deviation chord height will result in a more accurate surface.

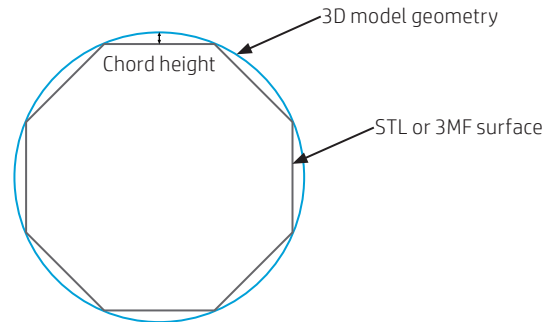

Figure 3. Deviation chord height

Angle tolerance

The angle tolerance is the maximum angle between the normal vectors of adjacent triangles. The recommended value for the angle tolerance is 1° .

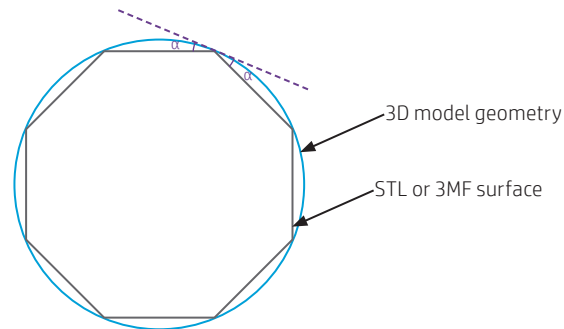

Figure 4. Angle tolerance

Exporting errors

Unexpected results such as surface inaccuracy (e.g., unexpected holes, unjoined triangles, overlapped triangles, tiny shells, flipped-direction triangles) or poor resolution are common errors that may occur when an STL or 3MF file is inadequately exported.

Too many or too few triangles

Although a mesh with more triangles tends to be more accurate, too many triangles are difficult to process and, when a certain size is reached, the additional triangles do not provide enhanced accuracy. For this reason, an excess number of triangles could increase processing time with no benefit.

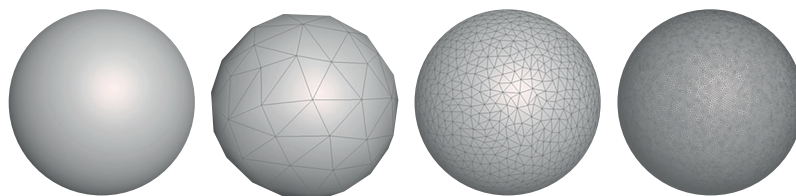

Figure 5. Examples of tessellation (from left to right): 3D model, tessellation with too few triangles, correct tessellation, tessellation with too many triangles

Similarly, too few triangles can lead to poor resolution results. Triangulation of a surface causes faceting of the 3D model. The exporting parameters used to output an STL or 3MF file affect how much faceting occurs.

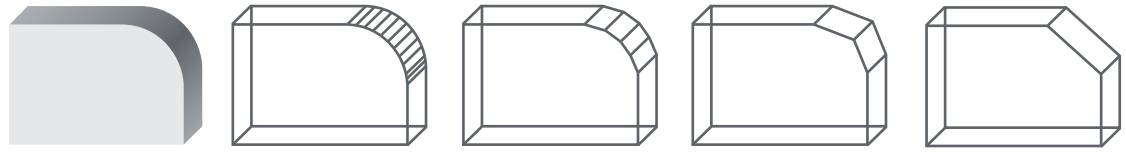

Figure 6. Exporting quality is dependent upon 3D model design



A small mesh doesn't necessarily mean lower quality. Rectilinear surfaces result in very high quality with a very small number of triangles. The necessary exporting quality is very design-dependent.

Repairing STL files

Common errors can normally be fixed by properly designing and exporting the 3D model using CAD software or another appropriate repair software. The most common software for repairing STL or 3MF files are the following:

- Materialise Magics with Materialise Build Processor
- Autodesk® Netfabb® Engine
- HP SmartStream 3D Build Manager

Dimensions in printer resolution

The minimum controllable printable volume when printing with HP Multi Jet Fusion technology is known as a voxel, which defines the resolution.

The HP Multi Jet Fusion voxel resolution in the Z axis is 80 microns. Thus, it is important to align critical dimensions to an integral number of voxels: It is possible to obtain a 3D printed block of 160 microns or 240 microns, but it is not possible to obtain one with 168.5 microns.

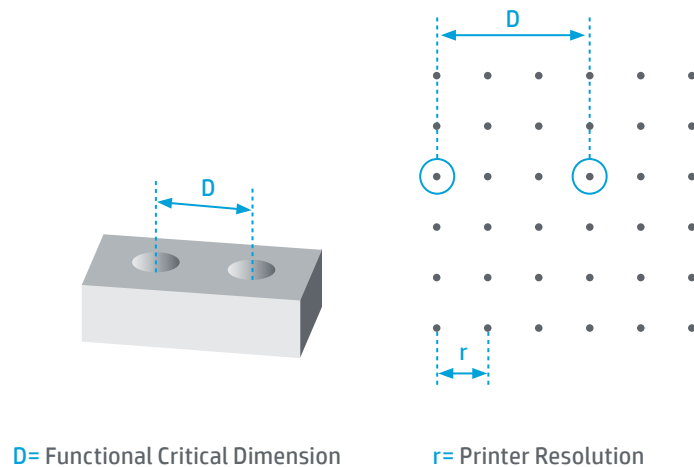

Figure 7. Printer resolution

©Copyright 2019 HP Development Company, L.P. The information contained herein is subject to change without notice.

The information contained herein is provided for information purposes only. The only terms and conditions governing the sale of HP 3D printer solutions are those set forth in a written sales agreement. The only warranties for HP products and services are set forth in the express warranty statements accompanying such products and services. Nothing herein should be construed as constituting an additional warranty or additional binding terms and conditions. HP shall not be liable for technical or editorial errors or omissions contained herein and the information herein is subject to change without notice.



General recommendations for printing processes

Tuning your HP MJF to the design



Introduction

When using HP Multi Jet Fusion (MJF) technology, there are general recommendations to follow to optimize the printing process, keep the printer in top condition, and obtain the desired results.

General considerations

General considerations to keep in mind are as follows:

Equipment

- The operating temperature of the equipment should be between 20°C and 30°C to prevent thermal fluctuations. Going beyond these limits could have adverse effects on part quality.
- The printer's operating relative humidity (RH) should be between 30% and 70% for optimal system usage and performance. Depending on the material, a different operating relative humidity might be necessary for processing. For example, HP 3D HR PA 12 requires relative humidity levels between 50% and 70%. To verify specified environmental conditions, check the material data sheet.
- Power line quality is important. If it is suspected that the power installation at the site will suffer from variability or alterations, it is recommended to install an uninterrupted power supply (UPS) system.
- The set-up altitude should be based on the location of the facility and the printer. A wrong selection could directly affect the cooling system and pressure parameters.
- Read the User Guide to master the key aspects related to cleaning, maintenance, and calibration practices.
- Make sure that the glasses that cover both fusing lamps and the thermal camera are clean.
- Ensure that the printer's thermal control is properly calibrated and meets the following parameters:
 - Temperature camera calibration:* This calibration is used to compensate for small misplacements of the top temperature camera sensor. This calibration is only needed for new installations and after thermal camera replacements.
 - Fusing lamps calibration:* This calibration is used to correct irradiance deviations and obtain the true statuses of the lamps. It is highly recommended to perform this calibration under 40% to 60% relative humidity and to double check the printer's RH readings with an external humidity sensor. This calibration is only needed after a fusing lamp replacement or intensive cleaning of burn spots.
- Some problems may be caused by printhead issues, so it is important to make sure that the printheads are correctly maintained and aligned, and that nozzles are in good condition.
- Even if the printer is perfectly clean and calibrated, it may be necessary to fine-tune the energy provided by the lamps. To do this, the operator can modify the irradiance of the lamps depending on an assessment after printing some control parts. Each print profile requires a specified fusing lamp irradiance. The fusing lamp irradiance value can be checked on the front panel before printing.

Printing profiles and materials

HP Multi Jet Fusion technology allows for the use of different powdered materials, such as HP 3D HR PA 11 ("HP PA 11"), HP 3D HR PA 12 ("HP PA 12"), and HP 3D HR PA 12 Glass Beads ("HP PA 12 GB").

Some materials like HP PA 11 and HP PA 12 can be printed using different print profiles, which are tested sets of parameters aimed toward maximizing specific final properties such as dimensional accuracy, mechanical strength, or part appearance.

There is a relationship—maintained across different current materials—between the energy received by the parts during the printing process and the general consequence of their mechanical properties and appearance, as shown in Figure 1:

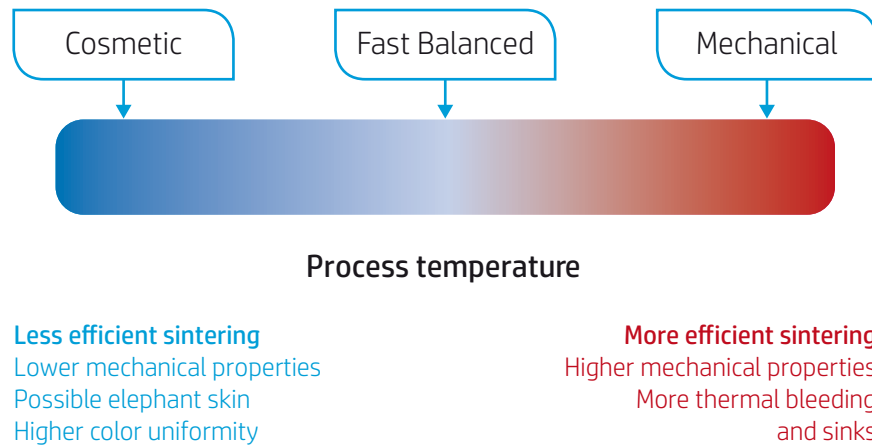

Figure 1. Relationship between process temperature and main part attributes

Thus, the hotter the part, the greater the sintering of the powder, leading to denser parts with stronger properties. However, excessive heat can result in adjacent powder sticking to the surface of the parts (thermal bleeding) and contraction-related artifacts such as sinks.

On the colder side of the spectrum, these effects are minimized, thus improving the overall look of the parts at the expense of mechanical performance and localized non-homogeneous shrinkage.

Print profiles are placed on the scale as a guideline, but their exact position would be determined by their fine-tuning potentiality. Fine-tuning is required to center these print profiles at the optimum levels according to the specific application.

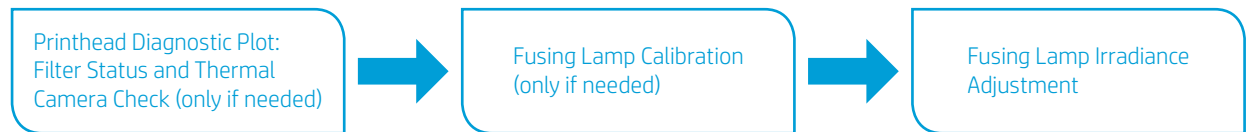

Figure 2. Fine-tuning process

- Extremely high-packing density jobs, non-recommended powder mix ratios, and poor system maintenance may lead to some part quality issues.
- It is recommended to use balanced print profiles (HP PA 11, HP PA 12, and HP PA 12 GB), which require two passes per layer, for a compromise between look and feel, dimensional accuracy, and mechanical properties. The compromise in dimensional accuracy in HP PA 11 occurs mainly in the Z-direction with respect to HP PA 12.

Balanced print profiles result in greater elongation and impact resistance for HP PA 11 compared with HP PA 12, while HP PA 12 GB provides a higher modulus with lower elongation.

HP PA 12 GB has a single print mode without a specific name, but it must be considered as balanced.



- It is recommended to use mechanical print profiles (HP PA 11 and HP PA 12), which also require two passes per layer, to achieve the best elongation at breakpoints and impact resistance results while maintaining tensile strength, which is not affected with respect to balanced print profiles.



Fast print profiles result in greater elongation and impact resistance for HP PA 11 compared with HP PA 12.

- Fast print profiles (HP PA 11 and HP PA 12) are recommended for reducing time and cost as they use half the number of printing passes as Balanced or Mechanical modes and require a lower volume of fluid agents. In both cases, tensile strength remains comparable to their respective Balanced modes but elongation at breakpoints is lowered, especially in the Z-direction. This trade-off is less pronounced for HP PA 11 than for HP PA 12, since the overall mechanical performance is higher for all HP PA 11 print profiles. Furthermore, the Fast print profile for HP PA 11 generally yields linear accuracy comparable to that of Balanced HP PA 11 but shows reduced warpage.
- The cosmetic print profile is only available for HP PA 12 and aims to reduce the occurrence of geometric artifacts such as sinks on the tops of parts. It requires two passes per layer.

To highlight the differences between the current print profiles and materials, the behavior of their general characteristics is approximated, as shown in Figure 3:

HP PA 12 Balanced print mode

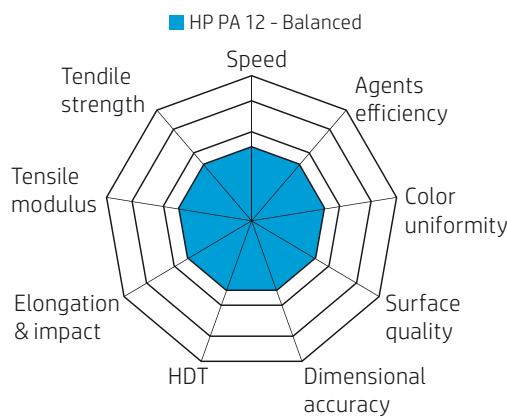

HP PA 12 Mechanical print mode

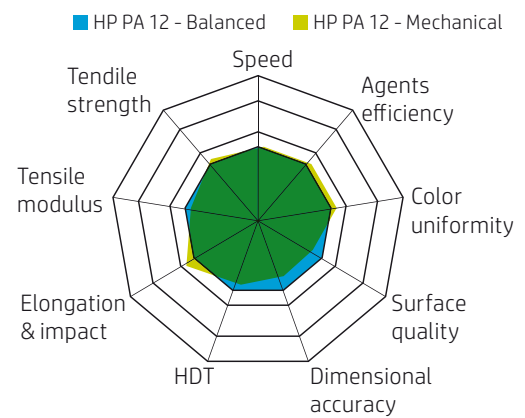

HP PA 12 Fast print mode

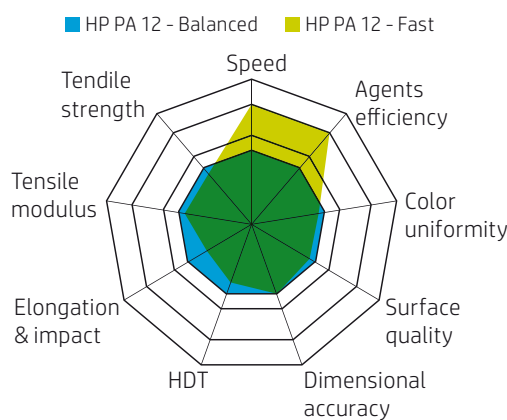

HP PA 12 Cosmetic print mode

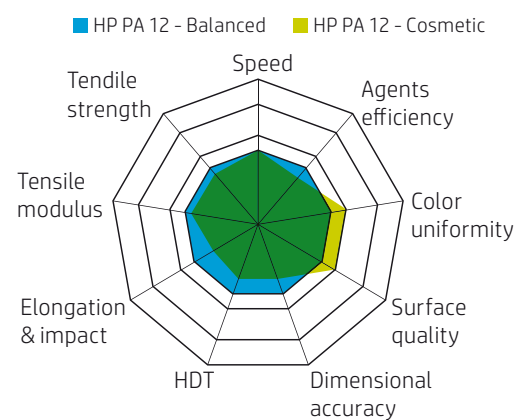

HP PA 11 Balanced print mode

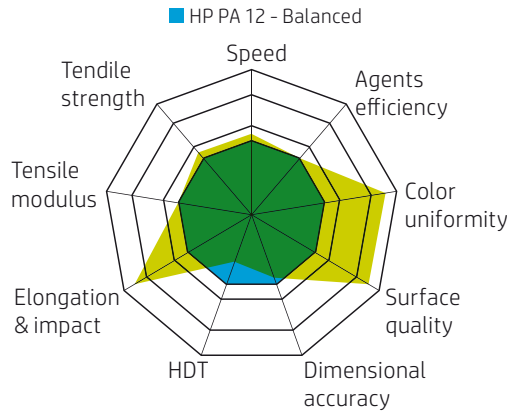

HP PA 11 Mechanical print mode

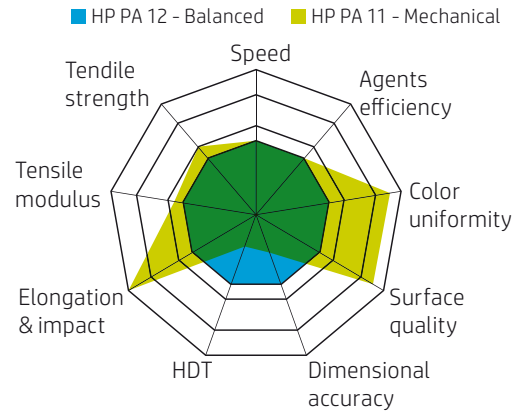

HP PA 11 Fast print mode

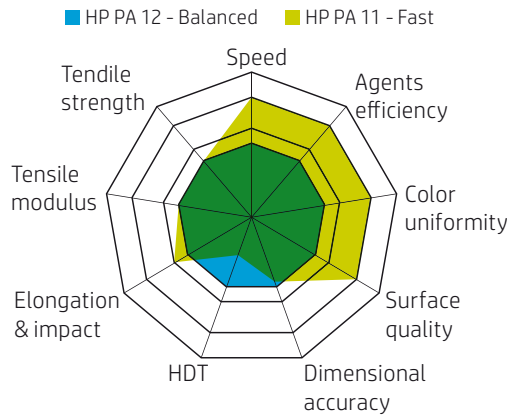

HP PA 12 GB print mode

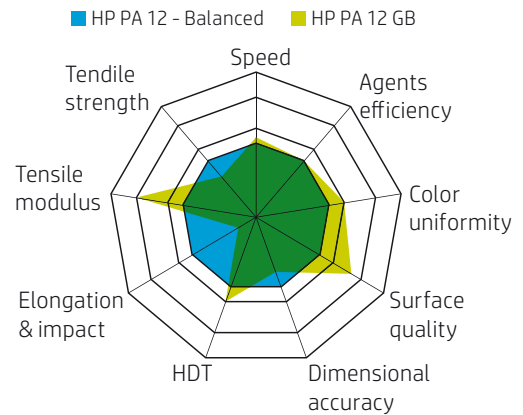

Figure 3. Comparison of the general characteristics of the available print profiles for HP 3D HR PA 11, HP 3D HR PA 12, and HP 3D HR PA 12 GB. Speed refers to the total printing time of a full bucket. Agents efficiency represents the amount of fluid agents used per bucket, with higher values meaning lower consumption. Color Uniformity and Surface Quality are based on representative parts evaluated for known artifacts (e.g., stair-stepping, thermal bleeding, etc.). Dimensional Accuracy refers to the deviation of printed parts with respect to their digital files, combining linear accuracy and shrinkage-related effects. Heat Deflection Temperature (HDT) at 1.82 MPa. Elongation at breakpoints & Impact, Tensile Modulus, and Tensile strength are measured according to international standards

For more information, please visit
hp.com/go/3DMaterials

©Copyright 2019 HP Development Company, L.P. The information contained herein is subject to change without notice.

The information contained herein is provided for information purposes only. The only terms and conditions governing the sale of HP 3D printer solutions are those set forth in a written sales agreement. The only warranties for HP products and services are set forth in the express warranty statements accompanying such products and services. Nothing herein should be construed as constituting an additional warranty or additional binding terms and conditions. HP shall not be liable for technical or editorial errors or omissions contained herein and the information herein is subject to change without notice.





Process for Accuracy

Tuning your HP MJF to the design

Introduction

There are several recommendations that must be evaluated during the printing process to maximize accuracy.

Optimizing dimensional accuracy

To maximize accuracy, the system needs to operate at voxel level with adequate energy delivered to properly fuse the intended sections layer by layer. To achieve this, it is recommended to bear the following in mind:

Printing profiles and materials

- In general, Balanced print profiles are recommended for optimizing dimensional accuracy. Fast modes (HP 3D HR PA 11 ["HP PA 11"] and HP 3D HR PA 12 ["HP PA 12"]) can be considered lower-cost alternatives, keeping in mind their associated mechanical trade-off.
- In the case of HP PA 11, it is also better to use the Balanced print profile, which is dimensionally similar to HP PA 12 on the XY-plane but has a higher trade-off with respect to the Z-axis.
- When warpage is the main concern, it is recommended to switch from Balanced (HP PA 11) to Fast (HP PA 11).
- With thin and long parts where flatness is critical, consider using HP PA 12 or HP 3D HR PA 12 Glass Beads ("HP PA 12 GB"), since HP PA 11 presents higher warpage potential. If HP PA 11 is the material of choice, then it is recommended to use the Fast print profile.

Build platform placement and printing process

- Orient each part by placing its critical features on the horizontal XY-plane as this will provide the highest resolution.
- Place small features such as pins, holes, and thin walls upside-down on the XY-plane to improve their look, feel, and strength. This also applies to raised texts, which should be printed on the XY-plane for maximum resolution.
- Embossed text, however, results in increased clarity when printed facing upwards.



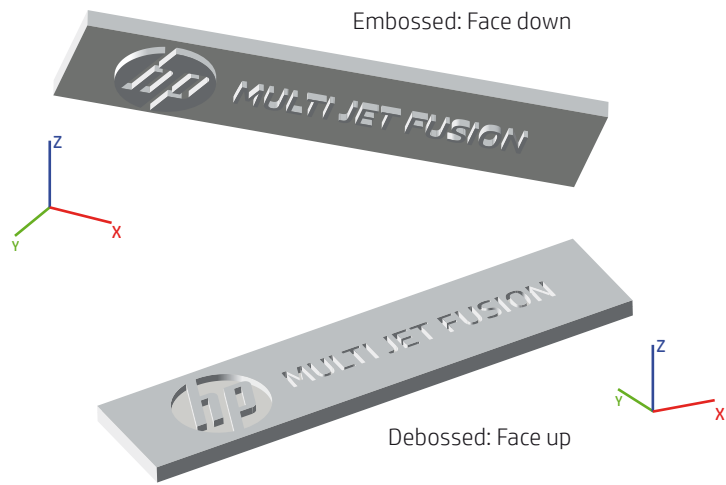

Figure 1. Recommended orientations for embossed (face down) and debossed (face up) text on HP Multi Jet Fusion parts

- The recommended minimum distance between parts is 5 mm, and the ideal distance between parts and the build volume margins is between 10 mm and 20 mm.
- It is recommended to leave enough space between dense parts, or those with a wall thickness greater than 15 mm. This distance should be more than 10 mm.

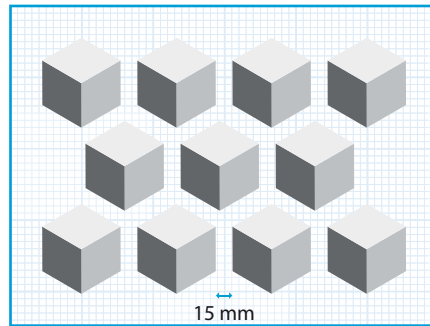

Figure 2. Recommended distance between dense parts

- It is recommended to place the parts with the highest dimensional requirements, especially on the Z-axis, as centered and as low on the printing platform as possible.
- It is recommended to distribute the parts as homogeneously as possible on the XY-plane to facilitate similar energy absorption across the printing bed.

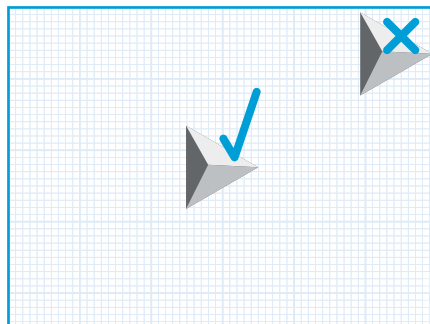

Figure 3. Recommended parts placement

- As well as in the XY-plane, it is recommended to place the parts in the bucket to prevent drastic changes in the printed areas per layer in the Z-direction.



Information about the printed area distribution is provided by some professional suites like Materialise Magics.

- A good compromise between throughput and part quality is a packing density range between 8% and 12%. However, this value can be revisited depending on application requirements.

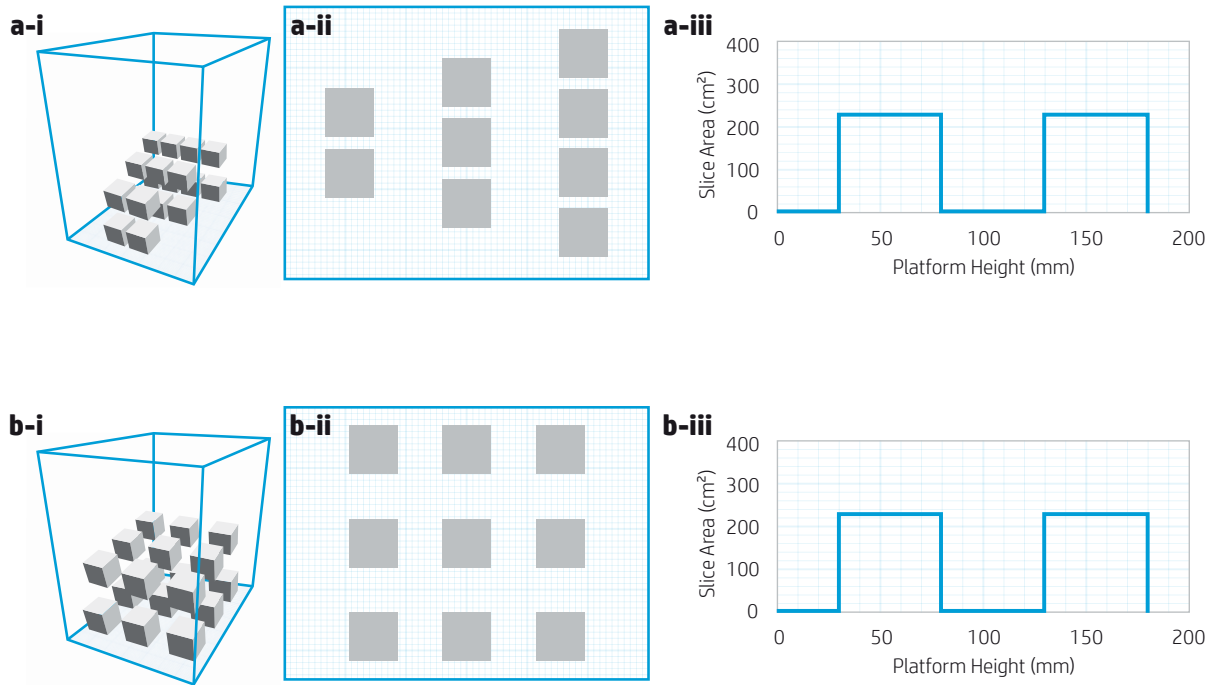

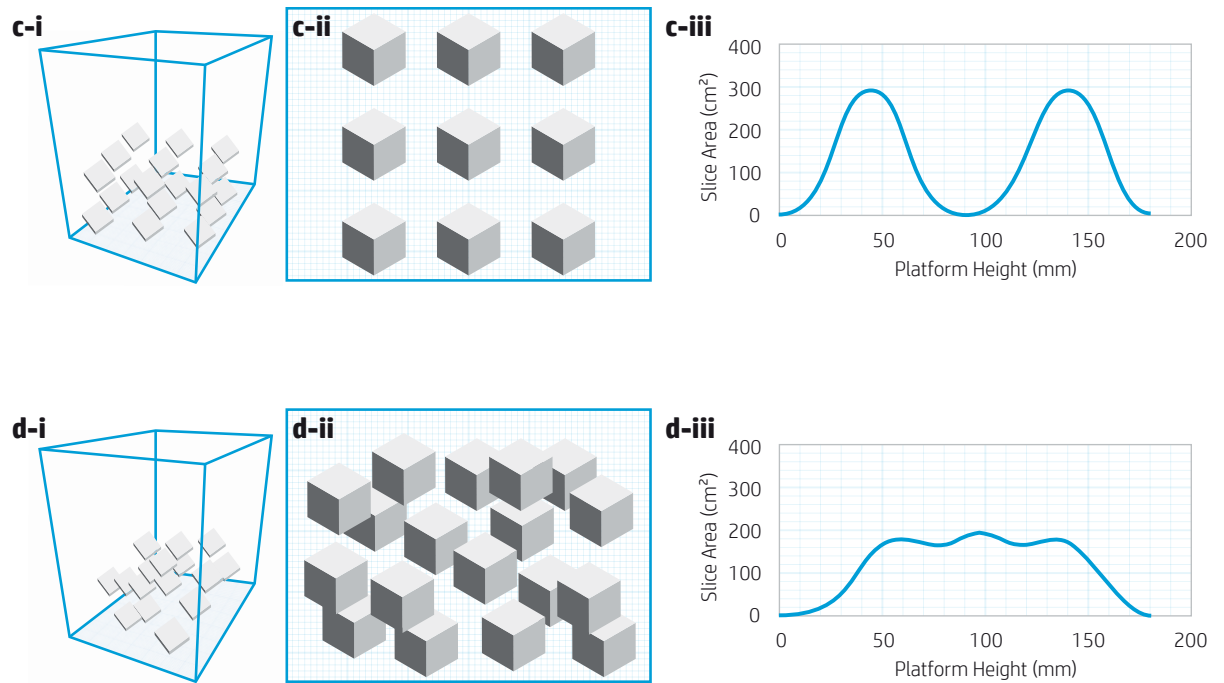

Figure 4. The printed area per layer distribution (right column) is used as an indicator of homogeneity in the Z-direction to prevent big differences in the energy absorption of parts. a) An example of a non-recommended job configuration displaying non-homogeneity in the three dimensions. b) A job that is homogeneous on the XY-plane but with a distinct and potentially problematic gap along the Z-axis. c) The gap along the Z-axis is smoother after rotating the cubes in order to prevent exposing large areas to the last layers to be printed. d) Using automatic packing, the printed area distribution is smoothed even further, minimizing adverse thermal effects. This is a recommended configuration.

Warpage concern

- When warpage is the main concern—especially for large, thin, flat parts—it is recommended to place the parts parallel to the XY-plane.
- Long parts should be placed along the Y-axis to reduce the thermal gradient even further, as this is the printing direction of the carriage.
- When printing parts prone to warpage, it is recommended to place them as centered and as low on the platform as possible. This allows them to cool more slowly, reducing the probability of warpage.
- It is recommended to print short jobs in order to minimize the Z-height—number of layers—which allows for faster printing and cooling stages.
- It is recommended to avoid fast cooling for parts prone to warpage.

Keep in mind that thin polyamide parts are not very stiff, which means that most warped parts can be effortlessly re-shaped once they are mounted in their designated place.



Thermal post-treatments can be applied to conform the material into a different shape after printing, allowing for fine-tuning of finished parts.

Dense parts

Dense parts are those with a substantial mass concentrated in a reduced volume, thus resulting in fewer cavities and walls no thicker than 15 mm to 20 mm.

- Favorable orientation is critical for parts that do not have a homogeneously distributed mass. It is recommended to print them at an angle and not along clear array patterns in order to facilitate heat distribution during printing.
- Make sure that the parts are appropriately separated (> 10-15 mm) and that the packing density does not go beyond the recommended range.



To decrease packing density, reduce the mass of the objects by hollowing them or adding internal lattices structures.

- High packing density print jobs with dense parts may result in powder deterioration and eventually impact the powder recyclability and, thus, the cost.

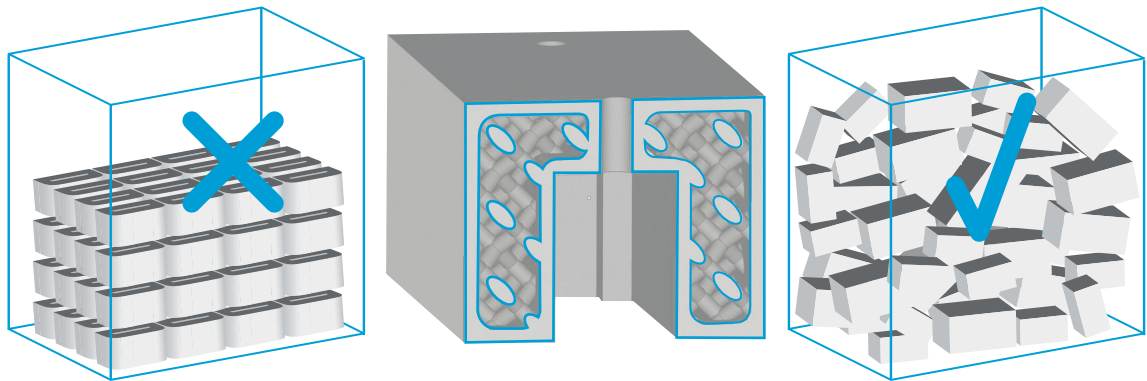

Figure 5. Left: This print job design is not recommended due to excessive packing density, dense parts, array configuration, and flat orientation. Middle: Section of a dense part that has been lightened by applying internal lattices. Right: Recommended print job configuration with lightened parts and increased part separation, tilted orientation, and more degrees of freedom during automatic packing

The recommendations are summarized in the following flowchart, which can be used as a guide for maximizing the dimensional accuracy of HP MJF–printed parts:

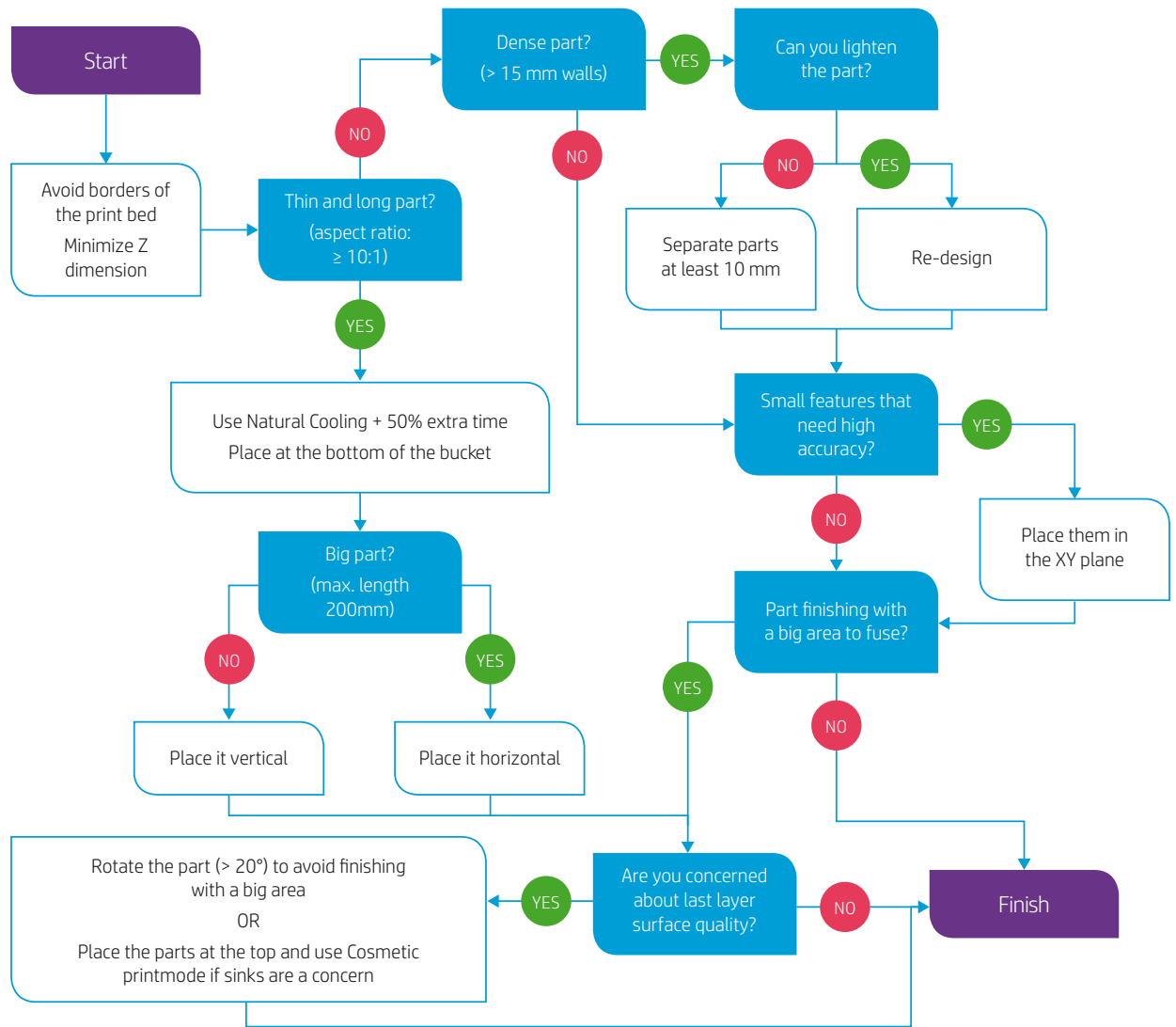

Figure 6. Dimensional accuracy flowchart

Dimensional accuracy examples

Honeycomb plate

The following example involves the printing of a honeycomb plate to maximize dimensional accuracy. This part is very similar to a big, flat plane, and therefore the object is moderately susceptible to experience warpage. However, thanks to its light honeycomb design, this deformation is not expected to be as severe as on a fully dense plate.

To maximize the accuracy and circularity of positioning holes, it is recommended to orient the part so that these features are contained on the XY-plane. This orientation minimizes the height of the part, which is compatible with the recommendations for reducing warpage and bowing.

To preserve the flatness of a part, center it as much as possible on the platform, place it in the lowest quarter, and use Slow Cooling (50% longer than the standard recommendation).

Keep in mind that placing a part flat can induce capillarity on its top face, so angle the part slightly to prevent it if this is more critical than obtaining maximum accuracy of its holes. This trade-off is reduced for HP PA 12 GB and HP PA 11 parts in Fast and Balanced print profiles, which result in similar accuracies with reduced capillarity and abraded tops.

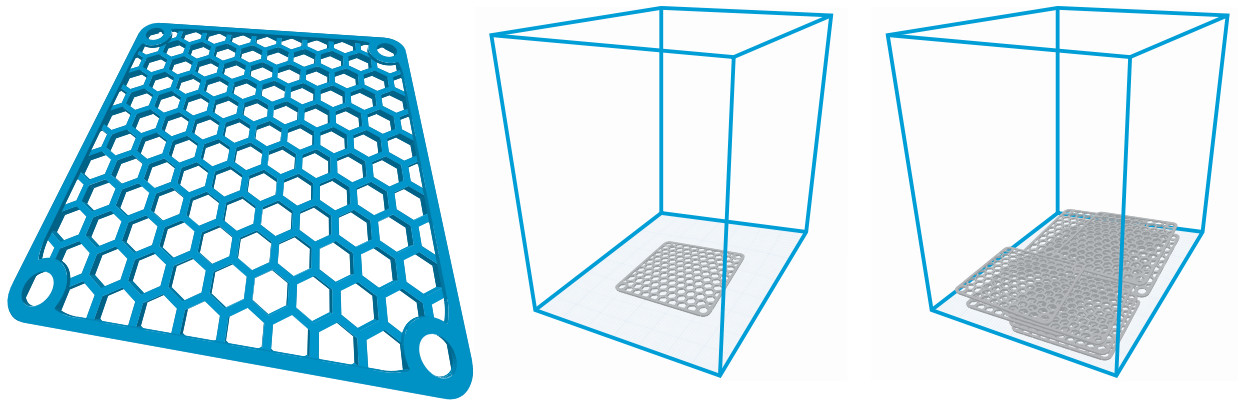

Figure 7. A honeycomb plate (left) oriented to maximize dimensional accuracy and minimize warpage. Critical features such as the positioning holes are contained on the XY-plane (middle). Right: A bucket with 10 plates in the same orientation

As shown in the figure above, in a collective scenario where several plates of this type are required, the following are recommended:

- Print short buckets (using different Build Units).
- Center the parts as much as possible.
- Make sure that a similar number of parts are being printed at each level. In the example there are either two parts or none.
- Shuffle the parts so that they do not line up along the same XY-coordinates. This allows the printing load to be shared across more printheads, extending their lifespans.
- Use extended Natural Cooling.

Phone case

The following example involves a phone case that does not require a great deal of accuracy but can potentially show warpage and bowing if not correctly oriented. This is a flat and thin part that can be considered small, and it is a good candidate for orienting perpendicularly to the XY-plane, laying on its side parallel to the Y-axis.

In this orientation, each layer is printed very quickly while the height is still short enough for the build to maintain thermal homogeneity. To minimize warpage the parts must be placed as centrally as possible, jobs should be short, and Fast Cooling should be avoided.

However, these recommendations apply mainly to HP PA 12, HP PA 12 GB, and the Fast print profile of HP PA 11, as these configurations are not significantly affected by the bowing effect if parts are printed far from the walls.

Mechanical and Balanced modes for HP PA 11 can exhibit incidences of bowing, so it is worth considering an alternative orientation. In these cases, this part should be placed flat on the XY-plane as is the case for bigger objects. The rest of the guidelines, such as using extended Natural Cooling and printing short jobs, still apply.

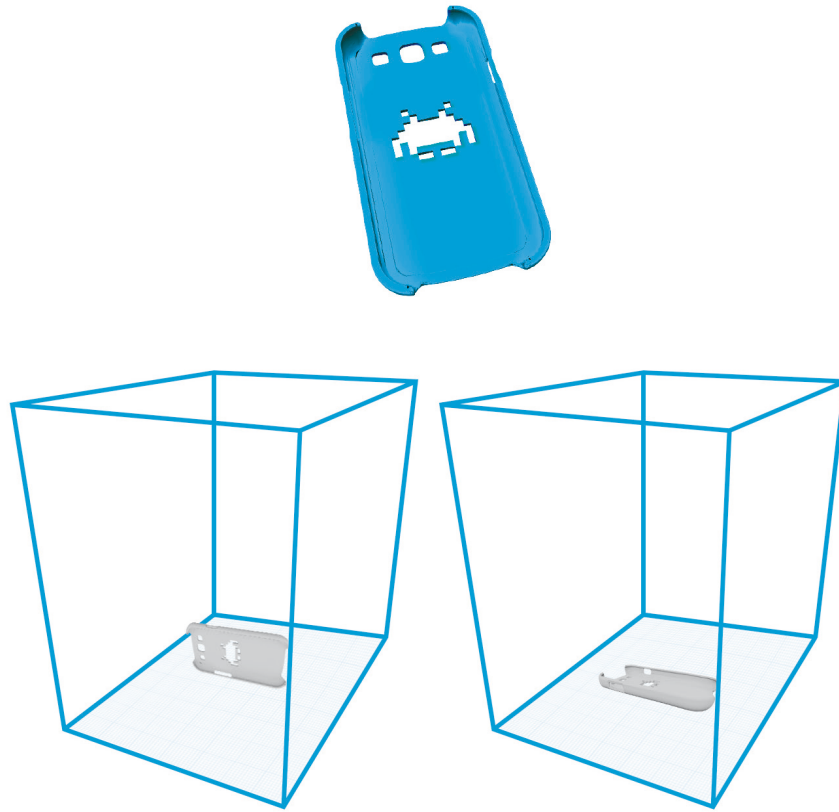

Figure 8. Left: A phone case to be printed. Middle: The suggested orientation for minimizing warpage when there is a low probability of bowing. Right: An alternative orientation that minimizes the bowing effect while still being a good option for reducing warpage





Process for aesthetic

Tuning your HP MJF technology to the design

Introduction

To maximize the look and feel of parts when 3D printing, it is important to consider the orientation and positioning of the parts in the build platform as well as the specific print profile and material used. It also is advisable to avoid situations wherein these elements are exposed to excessive or non-homogeneous heat during the printing process.

Optimizing look and feel

Printing profiles and materials

- If available for the intended material, consider using the Cosmetic print profile to maximize part look and feel.
- Consider also using HP 3D HR PA 11 (“HP PA 11”) in Fast or Balanced print profiles as it results in far fewer part quality defects. HP 3D HR PA 12 Glass Beads (“HP PA 12 GB”) also reduces the likelihood of imperfections, but the improvement with respect to HP 3D HR PA 12 (HP PA 12) is less pronounced than with HP PA 11.
- When the focus is on the appearance of the part, do not use Mechanical or non-tuned Balanced print profiles.

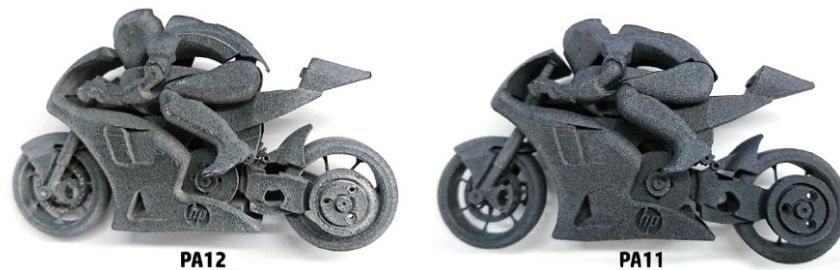

Figure 1. Look and feel of two identical parts printed with HP PA 12-Balanced (left) and HP PA 11-Mechanical (right)

Build platform placement and printing process

- Place small features such as pins, holes, and thin walls upside-down on the XY-plane to improve their look, feel, and strength. This also applies to raised texts, which should be printed on the XY-plane for maximum resolution.
- Embossed text, however, results in increased clarity when printed facing upwards.
- It is recommended to avoid upward-facing angles that are smaller than 20° between big, flat areas and the XY-plane.
- Downward-facing surfaces are typically exempt from stair-stepping if they are oriented using angles greater than 5° to 10°.

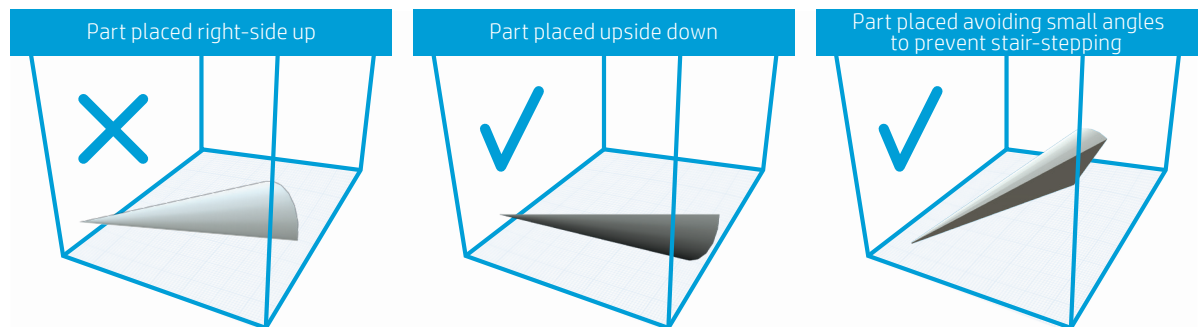

Figure 2. Orientation strategies for parts displaying curved areas to minimize the appearance of excessive layer discretization

- The recommended minimum distance between parts is 5 mm, and the ideal distance between parts and the build volume margins is between 10 mm and 20 mm.
- It is recommended to leave enough space between dense parts, or those with wall thicknesses greater than 15 mm. Normally, this distance separation should be greater than 10 mm.
- Avoid placing dense parts close to the walls of the build chamber as these artifacts mainly affect the last printed layer. Thus, it is recommended to rotate the part so that the top layers have a reduced cross-section, avoiding flat areas as much as possible.
- It is recommended to distribute the parts as homogeneously as possible on the XY-plane to facilitate similar energy absorption across the printing bed.
- Place parts in the bucket to prevent drastic changes in the printed areas per layer in the Z-direction.

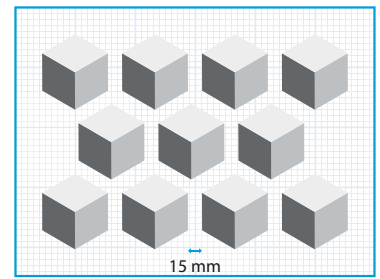

Figure 3. Recommended distance between dense parts

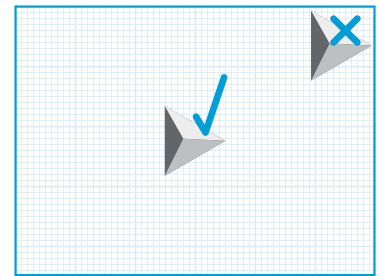

Figure 4. Recommended parts placement

Information regarding the printed area distribution is presented in certain professional software programs, such as Materialise Magics.

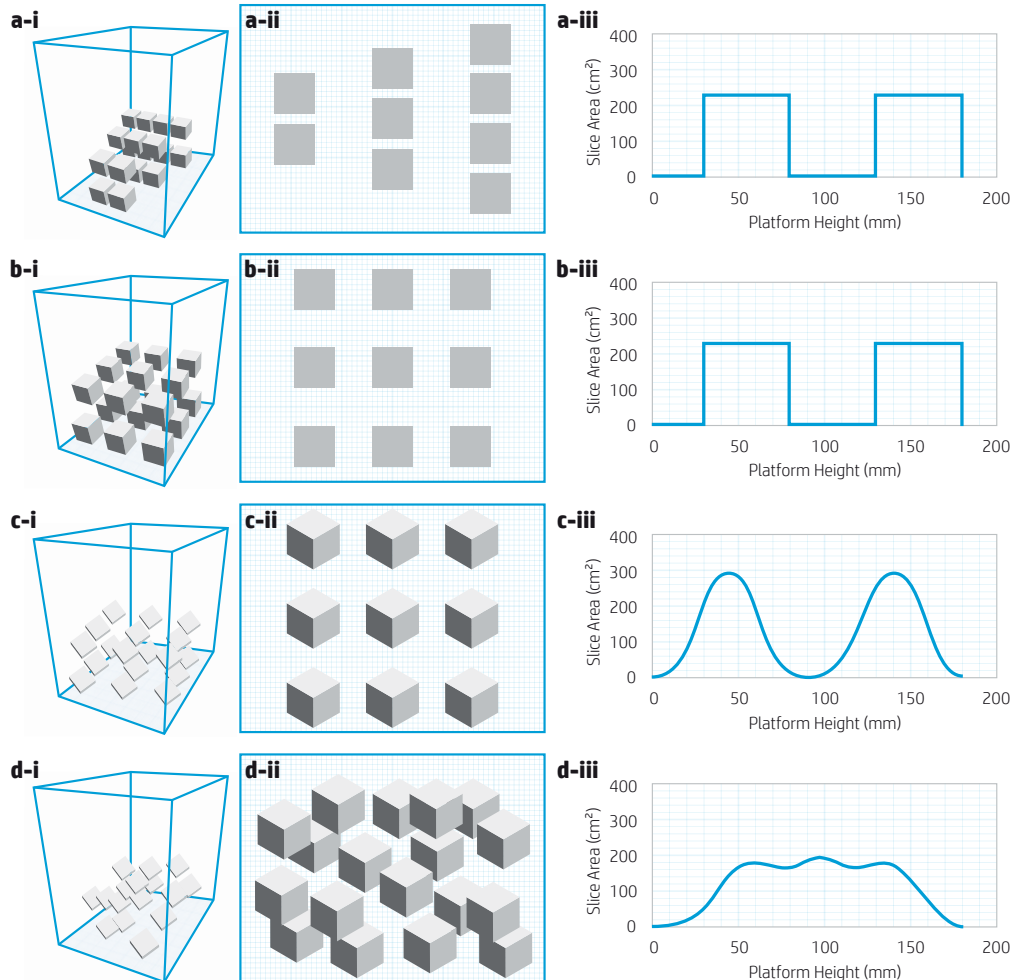

Figure 5. The printed area per layer distribution (right column) is used as an indicator of homogeneity in the Z-direction to prevent major differences in the energy absorption of parts. a) An example of a non-recommended job configuration displaying non-homogeneity in the three dimensions. b) A job that is homogeneous on the XY-plane but with a distinct and potentially problematic gap along the Z-axis. c) The gap along the Z-axis is smoother after rotating the cubes in order to prevent exposing large areas to the last layers to be printed. d) Using automatic packing, the printed area distribution is smoothed even further, minimizing adverse thermal effects. This is a recommended configuration

- Parts prone to displaying sinks or bubbles should be positioned farther away from other parts (approximately >10 mm), especially for objects directly above them (in the Z-direction). Positioning them in the top quarter of the bucket may help to reduce these effects.
- A good compromise between throughput and part quality is a packing density range between 8% and 12%. However, this value can be reassessed depending on application requirements.

The advice provided in this section is summarized in the flowchart (Figure 6), which can be used as a guide to maximize the look and feel of printed parts.

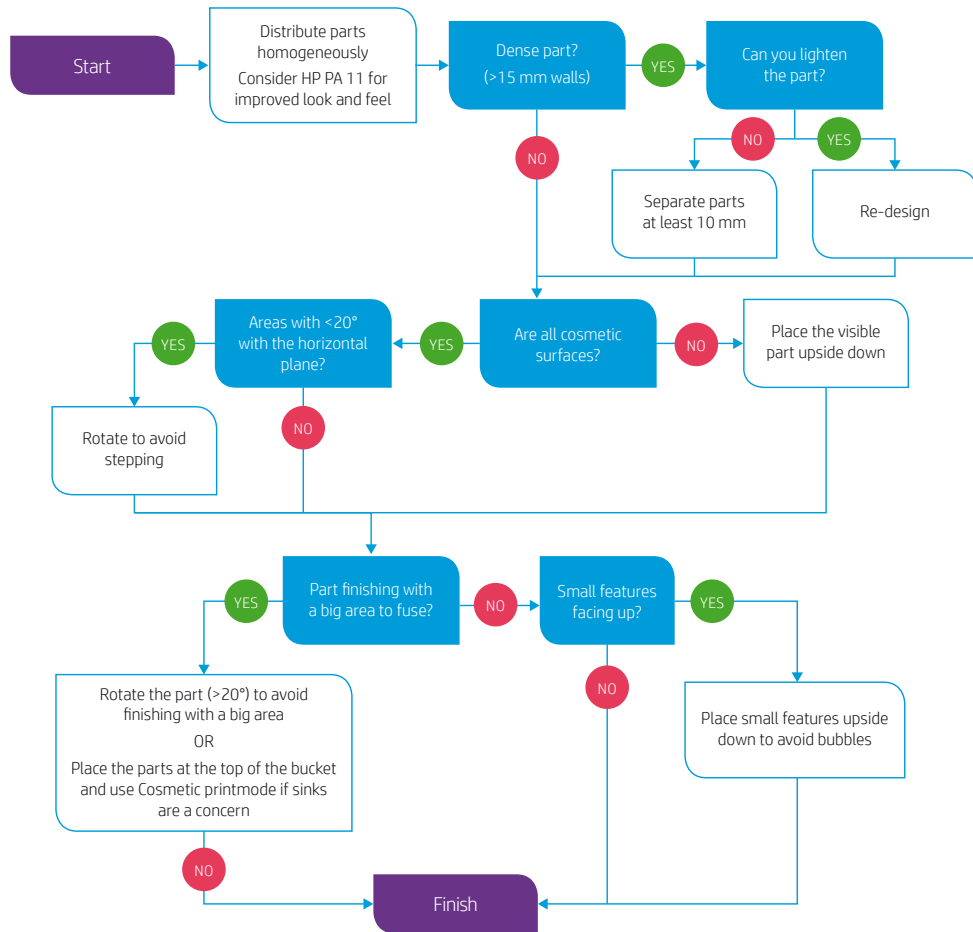
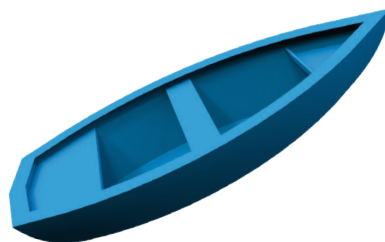

Figure 6. Flowchart for an appropriate process-parameter selection based on the geometry and functionality of a part in order to maximize its look and feel

Aesthetic example

To further illustrate the recommendations provided for cosmetic parts, below is an example involving a toy sailboat:

a



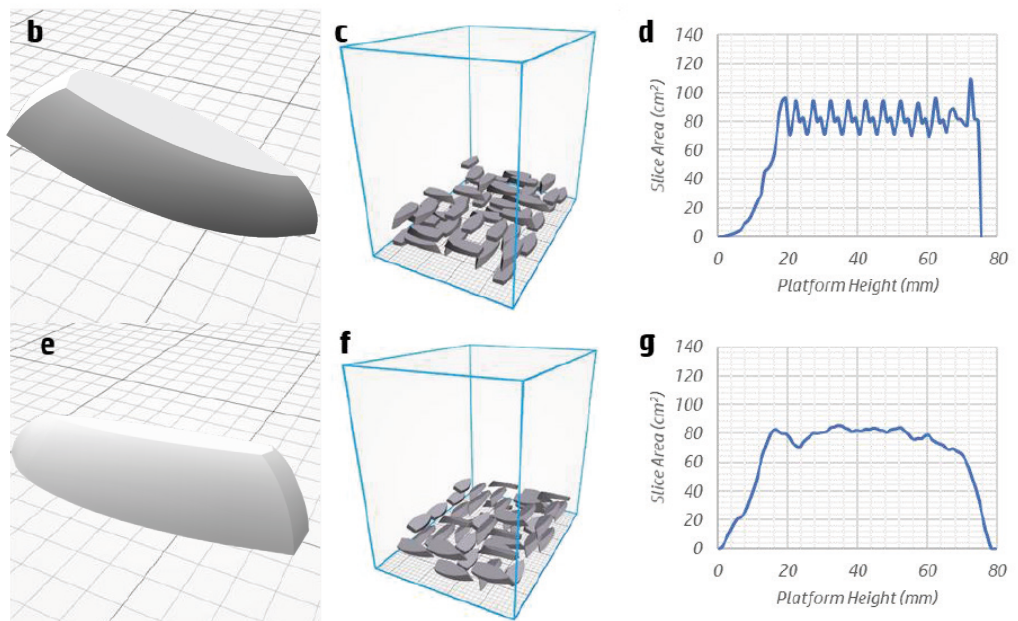

Figure 7. An example of part orientation focusing on maximizing the look and feel of a toy sailboat (a). b-d) Initial orientation stage wherein the part has a large area parallel to the XY-plane, increasing the effect of the artifacts. Fifty parts were placed, allowing rotation around the Z-axis. The area-per-layer distribution fluctuates and ends abruptly. e-g) A boat rotated 25° around its own axis in order to prevent artifacts and excessive layer-stepping. The collective area distribution with 50 boats is smoother than in the previous scenario

Since the most visible area of the object is the inside of the boat, it is clear that the part needs to be placed facing downward to provide a better finish in that section.

A first approach would be to leave it flat, but the printed area distribution of this orientation (especially in the collective case with 50 parts) ends sharply after a maximum peak, which should be avoided in order to minimize surface artifacts such as capillarity, abraded tops, and sinks.

Consequently, the boat should always be angled more than 20° in order to minimize the visibility of the individual layers. This rotation can be performed around a different axis or a combination of them. The rotation axis along the boat's length is chosen to minimize the required Z-dimension printing and smooth the printed area distributed across the many layers.

In terms of the position of the parts in the build chamber, it is best to look for the center of the platform, but there is no significant difference in the result between orienting the parts along the printing axis (X) or re-coating axis (Y). Thus, in the collective scenarios where 50 boats are printed in the same job, rotations around the Z-axis are allowed, which can increase packing density (depending on the geometry of the parts) and, more importantly, helps the required droplets to be shared across the build platform. This homogeneous distribution of the printing load is critical to prevent the over-stress of a small set of dies while leaving others idle for long periods of time.

The orientation advice for this part can be used for HP PA 12, HP PA 12 GB, and HP PA 11. However, since HP PA 11 and HP PA 12 GB typically result in reduced capillarity, a flat orientation could be applied in situations where the accuracy of some features on the XY-plane (like the hole for the sail) are critical or the height of the job is restricted.

Natural Cooling is recommended for all materials, since a faster cooling rate can lead to deviations on the flat areas with respect to their nominal shapes.

Process for mechanical properties

Tuning your HP MJF technology to the design



Introduction

Selecting the proper printing and cooling profile, printing part material, or placing the part in a specific orientation in the build platform are a few ways to maximize the mechanical properties of a 3D-printed part.

Maximizing mechanical properties

There are several considerations that must be evaluated before printing a part in order to increase its mechanical performance:

Printing profiles and materials

- Mechanical and Balanced are the print profiles that yield the best mechanical properties for both HP 3D HR PA 11 (“HP PA 11”) and HP 3D HR PA 12 (“HP PA 12”) materials, with the former exhibiting better results.
- HP PA 11 provides higher elongation and impact resistance¹ than HP PA 12, while HP 3D HR PA 12 Glass Beads (“HP PA 12 GB”) results in higher tensile moduli while reducing elongation and tensile strength.²
- Using Cosmetic (HP PA 12) or Fast (HP PA 11 and HP PA 12) print profiles is not recommended for applications with high mechanical requirements.

Build platform placement and printing process

- The recommended minimum distance between parts is 5 mm, and the ideal distance between parts and the build volume margins is 10 mm to 20 mm.
- It is recommended to leave enough space between dense parts, or those with wall thicknesses larger than 15 mm. Normally, this distance should be more than 10 mm.
- In cases where many parts with the same shape are tightly packed with parallel main surfaces, treat them as dense parts and increase the distance between them.

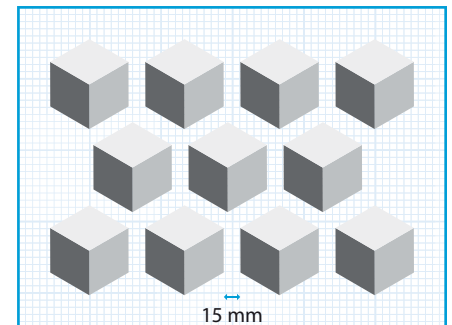

Figure 1. Recommended distance between dense parts

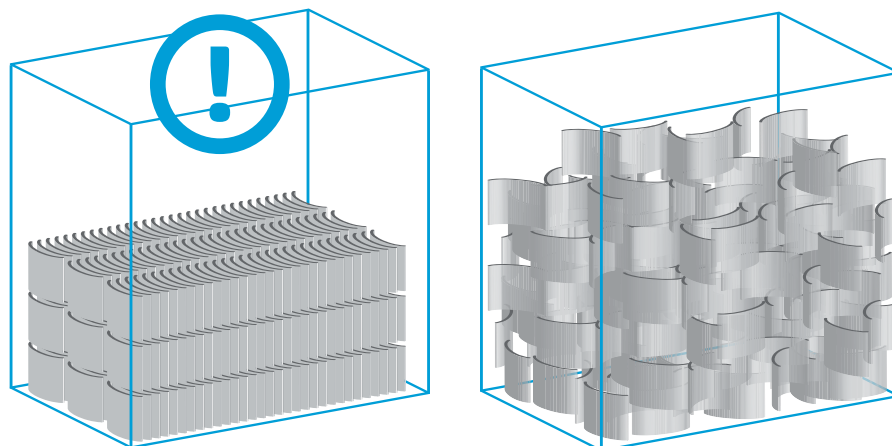

Figure 2. Left: Many parts arranged in a configuration that can result in excess heat. Right: Alternative configuration that increases heat homogeneity and facilitates dissipation, resulting in better results overall

- It is recommended to distribute the parts as homogeneously as possible on the XY-plane to facilitate similar energy absorption across the printing bed.

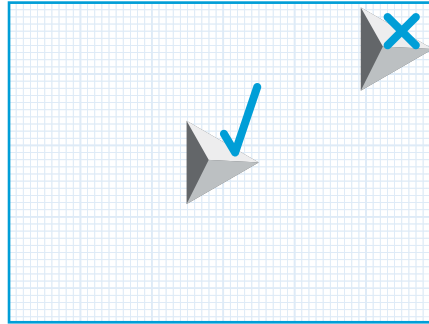

Figure 3. Recommended parts placement

- As well as in the XY-plane, it is recommended to place the parts in the bucket to prevent drastic changes in the printed areas per layer in the Z-direction.

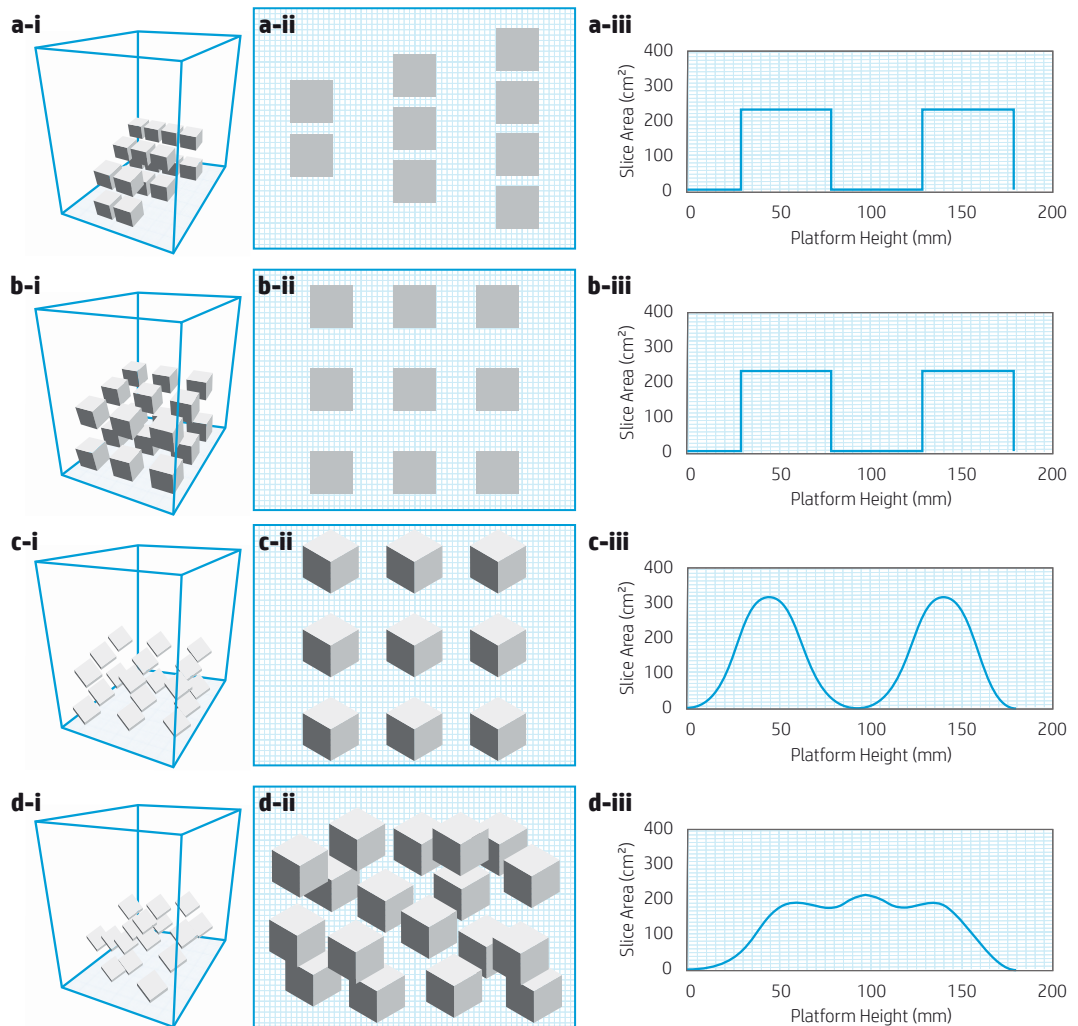

Figure 4. The printed area per layer distribution (right column) is used as an indicator of homogeneity in the Z-direction to prevent major differences in the energy absorption of parts

- An example of a non-recommended job configuration displaying non-homogeneity in the three dimensions
- A job that is homogeneous on the XY-plane but with a distinct and potentially problematic gap along the Z-axis
- The gap along the Z-axis is smoother after rotating the cubes in order to avoid exposing large areas to the last layers to be printed
- Using automatic packing, the printed area distribution is smoothed even further, minimizing adverse thermal effects. This is a recommended configuration



Information about the printed area distribution is available from professional suites like Materialise Magics.

- When optimizing mechanical properties, a good compromise between throughput and part quality is a packing density range between 8% and 10%.
- Using a low packing density improves the heat management between parts, which increases positive results through homogeneity.
- It is recommended to print short jobs in order to minimize the Z-height—number of layers—which allows for faster printing and cooling stages, and to increase the elongation at breakpoints and impact resistance of parts.
- Fast Cooling has a similar beneficial effect on elongation at breakpoints and impact resistance, but it should not be used for parts prone to warpage. This is especially critical for HP PA 11, which is more prone to warpage.

Mechanical examples

Below is an example of a part orientation for a part that requires increased elongation and impact resistance in its thinner features:

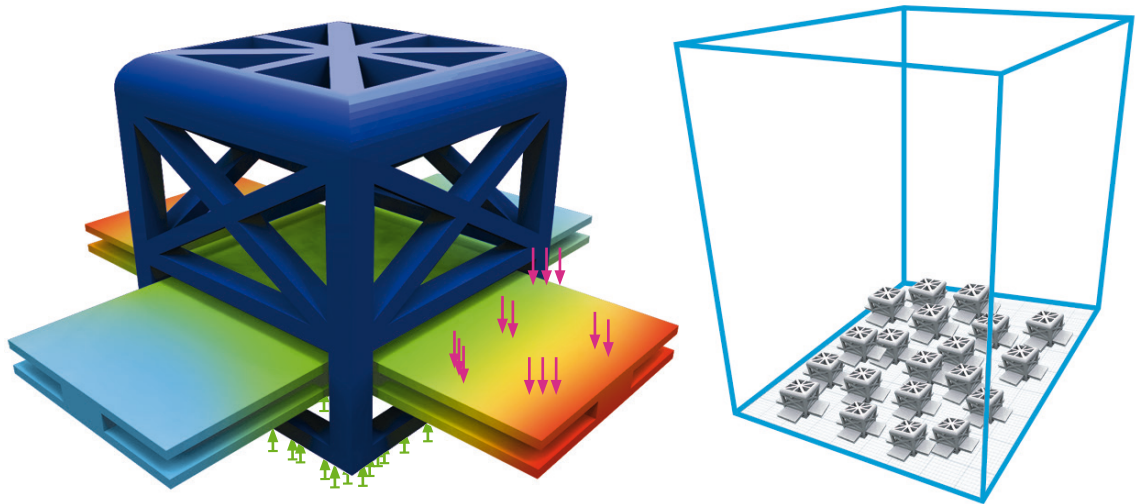

Figure 5. Left: A mechanical part with high elongation requirements on its thinner features
Right: A short bucket containing 20 iterations of the same part

As mentioned previously, process factors such as print profiles, cooling profiles, and job heights are key factors in achieving better mechanical properties.

Thus, to obtain high elongation and impact resistance values, it is recommended to use a Mechanical print profile, to cool the parts as fast as possible, and to print shorter jobs (minimizing Z-height) with low packing densities.

The choice of Mechanical print profiles for both HP PA 11 and in HP PA 12 entails a trade-off in dimensional accuracy. However, this is not an issue for the present application. Similarly, Fast Cooling would most likely induce warpage on thinner features, but their flatness in this case is not as relevant as their elongation, which would be boosted with faster cooling.

In terms of materials, the Mechanical print profile for HP PA 11 would result in higher elongation than its HP PA 12 counterpart, even without using Fast Cooling. HP PA 12 GB would not be a good choice of material for this application since it typically results in stiffer parts that tend to snap rather than bend.

-
1. Based on internal testing and public data for solutions on market as of April, 2016. Cost analysis based on: standard solution configuration price, supplies price, and maintenance costs recommended by manufacturer. Common cost criteria: using HP 3D High Reusability PA 11 material, and the powder reusability ratio recommended by manufacturer. HP Jet Fusion 3D 4200 Printing Solution average printing cost per part is lower than the average cost of selective laser sintering (SLS) printer solutions from \$100,000 to \$300,000 USD. Cost criteria: printing 1 build chamber per day/5 days per week over 1 year of 30 cm³ parts at 10% packing density.
 2. Testing according to ASTM D638, ASTM D256, and ASTM D648 using HDT at different loads with a 3D scanner for dimensional stability. Testing monitored using statistical process controls.

©Copyright 2019 HP Development Company, L.P. The information contained herein is subject to change without notice.

The information contained herein is provided for information purposes only. The only terms and conditions governing the sale of HP 3D printer solutions are those set forth in a written sales agreement. The only warranties for HP products and services are set forth in the express warranty statements accompanying such products and services. Nothing herein should be construed as constituting an additional warranty or additional binding terms and conditions. HP shall not be liable for technical or editorial errors or omissions contained herein and the information herein is subject to change without notice.



Machining recommendations

Tuning your HP MJF technology to the design



Introduction

HP Multi Jet Fusion (MJF) technology allows for the design and production of accurate parts with small features, complex geometries, and functional assemblies. These advantages can be enhanced by adding complementary post-processes such as machining, especially for applications where very tight tolerances are required such as small threads, bearing housings, or engineering fits.

A machining post-process can add value to the following aspects:

- **Dimensional accuracy:** A standard machining post-process can provide very tight tolerances—up to ± 0.05 mm—in a particular area or for a critical feature where high function and tolerance are required.
- **Geometry references:** In addition to dimensional accuracy, a machining post-process can also improve geometric requirements like flatness, concentricity, perpendicularity, or parallelism, reaching very tight tolerances up to ± 0.08 mm.
- **Small features:** A machining post-process also allows for the implementation of small features such as small threads, ensuring accurate results.
- **Surface roughness:** By default, the mean surface roughness or roughness average (Ra) of a part that is 3D printed using HP MJF technology is between $8\ \mu\text{m}$ and $12\ \mu\text{m}$, depending on the face orientation. This surface roughness can be significantly improved with machining post-processes such as milling or turning, which have roughness values of up to $0.30\ \mu\text{m}$ and $0.60\ \mu\text{m}$, respectively.
- **Repeatability:** A machining post-process can also decrease the variation in applications that require repeatable specs.



Please note that some plastics cannot be machined. The more rigid the plastic, the easier it is to be machined. Cutting tools used in machining rely on the rigidity of the component. Some reinforced plastics would behave better than less rigid plastics, which tend to bend and require expertise to be machined to achieve high accuracy. Softer and flexible plastics are not suitable for machining.

Design recommendations

When designing a part for HP MJF, it is important to bear in mind the requirements for the final part. Some applications may require adjustments in the design in order to machine the printed part accordingly.

Surface grinding

This abrasive post-process removes material to create very flat surfaces with fine finishes and very accurate tolerances. For this reason, the machined surface needs to be designed with additional material to achieve a suitable result. The minimum recommended thickness is 0.5 mm, bearing in mind that an excess of material will lead to increased costs as well as manufacturing and post-processing time.



Surface grinding also allows for the improvement of the part's surface roughness.

Process recommendations

When machining a part for HP MJF, it is important to select the right parameters for each post-process in order to achieve a suitable result.

Milling

When milling a part for HP MJF, the recommended machining parameters are as follows:

Operation	Through holes (direct diameter)	Through holes (large diameter)	Face grinding	Turret heights
Tool recommended	Drill of required diameter	Drill of Ø12	End mill of Ø63 with interchangeable inserts	End mill of Ø8
RPM recommended	4000	10000	6000	6000
Cutting speed recommended	200 mm/min	2000 mm/min	1000 mm/min	1000 mm/min
Depth of cut recommended	1 mm	1 mm	0.25 mm	0.25 mm
Other comments	NA	Helical interpolation	NA	Helical interpolation

Table 1: Milling recommended parameters



Using metal cutting tools can lead to high temperatures, which can worsen the surface finishing and dimensional tolerances due to the melting of the material.

Turning

When turning a part for HP MJF, the recommended machining parameters are as follows:

Operation	Facing	Cylindrical facing	Boring	Reaming
Tool recommended	Cutting tool	Cutting tool	Drill of required diameter	Reamer of required diameter
RPM recommended	650	650	500	150
Cutting speed recommended	50-100 mm/min	50-100 mm/min	200 mm/min	200 mm/min
Depth of cut recommended	0.5 mm	0.5 mm	NA	NA

Table 2: Turning recommended parameters



When turning big series of parts, it is recommended to use custom tools made from widia or cobalt. In addition, to achieve good results and avoid vibrations, customized chucks can also be used.

Coolant and lubrication

Although an HP MJF part can be machined without the aid of air or water cooling, it is highly recommended to use air cooling.

Cutting fluid also can be used if the part is attached with chucks and if the part is not going to be painted or the surface is not going to be treated in some way. For holes deeper than 10 mm, it is highly recommended to use the cutting fluid as the chips cannot be removed easily.

©Copyright 2019 HP Development Company, L.P. The information contained herein is subject to change without notice.

The information contained herein is provided for information purposes only. The only terms and conditions governing the sale of HP 3D printer solutions are those set forth in a written sales agreement. The only warranties for HP products and services are set forth in the express warranty statements accompanying such products and services. Nothing herein should be construed as constituting an additional warranty or additional binding terms and conditions. HP shall not be liable for technical or editorial errors or omissions contained herein and the information herein is subject to change without notice.





Design for interlocking parts

Innovative designs

Introduction

This chapter is intended as a design-oriented tool that combines reference, instruction, and inspiration, and should remain relevant as digital manufacturing processes and technologies continue to evolve. Expect to find answers to specific questions and needs, or stumble across something new to try in your digital manufacturing journey.

Chains

Basics

Chains are assemblies of interlocked links. With powder-based 3D printing, these interlocking assemblies can be printed in one go, as long as they are designed with sufficient gaps.

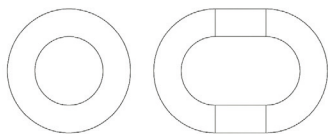

Figure 1: Example of basic links

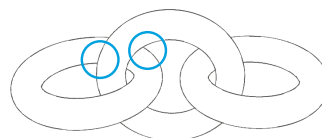

Figure 2: Ensure sufficient gaps to prevent accidental fusing

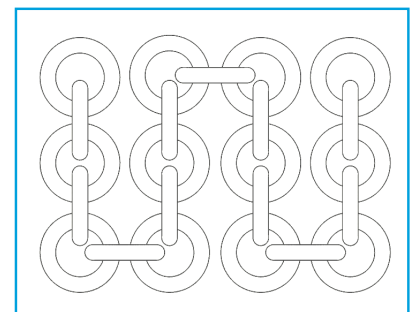

Figure 3: You can also design chains folded for compact packing and for printing parts that are longer than the print bed's dimensions.

Modifications

Thanks to 3D printing, links can be infinitely complex. They can be differently shaped, adorned, and even have additional moving parts. You can also blend different kinds of links or change scales.

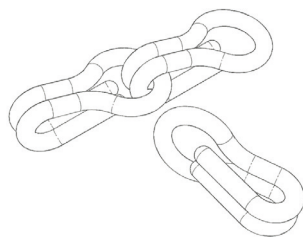

Figure 4: This chain link features an opening, which allows the chain to be re-configured after printing, as needed.

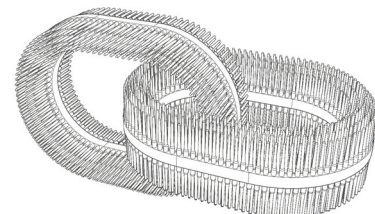

Figure 5: Textures can be added, such as the fur-like surface on the links above.

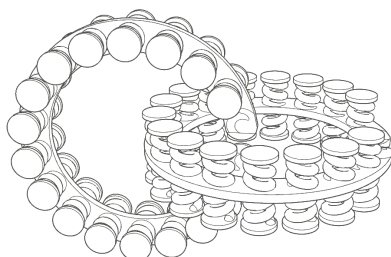

Figure 6: These rings feature both springs for texture and openings for re-configurability.

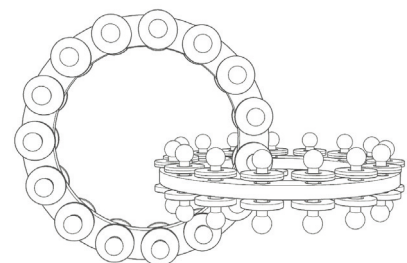

Figure 7: The disks "riveted" on these links add both acoustic and tactile properties.

Packing chains

Orientation

To avoid vertical and horizontal links, which can be cosmetically (and perhaps mechanically) different, print the chain with each link at a 45-degree angle to the print bed, alternating between -45 and +45 degrees with respect to the vertical direction.



Figure 8: Chain links oriented at 0 and 90 degrees to the print bed



Figure 9: Chain links oriented at -45 and +45 degrees to the print bed

Packing

Some chains are too long to fit in one layer of the print bed. One option is to print them in layers and then use one or more vertical links to connect the last link of a layer to the start of the one above. However, to avoid having any links (the vertical links) that look different from the others, print the chains in coiled cylinders, as shown to the left.

Start with the links at 45 degrees to the print bed and then angle each link slightly in vertical and horizontal directions. This is more easily achieved via scripting than laying out the chain by hand, but it can be done either way.

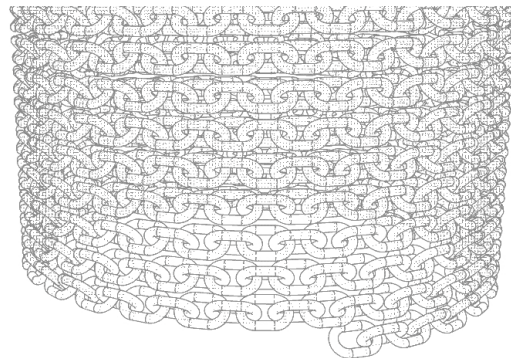

Figure 10: The bottom of a cylinder containing a chain more than 40 feet long

Measuring printed length

Note that the printed length of the chain will be longer than its apparent length in the model to be printed since the links must not touch each other while printing. The length of the final chain can be calculated as shown below. Designers may need to take this kind of expansion into account for more complicated interlocking designs like chainmail.



$$\text{Printed Length} = (\text{number}_{\text{of links}} \times \text{length}_{\text{of link}}) - (\text{number}_{\text{of links}} - 1) \times (2 \times \text{thickness}_{\text{of links}})$$

If the chain is attached to something using its first and last links, subtract another two more thicknesses of link.

Chainmail

Basics

Chainmail is a basic textile-like structure that can be made from interlocked chain links. With 3D printing, entire sheets can be printed at once. They can also be printed and folded to be larger than the print bed.

A basic four-in-one chainmail features four rings interlocking into every one, but there are many different varieties of chainmail.

An excellent resource for further tutorials is <http://www.maillageartisans.org/>.

How-to

For every individual ring, four other rings intersect. Ensure there are sufficient gaps, so that none of the four rings intersect with either the base ring or each other.

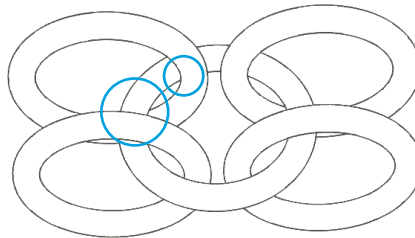

Figure 11: Ensure sufficient gaps to prevent accidental fusing

These units can be repeated in rows. In this particular example, the rings are rotated to create a 90-degree angle with one another, as each row is alternatively rotated 45 degrees clockwise or counterclockwise. However, this angle can be increased or decreased according to the design.

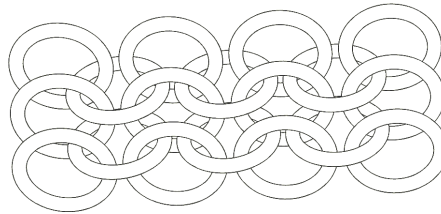

Figure 12: Chainmail design example

Modifications

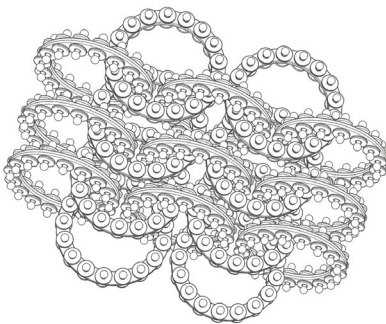

Figure 13: The "riveted" disks from the chains example also work well for chainmail.

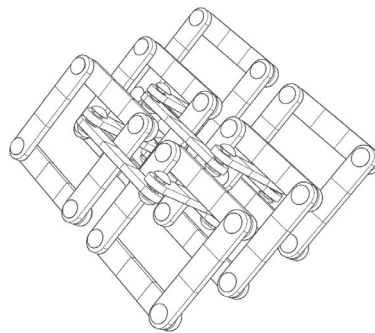

Figure 14: These hinged diamonds result in a chainmail with additional expanding properties at the link level.

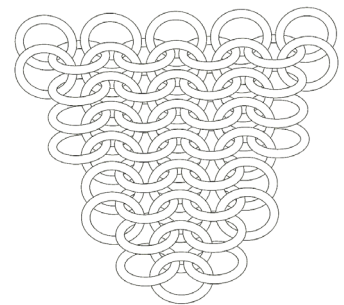

Figure 15: Chainmail pieces can also be trimmed and shaped in CAD, prior to printing.

Beyond four-in-one

3D printing makes it easier to create interlocking pieces that use more than just circles or ellipses. The following example interlocks flowers with ellipses, but you can create intricate fabrics of unlimited designs.

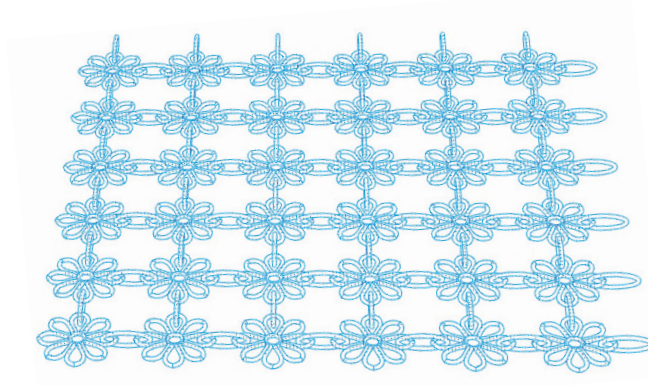

Figure 16: Chainmail design interlocking flowers with ellipses

The chainmail to the right consists of stars and two sizes of circles. The small circles connect the stars to the big circles. Note that the big circles are laid out below the stars for a more compact print job and to avoid accidental fusing. This uses a hexagonal linking pattern.

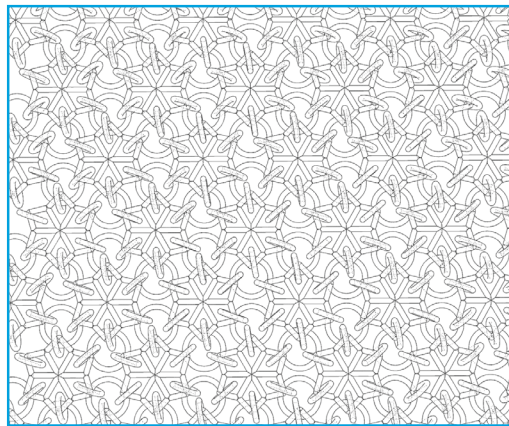

Figure 17: Chainmail design interlocking stars with circles of two different sizes

Printed examples



Figure 18: Starry chainmail

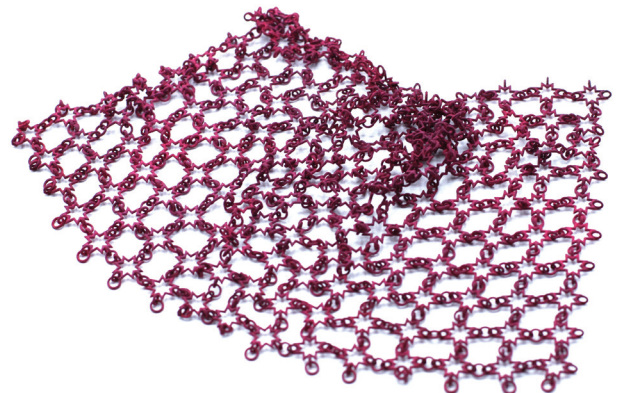

Figure 19: Star fabric

Quad-based “fabric”

Base elements

This design draws inspiration from metal fabrics, like those found in some vintage handbags. There are two base elements to this structure:

- A ring (can be a torus, extruded circle, or even octagon)
- A platform unit with four “legs.” In the example shown, the legs taper inward and emerge from a flat octagonal base.

Make sure there is a large enough gap between elements on all sides to prevent them from fusing together.

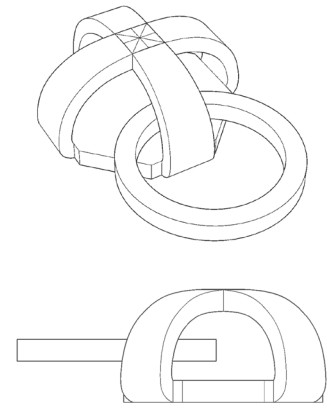

Figure 20: If your elements are too thin, they may print successfully but will fall apart in sandblasting!

Scaling

Each ring connects to four platform units, and each platform unit holds four rings. The swatch can be repeated as much as you want (or as much as will fit in your print bed). The design can also be printed folded over.

Make sure there is sufficient spacing between the elements. The proportion of ring size to platform unit size will also dictate the visual quality of the mesh and warrants experimentation.

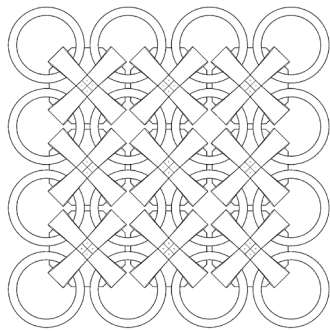

Figure 21: Connection between quad-based “fabric” elements

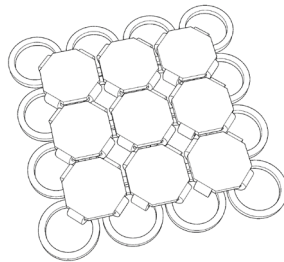

Figure 22: A quad-based “fabric” example

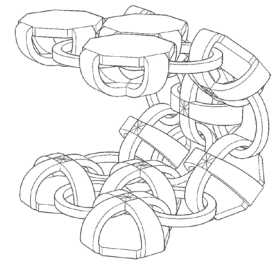

Figure 23: The folded elements shown here are bent 45, 90, and 135 degrees.

Variations

3D printing means there’s no reason the platform unit has to be flat. Here are some examples of alternative surfaces.

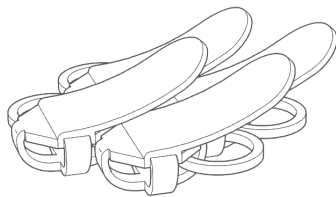

Figure 24: A layered wave pattern obscures the gaps between units.

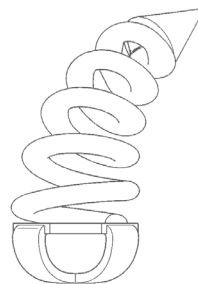

Figure 25: Springs result in novel textures.

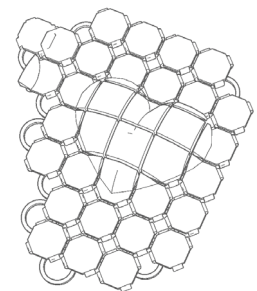

Figure 26: Create “pixelated” 3D images along the surface.

Single link mesh

How-to

3D printing allows for the combination and simplification of forms.

For example, a singular unit of angled rings can result in a single shape that can be arrayed to create a mesh.

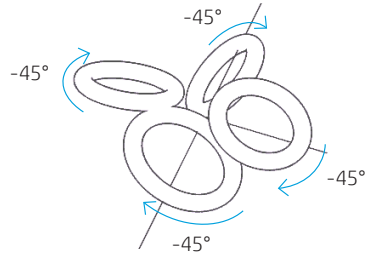

Figure 27: Angled rings resulting in a single shape

However, the shape also can be combined and reduced, only retaining the critical angles for proper interlocking.

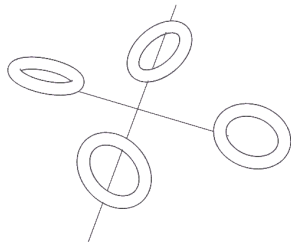

Figure 28: Angled and reduced rings

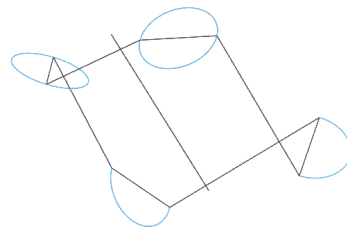

Figure 29: Angled and reduced rings resulting in a single shape

The optimized unit uses less material and looks more continuous.

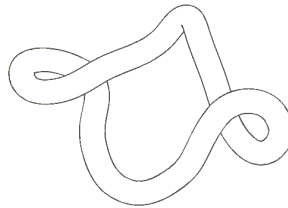

Figure 30: Optimized unit from angled and reduced rings

Example results

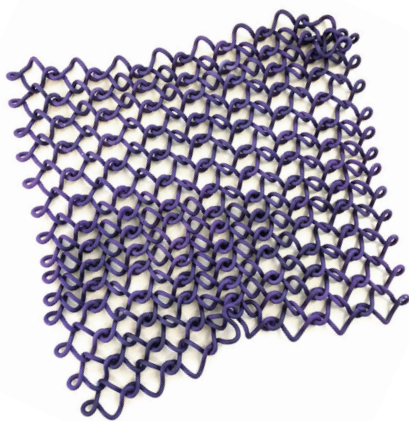

Figure 31: This design also allows for tighter vertical compression, allowing larger sheets to be printed.

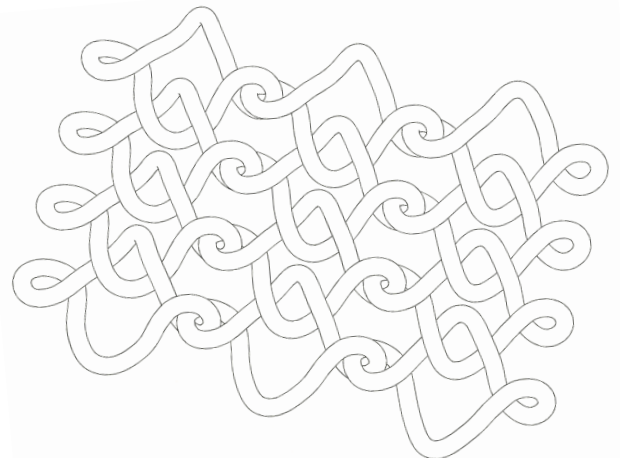

Figure 32: Design of a single link mesh

Six-in-one weave chainmail

Basics

A six-in-one weave is slightly stiffer than a four-in-one weave, and grows in a radial fashion more easily than the preceding quad-based chainmails and meshes. Generally, this weave is made of two sizes of rings, with six smaller rings fitting into one larger one.

The rings do not necessarily have to be circular. Also, the example link shown features six spokes separating the rings. However, this is a stylistic and optional choice.

Each smaller ring connects two larger ones. The increased number of connection links causes the structure to somewhat resist folding, though it is still flexible and movable.

You can also experiment with this type of interlocking design with more or fewer connection links, instead of six, to modify stiffness.

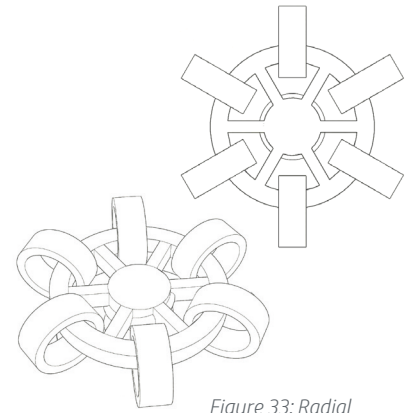

Figure 33: Radial growth design

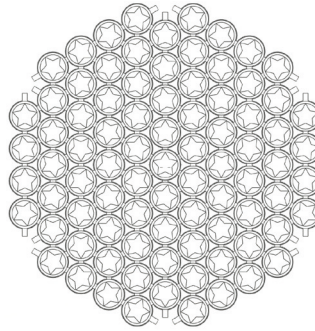

Figure 34: An example of a six-in-one weave chainmail

Modifications and applications

The flat plane provided by the larger rings provides an opportunity for developing more advanced structures.

In this example link, the spokes support a decorative panel on a flexible spring. The decorative panel gives the weave a more solid look, while the spring provides texture.

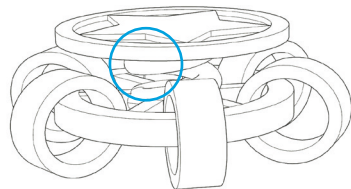

Figure 35: Make sure that any additional structures have sufficient clearance from the rings.

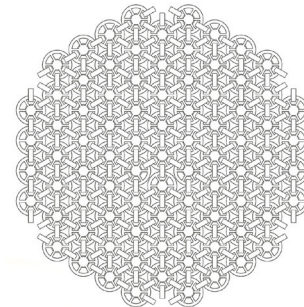

Figure 36: An advanced six-in-one weave chainmail

One example application benefiting from this structure's radial nature is a bucket hat.

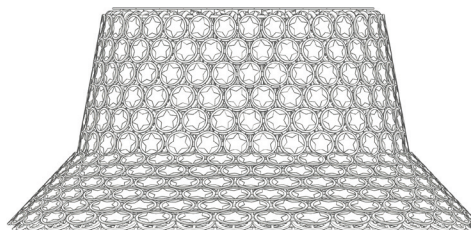

Figure 37: Bucket hat design

Hexagon-based “fabric”

A different kind of drape

As long as the elements can be easily tiled, different types of grids like this one are possible. This example uses a “sandwich” of hexagons connected by posts and linked together with triangles that circle around posts. This creates a fabric with no “wrong” side.

Hexagonal grids provide more degrees of freedom for draping compared to the quad fabrics shown before, but the use of posts here instead of the arches in the quad example can lead to a stiffer fabric if the posts are not tall enough to provide much movement.

We can easily adjust the flexibility, drape, sturdiness, weight, and other parameters of the fabric by varying the thickness of the hexagons, the height of the posts connecting the hexagons, the size of the triangle connectors, and so forth. The example fabric shown also has holes in the center of the hexagons to make it easier to clean via sandblasting.

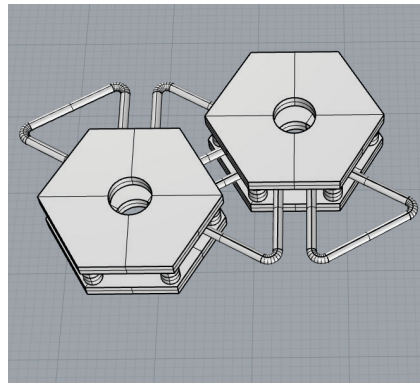

Figure 38: More information on these hexagonal units is available on the next page.

Creating larger sheets

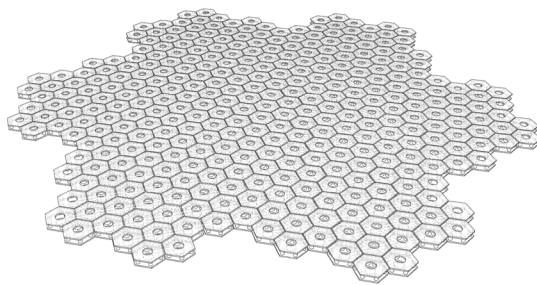

Figure 39: Hexagonal fabrics can be thought of as polar arrays instead of grids, leading to snowflake-like shapes.

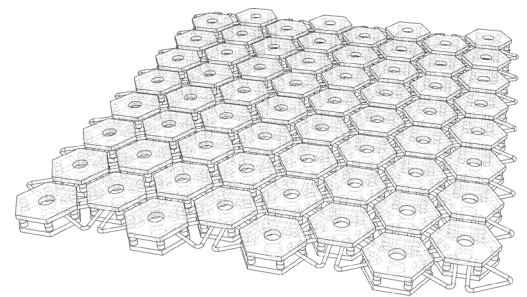

Figure 40: The easiest tiling unit to use, which is mentioned on the next page, naturally leads to offset rows and columns.

Tiling units

General considerations

For chainmail and fabric swatches, and even 3D cuboid structures, we design a “tiling unit” to lay out along one (as in a chain), two, or three dimensions. The tiling unit has connectors at the edges for the directions along which we want to tile it.

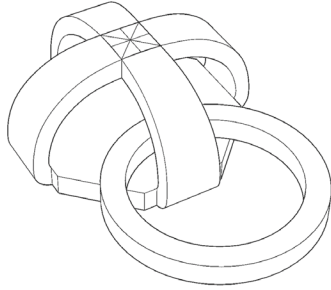

Figure 41: The quad fabric's tiling unit consists of a square with legs and a connector on the bottom right edge.

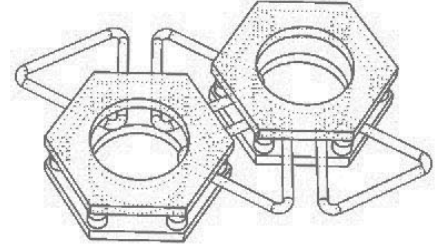

Figure 42: The hexagonal fabric uses a tiling unit consisting of a base hexagon with another one rotated to its upper right side. There are two connectors on the top of the base hexagon, and two on the bottom of the rotated hexagon.

Tiling units lend themselves to an array of functions in CAD design tools, and especially to scripting. We just determine the space we want between the units so they connect well and do not accidentally fuse. The other parameter is the number of units along the dimensions we want to tile.

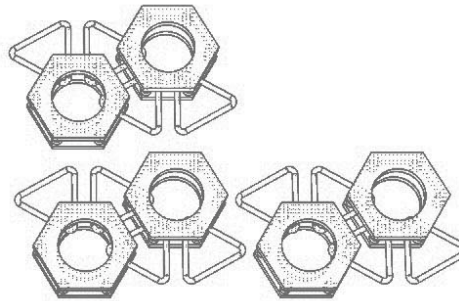

Figure 43: This example shows the hexagonal tiles in X and Y directions pulled away from each other so we can see how they connect.

Layering

3D printing allows us to combine techniques and create fabrics with several layers. This offers a great deal of room for experimentation.

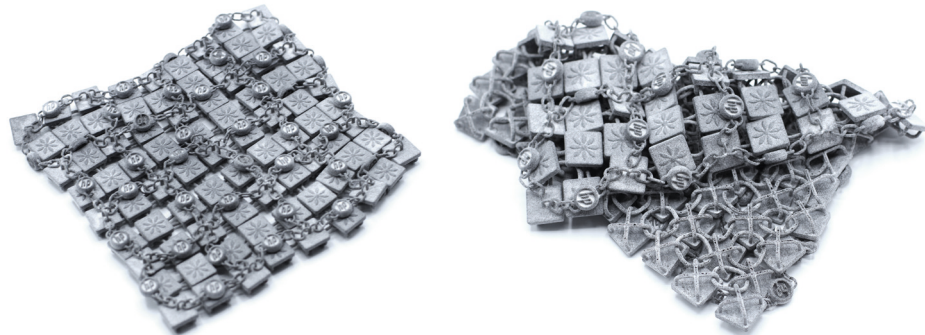

Figure 44: This example uses a quad fabric with embossed flowers and a second layer of chains and logos.

Applying interlocking swatches

Trimming

Sheets can be trimmed in CAD prior to printing to create the desired final outcomes. This is much less wasteful than printing full sheets and editing them after.

Sheets can also be folded to create larger parts, like in this shirt example.

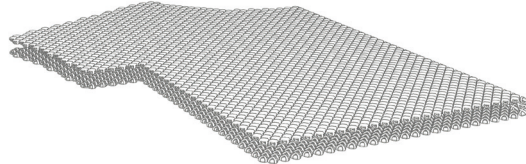

Figure 45: A shirt designed from folded sheets

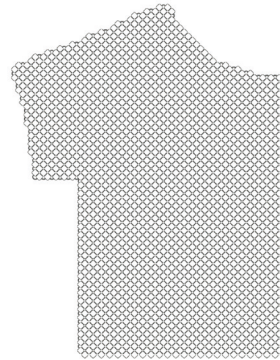

Figure 46: Top view of a shirt design

Seaming

You can design in edges to your interlocking structures by combining sheet-like structures with chain structures. Adding this border cleans up the edges.

Doing so also creates an easier, more aesthetically pleasing way to connect separate parts. For example, the skirt panel on the left can be combined with four others, with ribbon woven through the chain trim, to make a final design.

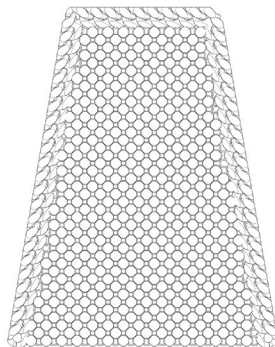

Figure 47: Sheet-like structures combined with chain structures

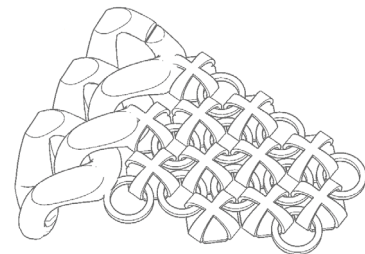

Figure 48: Edge detail

Stretching

Interlocking structure designs can also be stretched and deformed to fill in the desired shape. However, be sure to double check that the transformation does not reduce the clearance between parts too much for successful printing.



Figure 47: Bucket hat design with stretched and deformed interlocking structures

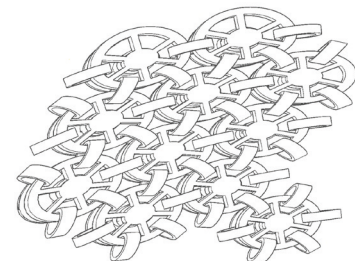

Figure 48: Design detail

Case study : 3D printed skirt

Context

Textiles have been refined over centuries of innovation, so 3D printing will likely not replace our standard daily clothing. However, in certain contexts, like the fashion-forward, open desert music festival of Coachella, an easy-to-clean plastic skirt fits right in and makes good sense.

Overall design

This skirt uses a large-grain version of the Quad-Based Mesh structure. The larger size, with 1.2 mm-thick rings holding 10 mm-wide platform units together, is robust enough to hold up, even when coming into contact with a rough dusty field. The mesh is still fine enough to create natural and comfortable movement.

Design optimization

Given HP MJF's efficient XY speed, connecting flat panels is the most efficient approach to creating the skirt. The panels were tapered to create a basic, flattering, five-panel skirt. Each panel was then lined with a thicker, twisted chain to create smooth edges and easy attachment points for final assembly.

Ribbons are woven through the chains to stitch the panels to each other. One final ribbon is threaded along the top edges. Due to the chains' compressive qualities, this ribbon helps create an adjustable waistband.

After days of wear at Coachella, the skirt was simply rinsed off with a hose and brought back to HP Labs, where it now resides in the Immersive Experiences Lab's Living Room Lab.

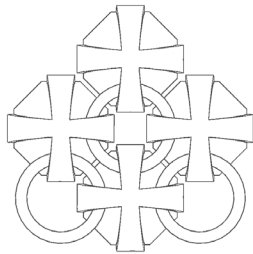

Figure 49: Design detail

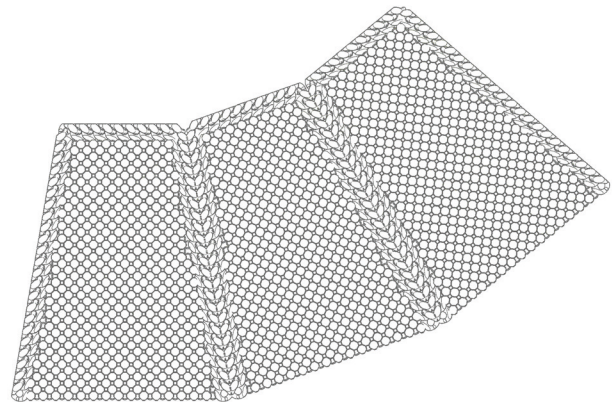

Figure 50: 3D printed skirt design

©Copyright 2019 HP Development Company, L.P. The information contained herein is subject to change without notice.

The information contained herein is provided for information purposes only. The only terms and conditions governing the sale of HP 3D printer solutions are those set forth in a written sales agreement. The only warranties for HP products and services are set forth in the express warranty statements accompanying such products and services. Nothing herein should be construed as constituting an additional warranty or additional binding terms and conditions. HP shall not be liable for technical or editorial errors or omissions contained herein and the information herein is subject to change without notice.



Hinge design

Innovative designs



General introduction

Hinges are another type of interlocking part that can be printed as a single assembly. Here, too, there must be sufficient space around the interconnecting pieces to prevent them from fusing together. There are several different kinds of hinges, and because of the space required around the different pieces, different types of hinge designs will be more wobbly than others.

Scaling

These two hinges are very similar; they both have two pieces that connect to an object on the left, and a middle piece that connects to an object on the right. They both have a rod that goes through the centers of the hinge pieces and gaps each end.

However, for the one on the left, the middle piece rotates around the rod, as do the pieces connecting to the left. For the hinge on the right, the rod and middle piece are one solid piece, so it is only the top and bottom parts of the hinge that rotate around the rod.

This second hinge wobbles less because there does not need to be any space between the middle piece and the rod. They are one piece.

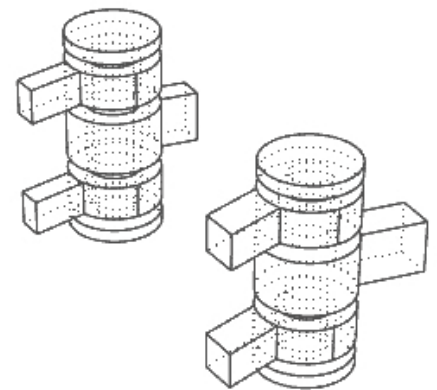

Figure 1: Examples of hinge design strategies

Examples



Figure 2: This intricate egg features a tiny hinge connecting its two halves.



Figure 3: Another type of hinge uses cones that fit into matching divets. These modules can snap apart and back together.

Living hinges

Basics

It is possible to print a finitely flexible part with HP 3D HR PA 12 by adjusting its wall thickness and geometric structure. A thin and folded section performs like a living hinge, and it allows 3D printed parts to be collapsible and expandable to a certain degree.

To design and print flexible parts successfully, it is important to have an appropriate wall thickness; to maintain the curves and angles of folded hinges when converting the model to mesh; and to specify the print orientation.

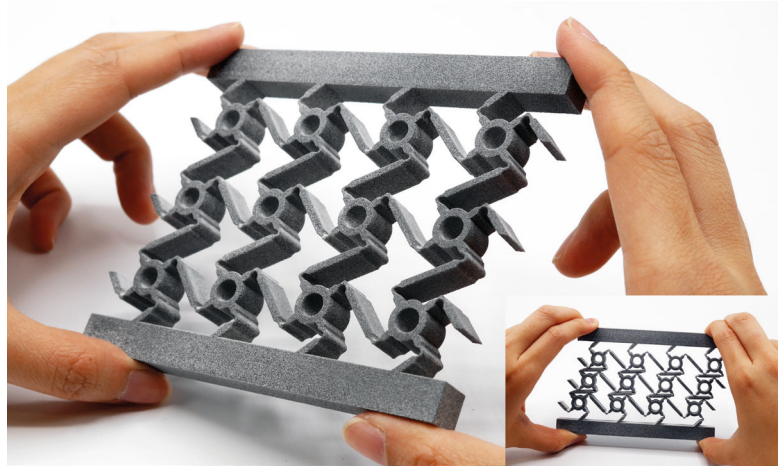

Figure 4: An array of living hinges, collapsible by hand

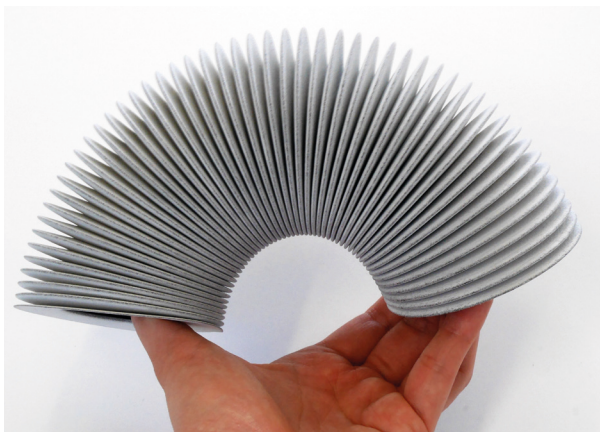

Figure 5: Tube with cosine-curve shaped walls

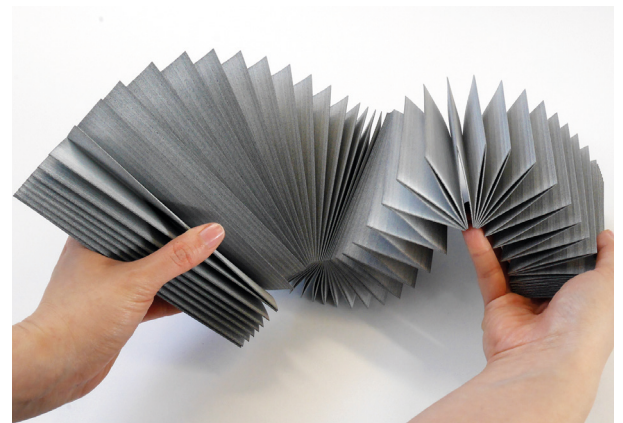

Figure 6: Accordion structure composed of a number of connected plates

Wall thickness

Even a difference in wall thickness of 0.1 mm has a great impact on the degree of the part's flexibility, and if walls are too thin, the part will not survive cleaning and sandblasting. It is recommended to experiment with varied and controlled wall thicknesses to find the suitable resilience and robustness for a part's purpose.

Geometry of structures

A part's structural geometry controls its mechanical behavior when outside force is applied. Different folding designs can be applied to create specific effects, such as springy tension and smooth motion. The shape and tightness of the folding has a direct impact on a part's movement. Make the apex of the fold hinge slightly rounded to avoid the risk of being snapped when the printed part is stretched or pressed.

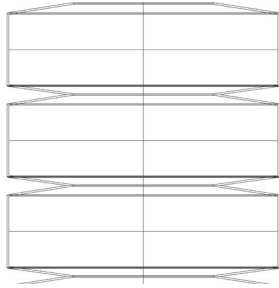

Figure 7: V-shaped connectors create springy tension in the folds.

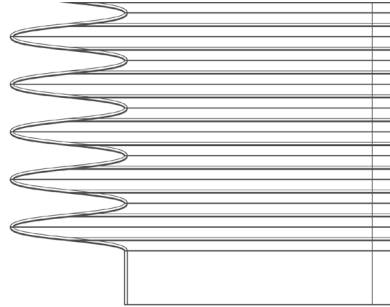

Figure 8: Cosine curve shapes create smooth motion.

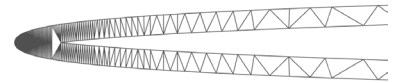

Figure 9: The highly dense mesh applied to the accordion structure maintains the folds' roundness.

Print orientation

To maximize the durability of the thin structure, it is recommended to print the part in an orientation such that its thin planes are approximately parallel with the X/Y plane. Specific print modes, such as mechanical mode and fast cooling, can be used to maximize elongation at the break point of the part if necessary.

There are some exceptions where thin parts benefit from being printed at an angle, such as the tambourine shown under "Designing for Sound."

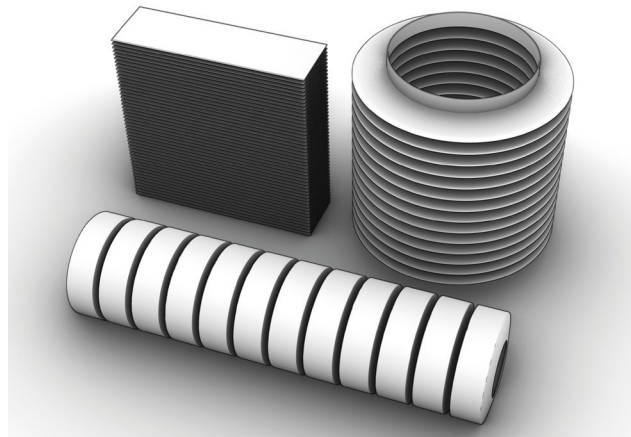

Figure 10: Recommended print orientation for sample designs

©Copyright 2019 HP Development Company, L.P. The information contained herein is subject to change without notice.

The information contained herein is provided for information purposes only. The only terms and conditions governing the sale of HP 3D printer solutions are those set forth in a written sales agreement. The only warranties for HP products and services are set forth in the express warranty statements accompanying such products and services. Nothing herein should be construed as constituting an additional warranty or additional binding terms and conditions. HP shall not be liable for technical or editorial errors or omissions contained herein and the information herein is subject to change without notice.





Design for sound

Innovative designs

Acoustic interactivity

An often-overlooked aspect of a 3D printed part is the sound it makes. We can deliberately design parts to achieve particular sounds.



Figure 1: For example, thin mobile pieces that contact each other when shaken can create a soft, silvery sound



Figure 2: Large hollow parts with reasonably thin walls and holes can create a nice resonance. In the example above, the cut-out "tongues" on the drum act like cantilevers. The tone they generate is a function of the mass of the cantilever and is therefore controlled by thickness, length, shape, and cross section



Figure 3: You can also 3D print percussive membranes, like the tambourine pictured above. Printing the tambourine with the membrane side down at a 30-degree angle helps avoid warpage of the membrane

Case study: pneumatic instruments

Designing in sections

By combining a bellow structure with other components, it is possible to make 3D printed pneumatic devices and musical instruments. The bellow parts demonstrated here are robust and flexible enough to survive sandblasting, and generate air pressure when compressed.

The prototypes consist of more than one part so that excess powder can be removed from the air chambers. They are then assembled into functional objects. The air channels in the parts are also designed to be a reasonable size to ensure that all excess powder can be released through them.

- This air pump is composed of two parts: a bellow and air valve. It blows air out when the bellow is pressed.

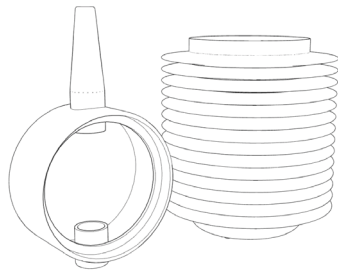

Figure 4: Air pump design

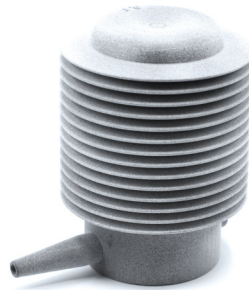

Figure 5: 3D printed air pump



Figure 6: Bellow being pressed

- This musical instrument makes a funny sound when played. A 3D printed whistle also can be attached to make a more tuned sound.

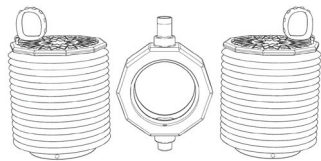

Figure 7: Musical instrument design

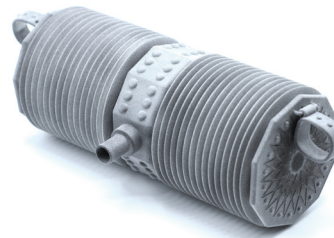

Figure 8: 3D printed musical instrument

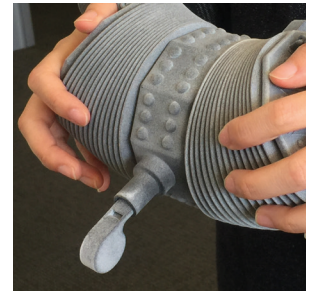

Figure 9: 3D printed musical instrument being played

- This pneumatic device can be controlled with an electronic pump. When the bellow is inflated by the pump, it expands and pushes the flexible mesh panel upward. To prevent air leakage, a pressure washer and O-ring are attached to the screw joint parts of the bellow and cap.

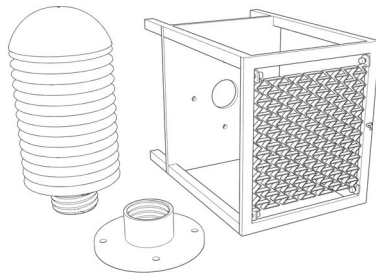

Figure 10: Pneumatic device design

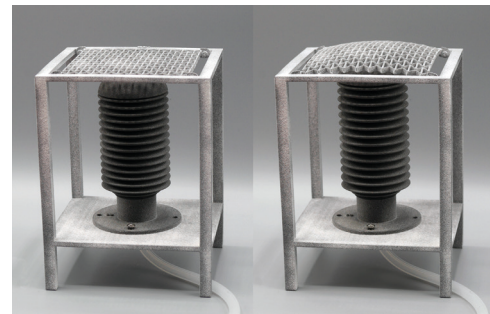

Figure 11: 3D printed pneumatic device

©Copyright 2019 HP Development Company, L.P. The information contained herein is subject to change without notice.

The information contained herein is provided for information purposes only. The only terms and conditions governing the sale of HP 3D printer solutions are those set forth in a written sales agreement. The only warranties for HP products and services are set forth in the express warranty statements accompanying such products and services. Nothing herein should be construed as constituting an additional warranty or additional binding terms and conditions. HP shall not be liable for technical or editorial errors or omissions contained herein and the information herein is subject to change without notice.

