



# Central Chillers

OPERATION,  
INSTALLATION AND  
MAINTENANCE  
MANUAL

Accuchiller TSE



Where water  
means business.





# Table of Contents

---

Foreword .....	1
Safety Guidelines .....	1
Pre-Installation .....	2
Receiving Inspection .....	2
Unit Storage.....	3
Installation - Chiller .....	3
Foundation .....	3
Unit Location .....	3
Rigging .....	3
Process Fluid Piping .....	3
Condenser Water Piping.....	3
Water Pressure Gauges.....	4
System Temperature Sensor .....	4
Chiller Flow Sensor.....	4
Installation - Remote Condenser.....	5
Location.....	5
Table 1 - Condenser Clearance Requirements .....	5
Flat Coil Condenser Foot Mounting.....	5
Figure 1 - Mounting Legs.....	6
Lifting .....	6
Interconnecting Refrigerant Piping.....	6
Refrigeration Piping Design .....	6
Figure 2 – Condenser Located at Chiller Level.....	7
Figure 3 – Condenser Located Below Chiller Unit .....	7
Figure 4 - Condenser Located Above Chiller Unit.....	7
Determining Equivalent Line Length .....	7
Table 2 – Equivalent Lengths of Elbows .....	7
Liquid Line Sizing.....	7
Table 3 – Liquid Line Sizes for R410A and R454B .....	8
Discharge (Hot Gas) Line Sizing.....	11
Figure 5 – Vertical Riser Traps.....	11
Figure 6 - Double Discharge Riser.....	11
Table 4 - Horizontal or Downflow Discharge Line Sizes for R410A and R454B (inches OD) .....	11
Table 5 - Upflow Discharge Line Sizes for R410A and R454B (inches OD) .....	12
Calculating Refrigerant and Oil Charge.....	12
Table 6 – Chiller and Condenser Refrigerant Charge.....	13
Table 7 - Field Piping Refrigerant Charges .....	13
Oil Charge Determination .....	13
Installation - Electrical.....	13
Control Operation .....	15
Screen Navigation .....	15
System Initialization.....	15
Figure 7 – Start-Up Splash Screen.....	15
Home – Chiller Home Screen.....	16
System Overview .....	16
Figure 8 – Chiller Home Screen .....	16

Table 8 – System Overview Functions.....	16
Starting and Stopping the Chiller.....	17
Starting the Chiller.....	17
Figure 9 – Chiller Start.....	17
Stopping the Chiller.....	17
Figure 10 – Chiller Stop.....	17
Menu 1 - Overview.....	17
Figure 11 – Menu 1 Screen.....	17
Menu 2 - Overview.....	17
Figure 12 – Menu 2 Screen.....	17
Menu 1 - Alarms.....	18
Alarms Active.....	18
Figure 13 –Alarms Active Handler.....	18
Alarms History.....	18
Figure 14 – Alarm History.....	18
Warning Glycol.....	18
Figure 15 – Warning Antifreeze.....	18
Menu 1 – Diagnostics.....	19
Diagnostics Menu.....	19
Figure 16 – Diagnostics Menu Screen.....	19
Figure 17 – Diagnostics Circuit Details Screen.....	19
Figure 18 – Diagnostics Circuit Interlock Screen.....	19
Figure 19 – Diagnostics Pumps Screen.....	19
Figure 20 – Chiller Tank Screen.....	19
Figure 21 – Diagnostics Process Screen.....	19
Figure 22 – Diagnostics Hardware Screen.....	19
Figure 23 – Diagnostics Import/Export Data Screen.....	20
Figure 24 – Diagnostics Overview Screen.....	20
Menu 1 – Security.....	20
Security Menu.....	20
Figure 25 - Security Menu.....	20
Figure 26 - Security – Log In Screen.....	20
Figure 27 - Security – Add User Screen.....	20
Figure 28 - Security – Edit User Screen.....	20
Figure 29 - Security – Delete User Screen.....	20
Figure 30 - Security – Change Password Screen.....	21
Table 9 - Security – Users and Passwords.....	21
Menu 1 – Inputs / Outputs.....	21
Figure 31 - Main Inputs/Outputs Screen.....	21
Figure 32 - Inputs/Outputs – Temperature Inputs Screen.....	21
Figure 33 - Inputs/Outputs – Pressure Inputs Screen.....	21
Figure 34 - Inputs/Outputs – Analog Inputs Screen.....	21
Figure 35 - Inputs/Outputs – Digital Inputs Screen.....	21
Figure 36 - Inputs/Outputs – Analog Outputs Screen.....	22
Figure 37 - Inputs/Outputs – Digital Outputs Screen.....	22
Figure 38 - Inputs/Outputs – Digital Outputs Screen.....	22
Menu 1 – User Setup.....	22

Figure 39 - User Setup - Menu 1 Screen.....	22
Figure 40 - User Setup - Menu 2 Screen.....	22
Figure 41 - User Setup - Menu 3 Screen.....	22
Figure 42 - User Setup - Menu 4 Screen.....	23
Figure 43- User Setup - Menu 5 Screen.....	23
<b>User Setup – Alarm Setup .....</b>	<b>23</b>
Figure 44 - User Setup - Alarm Setup Screen.....	23
Table 10 – Alarm Setup Parameters.....	23
<b>User Setup – Hot Gas Bypass .....</b>	<b>24</b>
Figure 45 - User Setup – Hot Gas Bypass Setup Screen .....	24
Table 11 – Hot Gas Bypass Valve Setup Parameters .....	24
<b>User Setup – Pump Control .....</b>	<b>24</b>
Pump Control Screen.....	24
Figure 46 - User Setup – Pumps Screen (Dedicated Backups) .....	24
Figure 47 - User Setup – Pumps Screen (Dual Standby) .....	24
Figure 48 - User Setup – Pumps VFD.....	24
<b>User Setup – EEV Control .....</b>	<b>25</b>
Figure 49 - User Setup – EEV Control Setup Screen.....	25
Table 12 – EEV Control Setup Parameters.....	25
<b>User Setup – Compressor Staging .....</b>	<b>25</b>
Figure 50 - User Setup – Compressor Staging Setup Screen .....	25
Table 13 – Compressor Staging Setup Parameters .....	25
<b>User Setup – Stage Order.....</b>	<b>26</b>
Compressor Stage Order Screen.....	26
Figure 51 - User Setup – Stage Order Setup Screen .....	26
Table 14 – Stage Order Setup Parameters .....	26
<b>User Setup – Discharge Control Setup.....</b>	<b>26</b>
Discharge Control Setup Screen.....	26
Figure 52 - User Setup – Discharge Control Setup Screen.....	26
Table 15 – Discharge Control Setup Parameters.....	26
Figure 53 - User Setup – Discharge Control Setup Screen (Remote Air Cooled) .....	26
Table 16 – Discharge Control Setup Parameters.....	27
<b>User Setup – Dynamic Lift Setup .....</b>	<b>27</b>
Dynamic Lift Setup Screen.....	27
Figure 54 - User Setup – Dynamic Lift Setup Screen .....	27
Table 17 – Dynamic Lift Parameters.....	27
<b>User Setup – Serial Communications Setup.....</b>	<b>27</b>
Modbus RTU Setup Screen.....	27
Figure 55 - User Setup – Modbus RTU Setup Screen .....	27
<b>User Setup – Temperature Retransmit .....</b>	<b>27</b>
Figure 56 - User Setup – Temperature Retransmit Setup Screen .....	27
<b>User Setup – IP Address.....</b>	<b>27</b>
Figure 57 - User Setup – IP Address Setup Screen .....	27
<b>User Setup – Units.....</b>	<b>28</b>
Figure 58 - User Setup – Display Units Setup Screen .....	28

User Setup – Remote Setpoint .....	28
Figure 59 - User Setup – Remote Setpoint Setup Screen .....	28
User Setup – Primary / Secondary .....	28
Figure 60 - User Setup – Primary / Secondary Setup Screen.....	28
User Setup – Chiller Capacity.....	28
Chiller Capacity Screen.....	28
Figure 61 - User Setup – Chiller Capacity Setup Screen .....	28
User Setup – Date/Time .....	28
Date/Time Screen.....	28
Figure 62 - User Setup – Date / Time Setup Screen.....	28
User Setup – Pump Down .....	29
Pump Down Screen .....	29
Figure 63 - User Setup – Pump Down Setup Screen.....	29
User Setup – Evaporator Valve .....	29
Evaporator Valve Control Screen .....	29
Figure 64 - User Setup – Evaporator Valve Control Setup Screen.....	29
User Setup – Misc. Process Control .....	29
User Setup – Misc. Local Mode.....	29
User Setup – Misc. Automatic Start.....	29
User Setup – Misc. Current Sensors .....	29
Figure 65 - User Setup – Miscellaneous Control Setup Screen .....	29
User Setup – Chiller Tank and Water Makeup .....	30
Figure 66 - User Setup – Chiller Tank and Water Makeup Setup Screen .....	30
User Setup – Short Cycle .....	30
Figure 67 – Short Cycle Enabled Screen.....	30
Figure 68 – Short Cycle Disabled Screen .....	30
Menu 1 – Trending.....	30
Figure 69 - System Trending 1 Screen.....	30
Figure 70 - System Trending 2 Screen.....	30
Figure 71 - System Trending 3 Screen.....	30
Figure 72 - System Trending 4 Screen.....	31
Menu 2 – Full Screen .....	31
Figure 73 - Menu 2 – Full Screen .....	31
Modbus.....	32
Table 18 – Modbus Table.....	32
Start-Up .....	34
Step 1 – Connect Main Power .....	34
Step 2 – Fill Coolant Circuit .....	34
System Fill Water Chemistry Requirements.....	34
Table 19 – Fill Water Chemistry Requirements.....	35
Table 20 - Recommended Glycol Solutions.....	36
Step 3 - Check Condenser .....	36
Water-Cooled Condenser Check.....	36
Remote Air-Cooled Condenser Check.....	36

Step 4 – Check Refrigerant Valves.....	36
Step 5 – Check Low Temperature Alarm.....	36
Step 6 – Turn On Control Power .....	36
Step 8 – Initial Unit Operation.....	37
Preventive Maintenance.....	37
Once a Week .....	37
Once a Month.....	38
Once Every 6 Months.....	38
Once a Year.....	38
Cleaning the Operator Interface.....	39
General Troubleshooting.....	40
Preventive Maintenance Checklist .....	41
Drawings.....	41

## Foreword

---

The central chiller consists of a refrigeration circuit to provide cooling water to coolant.

This manual is to serve as a guide for installing, operating, and maintaining the equipment. Improper installation, operation, and maintenance can lead to poor performance and/or equipment damage. Use qualified installers and service technicians for all installation and maintenance of this equipment.

This manual is for our standard product and is general in nature. Unit-specific drawings and supplemental documents are included with the equipment as needed. Additional copies of documents are available upon request.

Due to the ever-changing nature of applicable codes, ordinances, and other local laws pertaining to the use and operation of this equipment, we do not reference them in this manual.

The equipment uses a hydrofluorocarbon (HFC), trade named R-410A, or a hydrofluorolefin (HFO), trade named R-454B, as a chemical refrigerant for heat transfer purposes. R-454B is an A2L refrigerant, often referred to as "mildly flammable, and must be handled properly. No other refrigerant can be used in the system, nor can the refrigerants be mixed. This chemical is sealed and tested in a pressurized system containing ASME coded vessels; however, a system failure will release it. Refrigerant gas can cause toxic fumes if exposed to fire. Place these units in a well-ventilated area, especially if open flames are present. Failure to follow these instructions could result in a hazardous condition. We recommend the use of a refrigerant management program to document the type and quantity of refrigerant in the equipment. In addition, we recommend only licensed and EPA certified service technicians work on our refrigeration circuits.

## Safety Guidelines

---

Observe all safety precautions during installation, start-up, and service of this equipment. The following is a list of symbols used in this manual and their meaning.



*General Warning*



*Electricity Warning*



*Sharp Element Warning*



*Hot Surface Warning*



*Flammable Material Warning*



*Explosive Material Warning*



*General Mandatory Action*



*Wear Eye Protection*



*Wear Protective Gloves*



*Wear Ear Protection*



*Disconnect Before Carrying Out Maintenance or Repair*



*Connect an Earth Terminal to Ground*



Only qualified personnel should install, start-up, and service this equipment. When working on this equipment, observe precautions in this manual as well as tags, stickers, and labels on the equipment.



**WARNING:** Any use or misuse of this equipment outside of the design intent may cause injury or harm.



**WARNING:** Vent all refrigerant relief valves in accordance to ANSI/ASHRAE Standard 15, Safety Code for Mechanical Refrigeration. Locate this equipment in a well-ventilated area. Inhalation of refrigerant can be hazardous to your health and the accumulation of refrigerant within an enclosed space can displace oxygen and cause suffocation.



**WARNING:** This equipment contains hazardous voltages that can cause severe injury or death.



**WARNING:** This equipment contains refrigerant under pressure. Accidental release of refrigerant under pressure can cause personal injury and or property damage.



**WARNING:** This equipment may contain fan blades or other sharp edges. Make sure all fan guards and other protective shields are securely in place.



**WARNING:** The exposed surfaces of motors, refrigerant piping, and other fluid circuit components can be very hot and can cause burns if touched with unprotected hands.



**CAUTION:** Disconnect and lock out incoming power before installing, servicing, or maintaining the equipment. Connecting power to the main terminal block energizes the entire electric circuitry of the unit. Shut off the electric power at the main disconnect before opening access panels for repair or maintenance.



**CAUTION:** Wear eye protection when installing, maintaining, or repairing the equipment to protect against any sparks, debris, or fluid leaks.



**CAUTION:** The equipment will exceed 70 dBA sound pressure at 1 meter distance and 1 meter elevation when operating. Wear ear protection as required for personal comfort when operating or working in close proximity to the chiller.



**CAUTION:** Wear protective gloves when installing, maintaining, or repairing the equipment to protect against any sparks, debris, or fluid leaks.

## Pre-Installation

### Receiving Inspection

When the unit arrives, verify the information on the unit nameplate agrees with the order acknowledgement and shipping papers. Inspect the equipment for any visible damage and verify all items shown on the bill of lading are present. If damage is evident, document it on the delivery receipt by clearly marking any item with damage as "unit damage" and notify the carrier. In addition, notify our Customer Service Department and they will provide assistance with preparing and filing freight damage claims, including arranging for an estimate on repair costs; however, filing the shipping damage claim is the responsibility of the receiving party. Do not install damaged equipment without getting the equipment repaired.

Shipping damage is the responsibility of the carrier. To protect against possible loss due to damage incurred during shipping and to expedite payment for damages, it is important to follow proper procedures and keep records. Photographs of damaged equipment are excellent documentation for your records.

Start unpacking the unit, inspect for concealed damage, and take photos of any damage found. Once received, equipment owners have the responsibility to provide reasonable evidence that the damage did not occur after delivery. Photos of the equipment damage while the equipment is still partially packed will help in this regard. Refrigerant lines can be susceptible to damage in transit. Check for broken lines, oil leaks, damaged controls, or any other major component torn loose from its mounting point.

Record any signs of concealed damage and file a shipping damage claim immediately with the shipping company. Most carriers require concealed damages be reported within 15 days of receipt of the equipment. In addition, notify our Customer Service Department and they will provide assistance with preparing and filing freight damage claims, including arranging for an estimate on repair costs; however, filing the shipping damage claim is the responsibility of the receiving party.

A full refrigerant charge is included in chillers with an integral water-cooled condenser. Chillers designed for use with a remote air-cooled condenser and the remote condensers themselves ship with a nitrogen holding charge. Check the remote condenser for signs of leaks prior to rigging. This will ensure no coil damage has occurred after the unit left the factory. The condenser ships with the legs removed. Mount the legs to the condenser using the provided nuts, bolts, and washers.

### Unit Storage

When storing the unit it is important to protect it from damage. Blow out any water from the unit; cover it to keep dirt and debris from accumulating or getting in, and store in an indoor sheltered area that does not exceed 145°F.

## Installation - Chiller

---

### Foundation

Install the unit on a rigid, non-warping mounting pad, concrete foundation, or level floor suitable to support the full operating weight of the equipment. When installed the equipment must be level within ¼ inch over its length and width.

### Unit Location

The unit is available in many different configurations for various environments. Refer to the proposal and order acknowledgement document for the equipment to verify the specific design conditions in which it can operate.

To ensure proper airflow and clearance space for proper operation and maintenance allow a minimum of 36 inches of clearance between the sides of the equipment and any walls or obstructions. Avoid locating piping or conduit over the unit to ensure easy access with an overhead crane or lift to lift out heavier components during replacement or service. In addition, ensure the condenser and evaporator refrigerant pressure relief valves can vent in accordance with all local and national codes.

### Rigging

The chiller has a frame to facilitate easy movement and positioning with a crane or forklift. Follow proper rigging methods to prevent damage to components. Avoid impact loading caused by

sudden jerking when lifting or lowering the chiller. Use pads where abrasive surface contact may occur.

### Process Fluid Piping

Proper insulation of chilled process fluid piping is crucial to prevent condensation. The formation of condensation adds a substantial heat load to the chiller.

The importance of properly sized piping cannot be overemphasized. See the ASHRAE Handbook or other suitable design guide for proper pipe sizing. In general, run full size piping out to the process and reduce pipe size at connections as needed. One of the most common causes of unsatisfactory chiller performance is poor piping system design. Avoid long lengths of hoses, quick disconnect fittings, and manifolds wherever possible as they offer high resistance to water flow. When manifolds are required, install them as close to the use point as possible. Provide flow-balancing valves at each machine to assure adequate water distribution in the entire system.

### Condenser Water Piping

(Water-Cooled Condenser Units Only)

The performance of a water-cooled condenser is dependent on the flow and temperature of the cooling water used. Insufficient cooling of the condenser will result in the reduction of cooling capacity of the chiller and under extreme conditions may result in the chiller shutting down due to high refrigerant pressure. Allowing the condenser to plug up from contaminants in the condenser water stream adversely affects performance. In order to reduce maintenance costs and chiller downtime, a water treatment program is highly recommended for the condenser cooling water. Contact our Customer Service Department for assistance in the proper procedure for cleaning out any plugged condenser.

The nominal water-cooled condenser is design for 85°F condenser cooling water supply. Under normal operation there will be about a 10°F rise through the condenser resulting in 95°F exiting water. To ensure proper water flow through the condenser, ensure the condenser water pump provides at least 25 psi or water at a flow rate of 3 gpm per ton of chiller capacity.

Each condenser has a two-way condenser water-regulating valve. The condenser water-regulating valve controls the amount of water allowed to pass through the condenser in order to maintain proper refrigeration pressures in the circuit.

To prevent damage to the condenser and/or water-regulating valve, the water pressure should not exceed 150 psig.

## Water Pressure Gauges

Install pressure gauges in the inlet and outlet of both the condenser and evaporator chilled water piping to provide the ability to read the pressure drop across the chiller and aid in preventive maintenance and troubleshooting.



**WARNING:** Vent all refrigerant relief valves in accordance to ANSI/ASHRAE Standard 15, Safety Code for Mechanical Refrigeration. Locate this equipment in a well-ventilated area. Inhalation of refrigerant can be hazardous to your health and the accumulation of refrigerant within an enclosed space can displace oxygen and cause suffocation.



**WARNING:** This equipment contains hazardous voltages that can cause severe injury or death.



**WARNING:** This equipment contains refrigerant under pressure. Accidental release of refrigerant under pressure can cause personal injury and or property damage.



**WARNING:** This equipment may contain fan blades or other sharp edges. Make sure all fan guards and other protective shields are securely in place.



**WARNING:** The exposed surfaces of motors, refrigerant piping, and other fluid circuit components can be very hot and can cause burns if touched with unprotected hands.



**CAUTION:** Disconnect and lock out incoming power before installing, servicing, or maintaining the equipment. Connecting power to the main terminal block energizes the entire electric circuitry of the unit. A power supply provides 24 VDC control power. Shut off the electric power at the main disconnect before opening access panels for repair or maintenance.



**CAUTION:** Wear eye protection when installing, maintaining, or repairing the equipment to protect against any sparks, debris, or fluid leaks.



**CAUTION:** The equipment will exceed 70 dBA sound pressure at 1 meter distance and 1 meter elevation when operating. Wear ear protection as required for personal comfort when operating or working in close proximity to the chiller.



**CAUTION:** Wear protective gloves when installing, maintaining, or repairing the equipment to protect against any sparks, debris, or fluid leaks.

## System Temperature Sensor

This section only applies to installations where multiple chillers are in a common system where one chiller is the primary chiller with the other chillers serving as secondary chillers. In those situations, a field-installed fluid-temperature sensor is required in the common process fluid supply and return piping. Install the sensor downstream of all individual chilled water supply streams. Position the temperature sensor to read the mixed supply temperature. The supply temperature sensor is normally the control sensor for the chiller system set point and determines the loading/unloading of the compressors of the system.

The temperature sensor comes from the factory with a 1/2" NPT male fitting thermowell for direct mounting in the field piping. Mount the temperature sensor in a minimum pipe size of 3". Wire the temperature sensor to the designated primary chiller electrical enclosure and land at the appropriate terminal blocks within the enclosure. See the chiller electrical schematic for further details.

## Chiller Flow Sensor

This section only applies to installations when the flow sensor option is present. In those situations, a field-installed chiller flow sensor is required. Mount the flow sensor in the process fluid supply piping in an area of pipe with a minimum of 10 pipe diameters of straight run after any valves or pipefittings. This ensures the stream of fluid is solid and stable for accurate flow measurement.

The flow sensor comes from the factory with a 1/2" NPT compression fitting for direct mounting in the field piping. Mount the flow sensor in a minimum pipe size of 2". Insert the stem of the sensor into the compression fitting so the tip of the sensor is at the approximate center of the pipe. The sensor requires five pipe diameters of straight run piping on both sides of the sensor. Wire the flow sensor to the chiller electrical enclosure and land at the appropriate terminal blocks with the enclosure. See the chiller electrical schematic for further details.

## Installation - Remote Condenser

Chillers designed for use with a remote air-cooled condenser include a factory-selected remote condenser. The remote air-cooled condenser typically ships separately from a different location than the chiller.

### Location

The remote air-cooled condenser is for outdoor use. Locate the remote condenser in an accessible area. The vertical air discharge must be unobstructed.

When locating the condenser it is important to consider accessibility to the components to allow for proper maintenance and servicing of the unit. Avoid locating piping or conduit over the unit to ensure easy access with an overhead crane or lift to lift out heavier components during replacement or service.

Proper ventilation is another important consideration when locating the condenser. In general, locate the unit in an area that will not rise above 110°F.

Install the unit on a firm, level base no closer than its width from walls or other condensers. Avoid locations near exhaust fans, plumbing vents, flues, or chimneys. Fasten the mounting legs at their base to the steel or concrete of the supporting structure. For units mounted on a roof structure, the steel support base holding the condenser should be elevated above the roof and attached to the building.

Avoid areas that can create a “micro-climate” such as an alcove with east, north, and west walls that can be significantly warmer than surrounding areas. The condenser needs to have unrestricted airways so it can easily move cool air in and heated air away. Consider locating the condenser where fan noise and vibration transmission into nearby workspaces is unlikely.

Table 1 - Condenser Clearance Requirements

Nominal Cooling Capacity (ton)	From Ends (in)	From Sides (in)
10 to 80 single-circuit (flat coil)	48	48
100 single-circuit (V-coil)	36	63
120 single-circuit (V-coil)	36	80
20 to 160 ton dual-circuit (flat coil)	48	48
200 ton dual circuit (V-coil)	36	47
240 ton dual-circuit (V-coil)	36	62

The clearance requirements are to ensure proper airflow and to provide space for maintenance. Due to the nature of their design, the flat coil units require a minimum of 48 inches all around each condenser. If two condensers are side-by-side, the total clearance requirement is 96 inches. For the V-coil units, the 36-inch clearance at the ends is only for maintenance access, all of the air entered the coils from the sides. The clearances shown in the chart for the V-coils are for ground mounting; however, if the V-coil units are elevated 12 inches or more above the ground to allow airflow under the coils, they can be placed 12 inches apart. We recommend a minimum of 36 inch clear between V-coil units when elevated the 12 inches or more just to leave room for maintenance access.

### Flat Coil Condenser Foot Mounting

The 10 through 80-ton single-circuit and 20 through 160-ton dual-circuit condensers are a flat or horizontal coil design and ship on their sides with the legs removed to reduce shipping dimensions and provide more protection to the coil from possible damage caused by impact loading over rough roads and transit conditions.

Assemble the corner legs to the bottom flanges on the unit side panels and end panels using the hardware provided and the matching mounting hole-patterns. All corner legs are the same. For units that are longer than three fans, assemble the center leg. Remove two bolts from the bottom flange of the unit side panels that match the hole-pattern on the top flanges of both legs. Attached the center legs using the hardware provide at the center-divider panel location. Replace the bolts removed from the side panels to secure the leg assembly to the bottom flanges of the condenser side panels.

Figure 1 - Mounting Legs

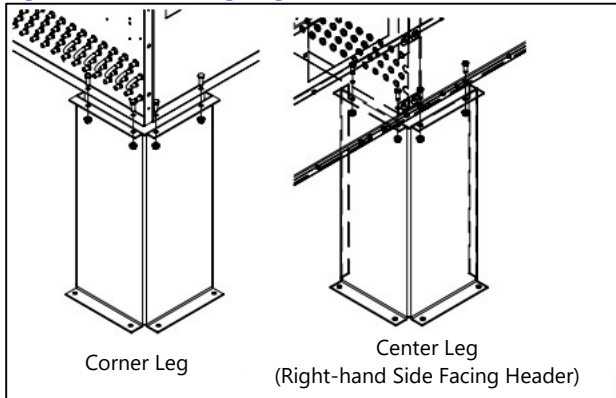

## Lifting

Use only qualified personnel using the proper equipment when lifting and positioning the condenser. Lift the remote condenser using the leg support channels or the side lifting brackets. Use spreader bars when lifting to apply the lifting force vertically. Under no circumstances use the coil headers or return bends in the lifting or moving of the condenser.

## Interconnecting Refrigerant Piping

The chiller and remote condenser ship with a nitrogen holding charge. Evacuation of this charge is required before charging with refrigerant. The chiller is for use only with the air-cooled condenser provided with the unit. The following section covers the required piping between the chiller and the provided air-cooled condenser.

The discharge and liquid lines leaving the chiller have caps. These line sizes do not necessarily reflect the actual line sizes required for the piping between the chiller and the air-cooled condenser.

Refrigerant piping size and piping design have a significant impact on system performance and reliability. All piping should conform to the applicable local and state codes.



**CAUTION:** Use refrigerant grade copper tubing ASTM B280 only and isolate the refrigeration lines from building structures to prevent transfer of vibration. All copper tubing must have a pressure rating suitable for R-410A: tubing that is 3/4" OD or larger must be Type K rigid tubing. ACR annealed tubing coil may be used for sizes 5/8" ODS or smaller.

Do not use a saw to remove end caps. This might allow copper chips to contaminate the system. Use a

tube cutter or heat to remove the caps. When sweating copper joints it is important to evacuate all refrigerant present and flow dry nitrogen through the system. This prevents the formation of toxic gases, corrosive acids, and scale.



**CAUTION:** Do not use soft solders. For copper-to-copper joints use a copper-phosphorus braze alloy (BCuP per the American Welding Society) with 5% (BCuP-3) to 15% (BCuP-5) silver content. Only use a high silver content brazing alloy (BAg per AWS) for copper-to-brass or copper-to-steel joints such as a 45% (BAg-5) silver content. Only use oxy-acetylene brazing.



**WARNING:** The POE oil contained within the compressor is hygroscopic and has the ability to absorb water vapor from the atmosphere. Take necessary steps to prevent an open system from exposure to the atmosphere for extended periods while installing the interconnecting refrigerant tubing.

## Refrigeration Piping Design

The system is configurable in any of the arrangements as shown in Figure 2, Figure 3, and Figure 4. The configuration and its associated elevation, along with the total distance between the chiller and the air-cooled condenser are important factors in determining the liquid line and discharge line sizes. This will also affect the field refrigerant charges. Consequently, it is important to adhere to certain physical limitations to ensure the system operates as designed.

### General design considerations are:

1. The total distance between the chiller and the air-cooled condenser must not exceed 200 actual feet or 300 equivalent feet. Keep the distance as short as possible.
2. Liquid line risers must not exceed 15 feet in height from the condenser liquid line connection.
3. Discharge line risers cannot exceed an elevation difference greater than 100 actual feet without a minimum of 2% efficiency decrease.
4. To form a proper liquid seal at the condenser, immediately drop at least 15 inches down from the liquid outlet before routing the piping to the chiller. Make the drop leg before any bends or angles connecting to the remainder of the liquid connection piping.
5. Pipe condensers with dual circuits to assure equal refrigerant flow to each circuit.

Figure 2 – Condenser Located at Chiller Level

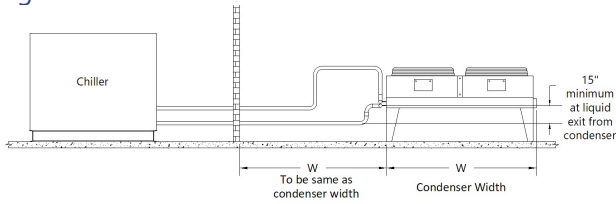

Figure 3 – Condenser Located Below Chiller Unit

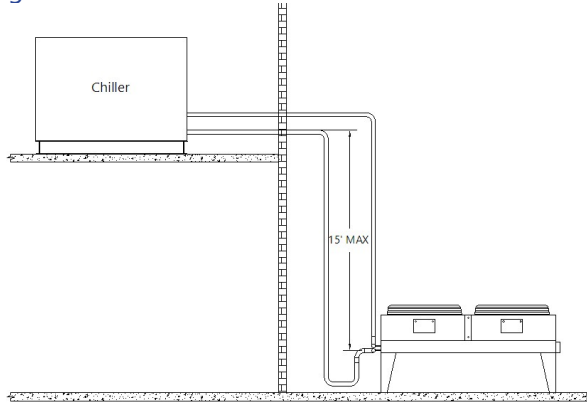
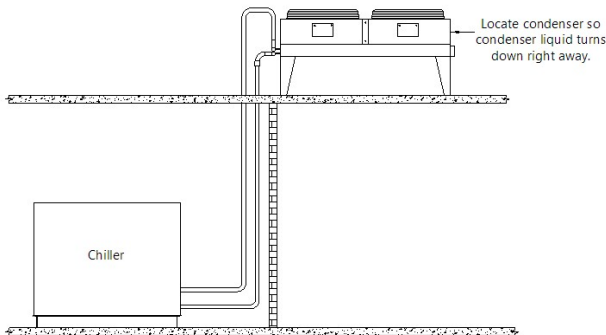

Figure 4 - Condenser Located Above Chiller Unit



Caution: Liquid line sizing for each chiller capacity is in Table . These line sizes are listed per circuit and apply where leaving water temperature (LWT) is 40°F or higher. For applications where the LWT is below 40°F, size lines using the ASHRAE Refrigeration Handbook or other suitable design guide.

### Determining Equivalent Line Length

To determine the appropriate size for field installed liquid and discharge lines, it is first necessary to establish the equivalent length of pipe for each line. The equivalent length is the approximate friction loss from the combined linear run of pipe and the equivalent feet of elbows, valves, and other components in the refrigeration piping. The sum total is the equivalent length of pipe that would have the same pressure loss. See the ASHRAE Refrigeration Handbook for more information.

Follow these steps when calculating line size:

1. Start with an initial approximation of equivalent length by assuming that the equivalent length of pipe is 1.5 times the actual pipe length.
2. Determine approximate line sizes by referring to Table 3 for liquid lines, Table 4 and Table 5 for the discharge lines.
3. Check the line size by calculating the actual equivalent length using the equivalent lengths as shown in Table 2.



CAUTION: When calculating the equivalent length, do not include piping of the chiller unit. Only field piping must be considered.

Table 2 – Equivalent Lengths of Elbows

Line Size OD (in)	Equivalent Lengths of Refrigerant Pipe (feet)				
	90° Standard	90° Long Radius	90° Street	45° Standard	45° Street
7/8	2.0	1.4	3.2	0.9	1.6
1 1/8	2.6	1.7	4.1	1.3	2.1
1 3/8	3.3	2.3	5.6	1.7	3.0
1 5/8	4.0	2.6	6.3	2.1	3.4
2 1/8	5.0	3.3	8.2	2.6	4.5
2 5/8	6.0	4.1	10.0	3.2	5.2
3 1/8	7.5	5.0	12.0	4.0	6.4
3 5/8	9.0	5.9	15.0	4.7	7.3
4 1/8	10.0	6.7	17.0	5.2	8.5

### Liquid Line Sizing

The liquid line diameter should be as small as possible while maintaining acceptable pressure drop. This is necessary to minimize refrigerant charge. The total length between the chiller unit and the air-cooled condenser must not exceed 200 actual feet or 300 equivalent feet. It is best to pipe the liquid line so that there is an immediate drop of at least 15 inches at the condenser outlets to make a liquid seal.

Liquid line risers in the system will require an additional 0.5 psig pressure drop per foot of vertical rise. When it is necessary to have a liquid line riser, make the vertical run immediately after the condenser before any additional restrictions. The liquid line risers must not exceed 10 feet in height from the condenser liquid line connection. The liquid line does not require pitching. Install a pressure tap valve at the condenser to facilitate measuring pressure for service.

Liquid lines do not typically require insulation. However, if exposing the lines to solar heat gain or temperatures exceeding 110 °F, there is a negative

effect on sub-cooling. In these situations, insulate the liquid lines.

Table 3 – Liquid Line Sizes for R410A and R454B

10 Ton Circuit Liquid Line Size (Inch OD)					15 Ton Circuit Liquid Line Size (Inch OD)				
Equivalent Length (Ft)	Horizontal or Down Flow	Up Flow (Feet of Run)			Equivalent Length (Ft)	Horizontal or Down Flow	Up Flow (Feet of Run)		
		0 to 5	6 to 10	11 to 15			0 to 5	6 to 10	11 to 15
25	3/4	3/4	3/4	3/4	25	7/8	7/8	7/8	7/8
50	3/4	3/4	3/4	3/4	50	7/8	7/8	7/8	7/8
75	3/4	3/4	3/4	3/4	75	7/8	7/8	7/8	7/8
100	3/4	3/4	3/4	7/8	100	7/8	7/8	7/8	1 1/8
125	3/4	3/4	3/4	7/8	125	7/8	7/8	7/8	1 1/8
150	3/4	3/4	3/4	7/8	150	7/8	7/8	7/8	1 1/8
175	3/4	3/4	3/4	7/8	175	7/8	7/8	7/8	1 1/8
200	3/4	3/4	7/8	1 1/8	200	7/8	7/8	1 1/8	1 1/8
225	3/4	3/4	7/8	1 1/8	225	7/8	7/8	1 1/8	1 1/8
250	3/4	3/4	7/8	1 1/8	250	7/8	7/8	1 1/8	1 1/8
275	3/4	3/4	7/8	1 1/8	275	7/8	7/8	1 1/8	1 1/8
300	3/4	7/8	7/8	1 1/8	300	7/8	7/8	1 1/8	1 1/8
20 Ton Circuit Liquid Line Size (Inch OD)					25 Ton Circuit Liquid Line Size (Inch OD)				
Equivalent Length (Ft)	Horizontal or Down Flow	Up Flow (Feet of Run)			Equivalent Length (Ft)	Horizontal or Down Flow	Up Flow (Feet of Run)		
		0 to 5	6 to 10	11 to 15			0 to 5	6 to 10	11 to 15
25	1 1/8	1 1/8	1 1/8	1 1/8	25	1 1/8	1 1/8	1 1/8	1 1/8
50	1 1/8	1 1/8	1 1/8	1 1/8	50	1 1/8	1 1/8	1 1/8	1 1/8
75	1 1/8	1 1/8	1 1/8	1 1/8	75	1 1/8	1 1/8	1 1/8	1 1/8
100	1 1/8	1 1/8	1 1/8	1 1/8	100	1 1/8	1 1/8	1 1/8	1 1/8
125	1 1/8	1 1/8	1 1/8	1 1/8	125	1 1/8	1 1/8	1 1/8	1 1/8
150	1 1/8	1 1/8	1 1/8	1 1/8	150	1 1/8	1 1/8	1 1/8	1 3/8
175	1 1/8	1 1/8	1 1/8	1 1/8	175	1 1/8	1 1/8	1 1/8	1 3/8
200	1 1/8	1 1/8	1 1/8	1 3/8	200	1 1/8	1 1/8	1 1/8	1 3/8
225	1 1/8	1 1/8	1 1/8	1 3/8	225	1 1/8	1 1/8	1 1/8	1 3/8
250	1 1/8	1 1/8	1 1/8	1 3/8	250	1 1/8	1 1/8	1 1/8	1 3/8
275	1 1/8	1 1/8	1 1/8	1 3/8	275	1 1/8	1 1/8	1 1/8	1 3/8
300	1 1/8	1 1/8	1 1/8	1 3/8	300	1 1/8	1 1/8	1 3/8	1 3/8

Table 3 – Liquid Line Sizes for R410A and R454B (continued)

30 Ton Circuit Liquid Line Size (Inch OD)					40 Ton Circuit Liquid Line Size (Inch OD)				
Equivalent Length (Ft)	Horizontal or Down Flow	Up Flow (Feet of Run)			Equivalent Length (Ft)	Horizontal or Down Flow	Up Flow (Feet of Run)		
		0 to 5	6 to 10	11 to 15			0 to 5	6 to 10	11 to 15
25	1 1/8	1 1/8	1 1/8	1 1/8	25	1 3/8	1 3/8	1 3/8	1 3/8
50	1 1/8	1 1/8	1 1/8	1 1/8	50	1 3/8	1 3/8	1 3/8	1 3/8
75	1 1/8	1 1/8	1 1/8	1 1/8	75	1 3/8	1 3/8	1 3/8	1 3/8
100	1 1/8	1 1/8	1 1/8	1 3/8	100	1 3/8	1 3/8	1 3/8	1 3/8
125	1 1/8	1 1/8	1 1/8	1 3/8	125	1 3/8	1 3/8	1 3/8	1 3/8
150	1 1/8	1 1/8	1 1/8	1 3/8	150	1 3/8	1 3/8	1 3/8	1 5/8
175	1 1/8	1 1/8	1 1/8	1 3/8	175	1 3/8	1 3/8	1 3/8	1 5/8
200	1 1/8	1 1/8	1 1/8	1 3/8	200	1 3/8	1 3/8	1 3/8	1 5/8
225	1 1/8	1 1/8	1 3/8	1 3/8	225	1 3/8	1 3/8	1 3/8	1 5/8
250	1 1/8	1 1/8	1 3/8	1 5/8	250	1 3/8	1 3/8	1 3/8	1 5/8
275	1 1/8	1 1/8	1 3/8	1 5/8	275	1 3/8	1 3/8	1 3/8	1 5/8
300	1 1/8	1 1/8	1 3/8	1 5/8	300	1 3/8	1 3/8	1 3/8	1 5/8
50 Ton Circuit Liquid Line Size (Inch OD)					60 Ton Circuit Liquid Line Size (Inch OD)				
Equivalent Length (Ft)	Horizontal or Down Flow	Up Flow (Feet of Run)			Equivalent Length (Ft)	Horizontal or Down Flow	Up Flow (Feet of Run)		
		0 to 5	6 to 10	11 to 15			0 to 5	6 to 10	11 to 15
25	1 3/8	1 3/8	1 3/8	1 3/8	25	1 5/8	1 5/8	1 5/8	1 5/8
50	1 3/8	1 3/8	1 3/8	1 3/8	50	1 5/8	1 5/8	1 5/8	1 5/8
75	1 3/8	1 3/8	1 3/8	1 3/8	75	1 5/8	1 5/8	1 5/8	1 5/8
100	1 3/8	1 3/8	1 3/8	1 5/8	100	1 5/8	1 5/8	1 5/8	1 5/8
125	1 3/8	1 3/8	1 3/8	1 5/8	125	1 5/8	1 5/8	1 5/8	1 5/8
150	1 3/8	1 3/8	1 3/8	1 5/8	150	1 5/8	1 5/8	1 5/8	1 5/8
175	1 3/8	1 3/8	1 3/8	1 5/8	175	1 5/8	1 5/8	1 5/8	2 1/8
200	1 3/8	1 3/8	1 3/8	1 5/8	200	1 5/8	1 5/8	1 5/8	2 1/8
225	1 3/8	1 3/8	1 5/8	1 5/8	225	1 5/8	1 5/8	1 5/8	2 1/8
250	1 3/8	1 3/8	1 5/8	2 1/8	250	1 5/8	1 5/8	1 5/8	2 1/8
275	1 3/8	1 3/8	1 5/8	2 1/8	275	1 5/8	1 5/8	1 5/8	2 1/8
300	1 3/8	1 3/8	1 5/8	2 1/8	300	1 5/8	1 5/8	1 5/8	2 1/8



Table 3 – Liquid Line Sizes for R410A and R454B (continued)

80 Ton Circuit Liquid Line Size (Inch OD)					100 Ton Circuit Liquid Line Size (Inch OD)				
Equivalent Length (Ft)	Horizontal or Down Flow	Up Flow (Feet of Run)			Equivalent Length (Ft)	Horizontal or Down Flow	Up Flow (Feet of Run)		
		0 to 5	6 to 10	11 to 15			0 to 5	6 to 10	11 to 15
25	2 1/8	2 1/8	2 1/8	2 1/8	25	2 1/8	2 1/8	2 1/8	2 1/8
50	2 1/8	2 1/8	2 1/8	2 1/8	50	2 1/8	2 1/8	2 1/8	2 1/8
75	2 1/8	2 1/8	2 1/8	2 1/8	75	2 1/8	2 1/8	2 1/8	2 1/8
100	2 1/8	2 1/8	2 1/8	2 1/8	100	2 1/8	2 1/8	2 1/8	2 1/8
125	2 1/8	2 1/8	2 1/8	2 1/8	125	2 1/8	2 1/8	2 1/8	2 1/8
150	2 1/8	2 1/8	2 1/8	2 1/8	150	2 1/8	2 1/8	2 1/8	2 1/8
175	2 1/8	2 1/8	2 1/8	2 1/8	175	2 1/8	2 1/8	2 1/8	2 1/8
200	2 1/8	2 1/8	2 1/8	2 1/8	200	2 1/8	2 1/8	2 1/8	2 1/8
225	2 1/8	2 1/8	2 1/8	2 1/8	225	2 1/8	2 1/8	2 1/8	2 1/8
250	2 1/8	2 1/8	2 1/8	2 1/8	250	2 1/8	2 1/8	2 1/8	2 5/8
275	2 1/8	2 1/8	2 1/8	2 1/8	275	2 1/8	2 1/8	2 1/8	2 5/8
300	2 1/8	2 1/8	2 1/8	2 1/8	300	2 1/8	2 1/8	2 1/8	2 5/8
120 Ton Circuit Liquid Line Size (Inch OD)									
Equivalent Length (Ft)	Horizontal or Down Flow	Up Flow (Feet of Run)							
		0 to 5	6 to 10	11 to 15					
25	2 1/8	2 1/8	2 1/8	2 1/8					
50	2 1/8	2 1/8	2 1/8	2 1/8					
75	2 1/8	2 1/8	2 1/8	2 1/8					
100	2 1/8	2 1/8	2 1/8	2 1/8					
125	2 1/8	2 1/8	2 1/8	2 1/8					
150	2 1/8	2 1/8	2 1/8	2 1/8					
175	2 1/8	2 1/8	2 1/8	2 5/8					
200	2 1/8	2 1/8	2 1/8	2 5/8					
225	2 1/8	2 1/8	2 1/8	2 5/8					
250	2 1/8	2 1/8	2 1/8	2 5/8					
275	2 1/8	2 1/8	2 1/8	2 5/8					
300	2 1/8	2 1/8	2 1/8	2 5/8					

## Discharge (Hot Gas) Line Sizing

The discharge line sizes depend on the velocity needed to obtain sufficient oil return. It is very important to minimize line length and restrictions to reduce pressure drop and maximize capacity.

Upflow hot gas risers need to have a trap at the bottom and reverse trap at the top. In addition, a trap and reverse trap arrangement needs to be spaced every 15 feet in the rise for oil management (see Figure 5).

The discharge lines should pitch downward, in the direction of the hot gas flow, at the rate of 1/2 inch per each 10 foot of horizontal run. If the chiller unit is below the condenser, loop the discharge line to at least 1 inch above the top of the condenser. Install a pressure tap valve at the condenser to facilitate measuring pressure for service. Take careful consideration in the design of the discharge gas riser.

Check the oil-level sight glass in the compressor to ensure it is at the appropriate level to verify there is no trapping of oil in the piping. Use a double riser system to ensure proper oil return. See Figure 6 and Table for double riser constructions.

Figure 5 – Vertical Riser Traps

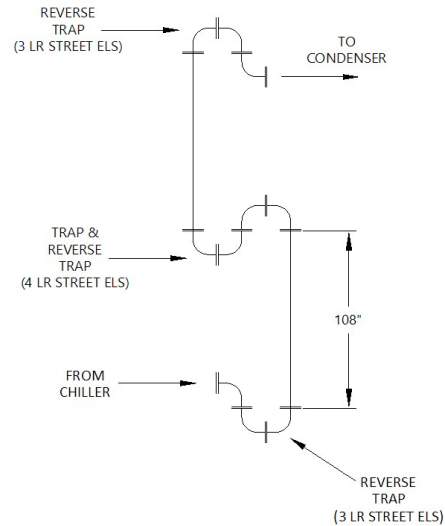
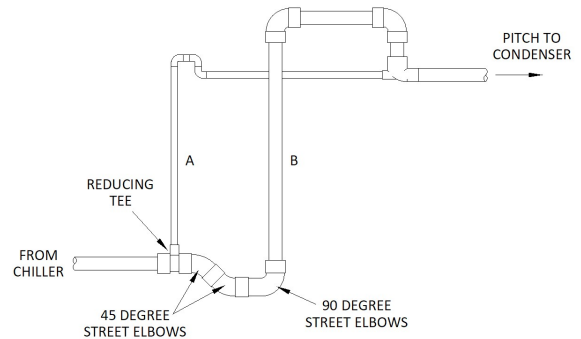

Figure 6 - Double Discharge Riser



Note: Discharge line sizing shown in Table 4 and Table 5 are listed per circuit and applies where leaving water temperature (LWT) is 40°F or higher. For applications where LWT is below 40°F, size lines using the ASHRAE Refrigeration Handbook or other suitable design guide.

Table 4 - Horizontal or Downflow Discharge Line Sizes for R410A and R454B (inches OD)

Circuit Tons	Total Equivalent Length (Ft)											
	25	50	75	100	125	150	175	200	225	250	275	300
10	7/8	7/8	7/8	7/8	7/8	7/8	7/8	1 1/8	1 1/8	1 1/8	1 1/8	1 1/8
15	7/8	7/8	1 1/8	1 1/8	1 1/8	1 1/8	1 1/8	1 1/8	1 1/8	1 1/8	1 3/8	1 3/8
20	7/8	1 1/8	1 1/8	1 3/8	1 3/8	1 3/8	1 3/8	1 3/8	1 3/8	1 3/8	1 5/8	1 5/8
25	1 1/8	1 1/8	1 1/8	1 1/8	1 3/8	1 3/8	1 3/8	1 3/8	1 3/8	1 3/8	1 5/8	1 5/8
30	1 1/8	1 1/8	1 1/8	1 3/8	1 3/8	1 3/8	1 3/8	1 3/8	1 3/8	1 5/8	1 5/8	1 5/8
40	1 5/8	1 5/8	1 5/8	1 5/8	1 5/8	1 5/8	2 1/8	2 1/8	2 1/8	2 1/8	2 1/8	2 1/8
50	1 5/8	1 5/8	1 5/8	1 5/8	1 5/8	2 1/8	2 1/8	2 1/8	2 1/8	2 1/8	2 1/8	2 1/8
60	1 5/8	1 5/8	1 5/8	2 1/8	2 1/8	2 1/8	2 1/8	2 1/8	2 1/8	2 1/8	2 1/8	2 1/8
80	1 5/8	1 5/8	2 1/8	2 1/8	2 1/8	2 1/8	2 1/8	2 1/8	2 5/8	2 5/8	2 5/8	2 5/8
100	2 1/8	2 1/8	2 1/8	2 1/8	2 1/8	2 5/8	2 5/8	2 5/8	2 5/8	2 5/8	2 5/8	2 5/8
120	2 1/8	2 1/8	2 5/8	2 5/8	2 5/8	2 5/8	2 5/8	2 5/8	3 1/8	3 1/8	3 1/8	3 1/8

Table 5 - Upflow Discharge Line Sizes for R410A and R454B (inches OD)

Circuit Tons	Total Equivalent Length (Ft)											
	25	50	75	100	125	150	175	200	225	250	275	300
10	A - 3/8	A - 3/8	A - 3/8	A - 3/8	A - 3/8	A - 3/8	A - 3/8	A - 3/8	A - 3/8	A - 3/8	A - 3/8	A - 3/8
	B - 3/4	B - 3/4	B - 3/4	B - 3/4	B - 3/4	B - 3/4	B - 3/4	B - 3/4	B - 7/8	B - 7/8	B - 7/8	B - 7/8
15	A - 3/8	A - 3/8	A - 3/8	A - 3/8	A - 3/8	A - 3/8	A - 3/8	A - 3/8	A - 3/8	A - 3/8	A - 1/2	A - 1/2
	B - 3/4	B - 3/4	B - 7/8	B - 7/8	B - 7/8	B - 7/8	B - 7/8	B - 7/8	B - 7/8	B - 7/8	B - 1 1/8	B - 1 1/8
20	A - 3/8	A - 3/8	A - 3/8	A - 1/2	A - 1/2	A - 1/2	A - 1/2	A - 1/2	A - 1/2	A - 1/2	A - 5/8	A - 5/8
	B - 3/4	B - 7/8	B - 7/8	B - 1 1/8	B - 1 1/8	B - 1 1/8	B - 1 1/8	B - 1 1/8	B - 1 1/8	B - 1 1/8	B - 1 3/8	B - 1 3/8
25	A - 3/8	A - 3/8	A - 3/8	A - 1/2	A - 1/2	A - 1/2	A - 1/2	A - 1/2	A - 1/2	A - 1/2	A - 5/8	A - 5/8
	B - 7/8	B - 7/8	B - 7/8	B - 1 1/8	B - 1 1/8	B - 1 1/8	B - 1 1/8	B - 1 1/8	B - 1 1/8	B - 1 1/8	B - 1 3/8	B - 1 3/8
30	A - 1/2	A - 1/2	A - 1/2	A - 3/4	A - 3/4	A - 3/4	A - 3/4	A - 3/4	A - 3/4	A - 3/4	A - 3/4	A - 3/4
	B - 7/8	B - 7/8	B - 7/8	B - 1 1/8	B - 1 1/8	B - 1 1/8	B - 1 1/8	B - 1 1/8	B - 1 1/8	B - 1 3/8	B - 1 3/8	B - 1 3/8
40	A - 3/4	A - 3/4	A - 3/4	A - 3/4	A - 3/4	A - 3/4	A - 3/4	A - 3/4	A - 3/4	A - 3/4	A - 3/4	A - 3/4
	B - 1 3/8	B - 1 3/8	B - 1 3/8	B - 1 3/8	B - 1 3/8	B - 1 3/8	B - 1 3/8	B - 1 5/8	B - 1 5/8	B - 1 5/8	B - 1 5/8	B - 1 5/8
50	A - 3/4	A - 3/4	A - 3/4	A - 3/4	A - 3/4	A - 3/4	A - 3/4	A - 3/4	A - 3/4	A - 3/4	A - 3/4	A - 3/4
	B - 1 3/8	B - 1 3/8	B - 1 3/8	B - 1 3/8	B - 1 3/8	B - 1 5/8	B - 1 5/8	B - 1 5/8	B - 1 5/8	B - 1 5/8	B - 1 5/8	B - 1 5/8
60	A - 3/4	A - 3/4	A - 7/8	A - 7/8	A - 7/8	A - 7/8	A - 7/8	A - 7/8	A - 7/8	A - 7/8	A - 7/8	A - 7/8
	B - 1 3/8	B - 1 3/8	B - 1 5/8	B - 1 5/8	B - 1 5/8	B - 1 5/8	B - 1 5/8	B - 1 5/8	B - 1 5/8	B - 1 5/8	B - 1 5/8	B - 1 5/8
80	A - 3/4	A - 3/4	A - 7/8	A - 7/8	A - 7/8	A - 7/8	A - 7/8	A - 7/8	A - 7/8	A - 7/8	A - 7/8	A - 7/8
	B - 1 3/8	B - 1 3/8	B - 1 5/8	B - 1 5/8	B - 1 5/8	B - 1 5/8	B - 1 5/8	B - 1 5/8	B - 2 1/8	B - 2 1/8	B - 2 1/8	B - 2 1/8
100	A - 1 1/8	A - 1 1/8	A - 1 1/8	A - 1 3/8	A - 1 3/8	A - 1 3/8	A - 1 3/8	A - 1 3/8	A - 1 3/8	A - 1 5/8	A - 1 5/8	A - 1 5/8
	B - 2 1/8	B - 2 1/8	B - 2 1/8	B - 2 1/8	B - 2 5/8	B - 2 5/8	B - 2 5/8	B - 2 5/8	B - 2 5/8	B - 2 1/8	B - 2 1/8	B - 2 1/8
120	A - 1 1/8	A - 1 1/8	A - 1 1/8	A - 1 3/8	A - 1 3/8	A - 1 3/8	A - 1 3/8	A - 1 3/8	A - 1 3/8	A - 1 5/8	A - 1 5/8	A - 1 5/8
	B - 1 5/8	B - 1 5/8	B - 2 1/8	B - 2 5/8	B - 2 5/8	B - 2 5/8	B - 2 5/8	B - 2 5/8	B - 2 5/8	B - 2 5/8	B - 2 5/8	B - 2 5/8

### Calculating Refrigerant and Oil Charge

To determine the approximate charge, first refer to Table 6 and establish the required charge for the condenser and chiller. Then refer to Table 7 to determine the charge required for the field-installed piping per circuit. The approximate charge per circuit is therefore the sum of the values from Table 6 and Table 7.

The charge required for an air-cooled condenser using fan cycling and variable speed for head pressure control is indeterminate due to site and environmental variances. Because refrigerant density increases with decreasing temperatures, the low ambient operating charge is more (compared to the summer charge). In the worst case of -20°F, the charge may nearly double. The best way to assure proper charging is, on the coldest day of the year under full load, the charge should be up to the second sight glass from the bottom of the receiver

with the electric expansion valve (EXV) sight glass clear. Prolonged periods of foaming in the sight glass may indicate a low refrigerant condition or a restriction in the liquid line.

*Note: Occasional bubbling in a sight glass may occur at a time when load conditions are changing and the expansion valve is adjusting to the new conditions. This momentary occurrence is a result of normal chiller operation.*

Use the sight glass to check if there is moisture in the refrigeration circuit. If there is moisture in the circuit, the green ring around the perimeter of the sight glass will turn yellow. If this occurs, service immediately.

Table 6 – Chiller and Condenser Refrigerant Charge

Circuit Capacity (tons)	Total Combined Chiller and Condenser Summertime Refrigerant Charge (pounds per circuit)	
	(Lbs. of R-410A @ 60°F)	(Lbs. of R454B @ 60°F)
10	17.3	16.1
15	24.7	23.0
20	30.2	28.1
25	37.2	34.5
30	44.3	41.1
40	59.4	55.1
50	79.6	73.9
60	109.0	101.1
80	136.1	126.3
100	125.2	116.1
120	151.2	140.3

Table 7 - Field Piping Refrigerant Charges

Line Size OD (inches)	Discharge Line (Lbs./100' run)		Liquid Line (Lbs./100' run)	
	R-410A	R-454B	R-410A	R-454B
3/8	0.4	0.4	3.7	3.5
1/2	0.7	0.6	6.8	6.4
5/8	1.1	0.9	11	10.3
3/4	1.6	1.3	16.4	15.4
7/8	2.2	1.7	22.8	21.3
1 1/8	3.6	2.8	36.7	34.3
1 3/8	5.6	4.2	57.4	53.6
1 5/8	7.9	6.0	81.2	75.8
2 1/8	13.9	10.5	142.1	132.6
2 5/8	21.4	16.2	219.5	204.9

### Oil Charge Determination

The chiller is factory charged with the amount of oil required by the chiller only and not the total system. The amount of oil required is dependent upon the amount of refrigerant added to the system for the field-installed piping. Use the following to determine the amount of oil needed for the system.

$$\text{Pints of Oil} = \text{Pounds of refrigerant in system} / 100$$

Check oil level after the chiller has run for 15 minutes.

## Installation - Electrical

All wiring must comply with local codes and the National Electric Code. Minimum circuit amps (MCA) and other unit electrical data are on the unit nameplate. A unit specific electrical schematic ships with the unit. Measure each leg of the main power supply voltage at the main power source. Voltage must be within the voltage utilization range given on the drawings included with the unit. If the measured voltage on any leg is not within the specified range, notify the supplier and correct before operating the unit. Voltage imbalance must not exceed two percent. Excessive voltage imbalance between the phases of a three-phase system can cause motors to overheat and eventually fail. Voltage imbalance is determined using the following calculations.

$$\% \text{ Imbalance} = (\text{Vavg} - \text{Vx}) \times 100 / \text{Vavg}$$

$$\text{Vavg} = (\text{V1} + \text{V2} + \text{V3}) / 3$$

Vx = phase with greatest difference from Vavg

For example, if the three measured voltages were 442, 460, and 454 volts, the average would be:

$$(442 + 460 + 454) / 3 = 452$$

The percentage of imbalance is then:

$$(452 - 442) \times 100 / 452 = 2.2 \%$$

This exceeds the maximum allowable of 2%.

There is a terminal block for main power connection to the main power source. The main power source should be connected to the terminal block through an appropriate disconnect switch. There is a separate lug in the main control panel for grounding the unit. Check the electrical phase sequence at installation and prior to start-up. Operation of the compressor with incorrect electrical phase sequencing will result in mechanical damage to the compressors. Check the phasing with a phase sequence meter prior to applying power. The proper sequence should read "ABC" on the meter. If the meter reads "CBA", open the main power disconnect and switch two line leads on the line power terminal blocks (or the unit mounted disconnect). Do not interchange any load leads that are from the unit contactors or the motor terminals.



*WARNING: This equipment contains hazardous voltages that can cause severe injury or death.*



*WARNING: This equipment contains refrigerant under pressure. Accidental release of refrigerant under pressure can cause personal injury and or property damage.*



*WARNING: This equipment may contain fan blades or other sharp edges. Make sure all fan guards and other protective shields are securely in place.*



*WARNING: The exposed surfaces of motors, refrigerant piping, and other fluid circuit components can be very hot and can cause burns if touched with unprotected hands.*



*CAUTION: Disconnect and lock out incoming power before installing, servicing, or maintaining the equipment. Connecting power to the main terminal block energizes the entire electric circuitry of the unit. Electric power at the main disconnect should be shut off before opening access panels for repair or maintenance.*



*CAUTION: Wear eye protection when installing, maintaining, or repairing the equipment to protect against any sparks, debris, or fluid leaks.*



*CAUTION: Wear protective gloves when installing, maintaining, or repairing the equipment to protect against any sparks, debris, or fluid leaks.*



*CAUTION: Wire the unit ground in compliance with local and national codes.*



*CAUTION: The unit requires the main power to remain connected during off-hours to energize the compressor's crankcase heater. Disconnect main power only when servicing the chiller. The crankcase heater should remain on when the compressor is off to ensure liquid refrigerant does not accumulate in the compressor crankcase. Connect main power at least 24 hours prior to initial startup.*

## Control Operation

The units uses a Programmable Logic Controller (PLC) and color touch-screen operator interface display that serves as the Human to Machine Interface (HMI).

### Screen Navigation

The overall menus structure allows for quick access and navigation to each section of the control monitoring and control system. The following are the main buttons used to navigate through the various screens.



**Menu Button** – This button is located on the top left of the screen. Touch this button to go to Menu 1.



**Home Button** – This button is located on the bottom of the screen. Touch this button to go to the Home Overview Screen.



**Alarm Button** – This button is located on the bottom of the screen. This button shows the number of alarms active. Touch this button to go to the HMI Alarm Handler Screen.



**Alarm Reset Button** – This button is located on the bottom of the screen. Touch this button to acknowledge and silence active alarms.



**Start/Stop Button** – This button is located at the bottom right of the screen. Touch this button to start and stop the chiller. When stopped, the button outline is red, when running the button outline is green.



**Arrow Button** – These buttons appear in multiple areas of the screen. Touch these buttons to navigate forward, back, up or down in menus and screens.

Some screens are password protected to prevent unintended changes. There are two levels of security (*Username is case sensitive*):

“User” Level Password = 9999

“Supervisor” Level Password = 7720

When navigating screens any user adjustable areas appear in a slightly different color. Touching one of these areas brings up a keypad. Use the keypad to enter the appropriate user and password to gain access.

The user-level password allows access to the most common functions; however, there are a few screens protected with a Supervisor-level password. Changing items in Supervisor-level menus without fully understanding the impact can lead to improper or poor performance of the unit. Contact our Customer Service department for assistance with any questions before making changes.

There is a reset function to restore the factory default settings. When this is done follow the on-screen prompts to reconfigure the chiller based on the options present. For assistance with this process, please contact our Customer Service Department and have the unit Serial Number ready for reference.

### System Initialization

Upon power-up, the first screen to appear is the Start-Up Screen as shown in Figure 7. This screen will display while the Programmable Logic Controller (PLC) and Human Machine Interface (HMI) establish communications. The PLC/HMI version shows on the screen.

Figure 7 – Start-Up Splash Screen

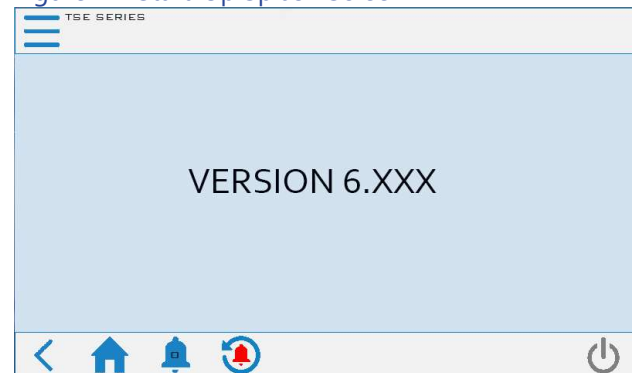

Once control communication is established, the HMI screen automatically switches to the Home Screen.

# Home – Chiller Home Screen

## System Overview

This screen provides an overall synopsis of the chiller system, quick links to other views, as well as other additional information.

Figure 8 – Chiller Home Screen

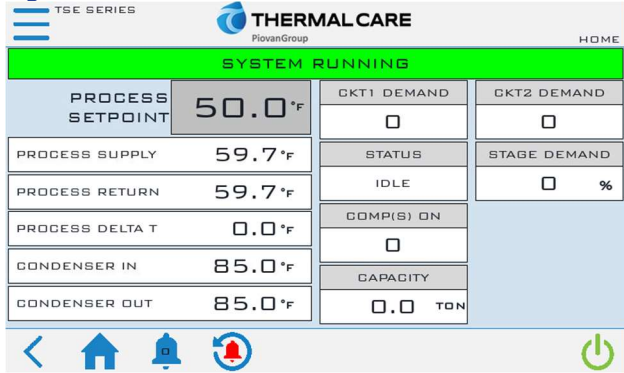

Note: This is an example of a chiller with the most extensive set of options; your screen may appear slightly different based on your actual chiller configuration.

Table 8 – System Overview Functions

Function	Description	Screen Reference	
CKT Demand	Informs the operator of the compressors in operation in each circuit	None	
Status Messaging	Provides information about any warnings or alarms which may have occurred.	None	
Setpoint	Modify the Setpoint by touching the current Setpoint on the HMI. An authorized security level password is required to enter a new Setpoint.	None	
Menu Button	Changes to the Menu 1 screen	Figure 11	
		N/A	
Alarms	A listing of active and prior alarm history. The number displayed on the bell indicates the number of active alarms.	Figure 13 Figure 14	
		N/A	
Alarm(s) Reset	Will both silence and reset any alarms	None	
		N/A	
Start / Stop	Pressing the Start button will provide the ability to start or stop the chiller as well as any other networked chillers attached to this system.	Figure 9 Figure 10	
	System Off		N/A
	System Running		N/A

## Starting and Stopping the Chiller

### Starting the Chiller

This screen provides the ability to start chiller operation.

Figure 9 – Chiller Start

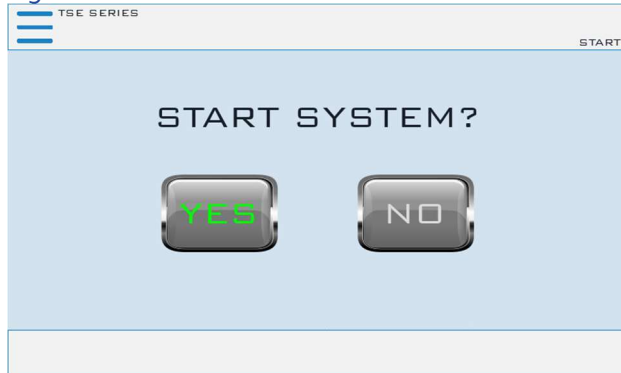

### Stopping the Chiller

This screen provides the ability to stop chiller operation.

Figure 10 – Chiller Stop

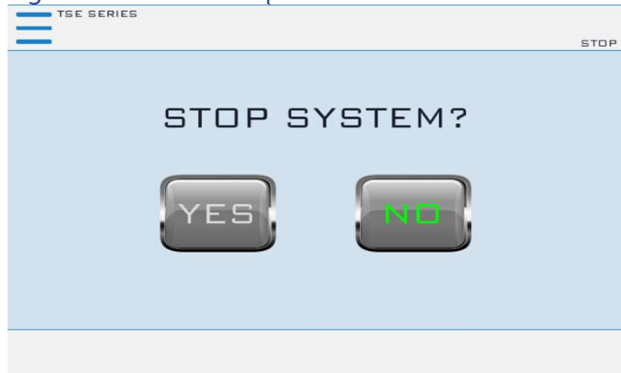

## Menu 1 - Overview

Figure 11 - Menu 1 Screen contains buttons to allow navigation to various sections of the control system. Some parameters are password protected. The main User level password is for gaining access to changing the main system set point and various other warning and alarm settings. A few higher-level areas require a high-level "Supervisor" password. Contact our Customer Service Department for assistance in accessing any restricted menus.

Figure 11 – Menu 1 Screen

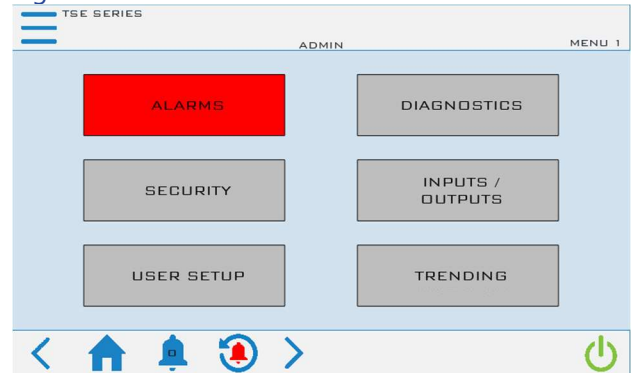

## Menu 2 - Overview

Figure 12 - Menu 2 Screen contains additional functionality. This includes the ability to show a full screen view as well as updating the HMI program via thumb drive.

Figure 12 – Menu 2 Screen

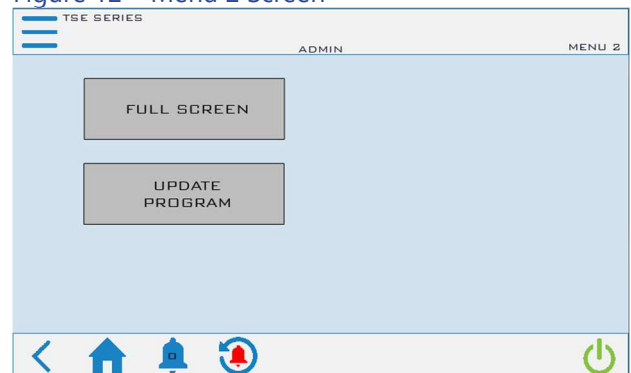



## Menu 1 - Alarms

### Alarms Active

When a critical system fault occurs, the controller logs the faults to the HMI alarm handler. To silence this alarm, press the ALARM SILENCE button. If multiple alarms are active at once, use the DOWN and UP buttons to view all alarms. All alarms must be resolved and then reset using the RESET ALARM button.

Figure 13 –Alarms Active Handler

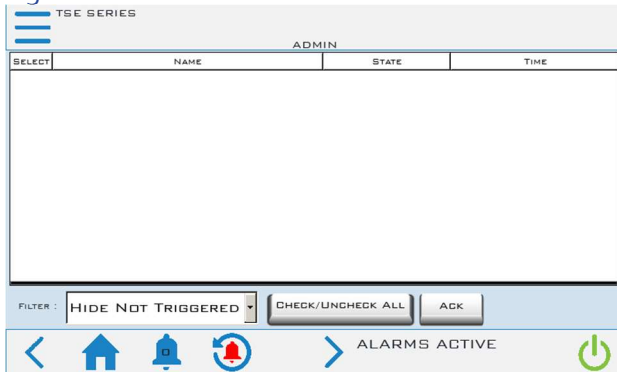

Note: The above shows there are no alarms; if an alarm condition were present, it would appear in this window.

### Alarms History

Figure 14 – Alarm History

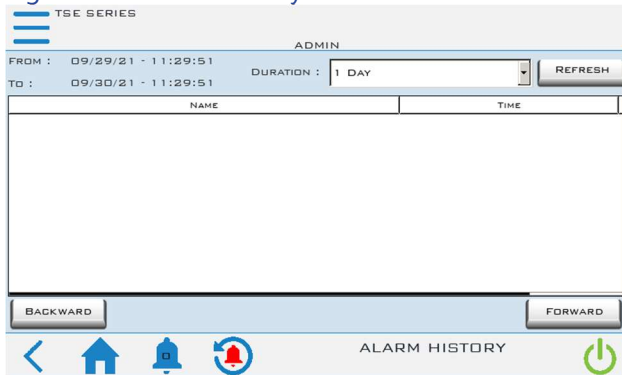

Note: The above shows there are no alarms in history; if an alarm condition previously existed, it would appear in this window.

### Warning Glycol

If the Chiller Setpoint goes below 45°F, the Glycol Warning Screen will appear as in Figure 15. The amount of antifreeze will vary depending on the actual desired operating conditions and should be enough to provide freeze protection to temperatures 15°F colder than the coldest temperature anticipated. Use only antifreeze solutions designed for heat exchanger duty. Do not use automotive antifreeze due to the potential for fouling that can occur once its relatively short-lived inhibitors break down. Verify the proper Glycol solution is used and acknowledge "OK" the Warning.

Figure 15 – Warning Antifreeze



# Menu 1 – Diagnostics

## Diagnostics Menu

The diagnostics screens provide detailed information about the various portions of the system.

Figure 16 – Diagnostics Menu Screen

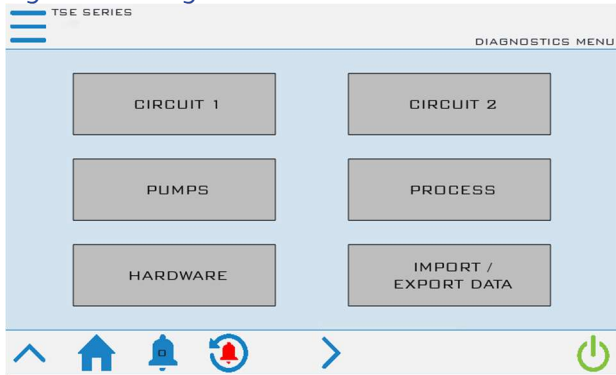

Figure 17 – Diagnostics Circuit Details Screen

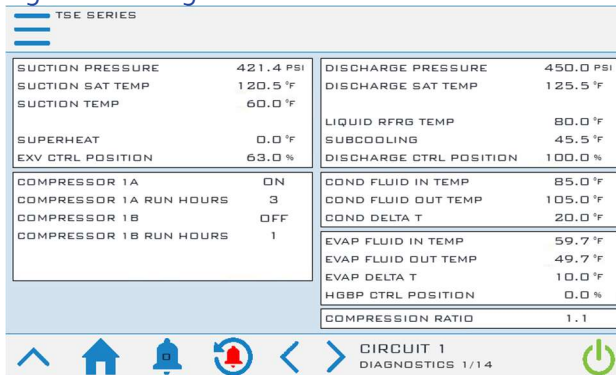

Figure 18 – Diagnostics Circuit Interlock Screen

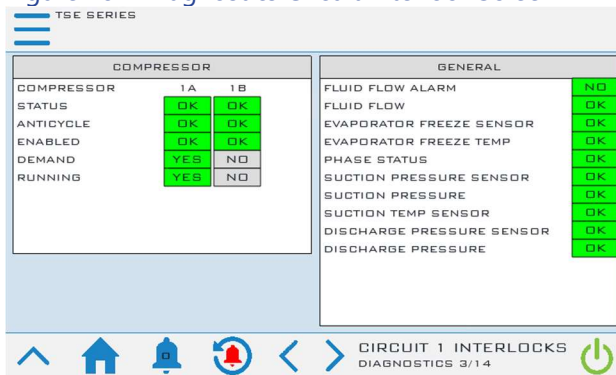

Figure 19 – Diagnostics Pumps Screen

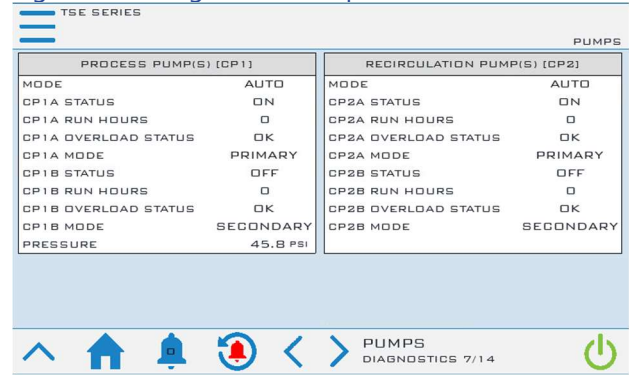

Figure 20 – Chiller Tank Screen

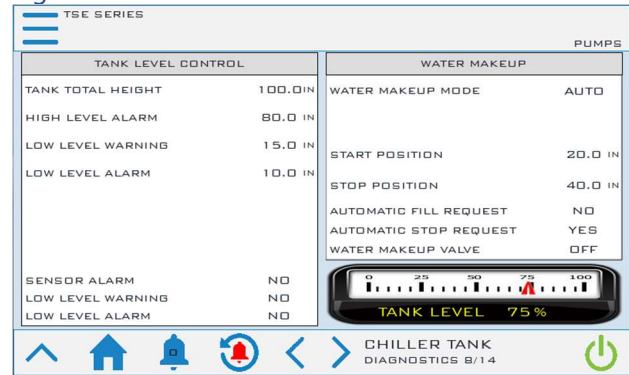

Figure 21 – Diagnostics Process Screen

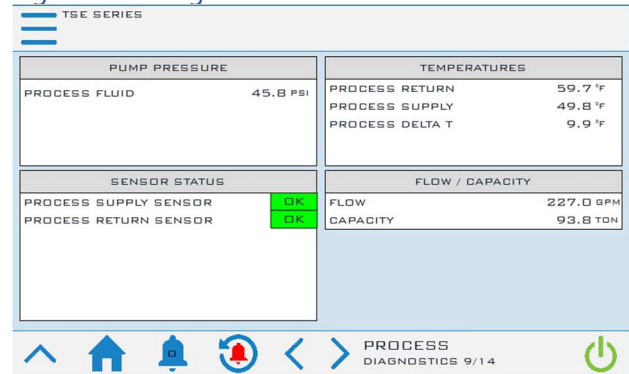

Figure 22 – Diagnostics Hardware Screen

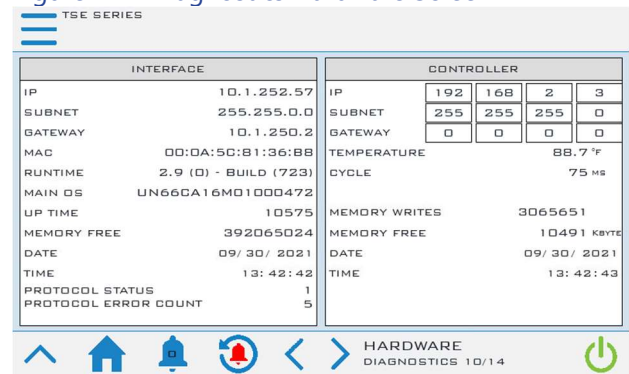

Figure 23 – Diagnostics Import/Export Data Screen

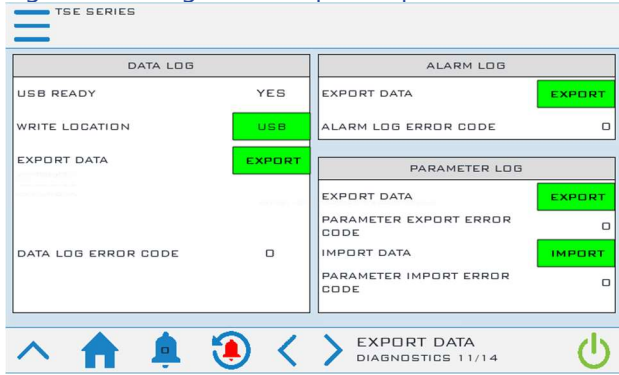

Figure 26 - Security – Log In Screen

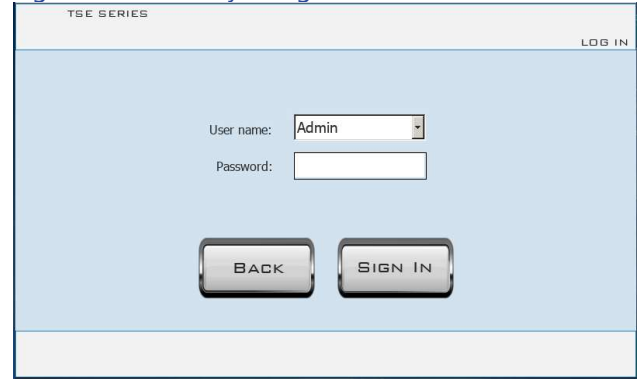

Figure 24 – Diagnostics Overview Screen

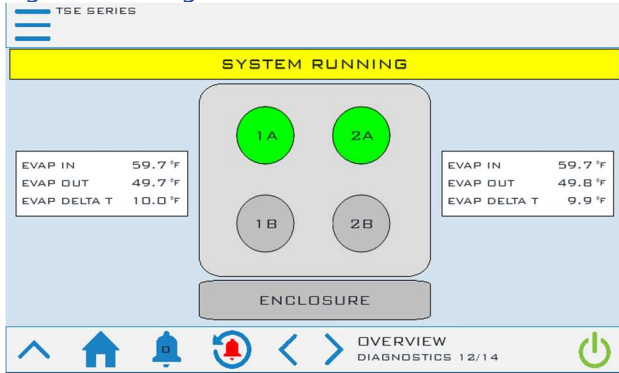
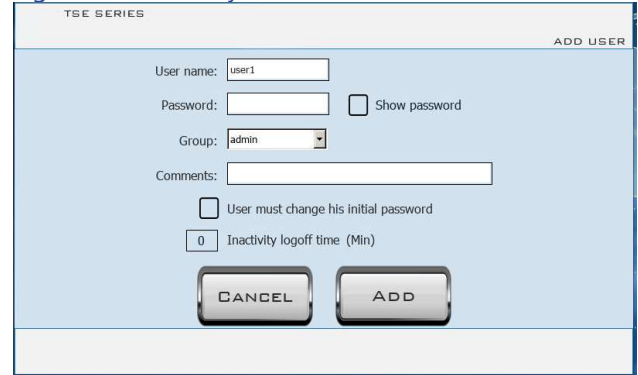

Figure 27 - Security – Add User Screen



## Menu 1 – Security

### Security Menu

To add protection to sensitive areas of the control program and provide some level of supervisory control to some operating parameters, the control system includes some security level protections.

Figure 25 - Security Menu

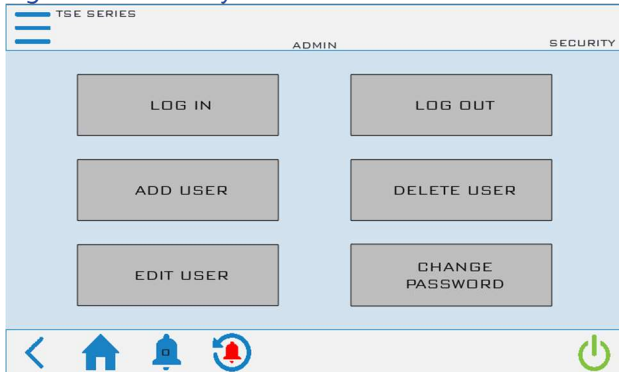

Figure 28 - Security – Edit User Screen

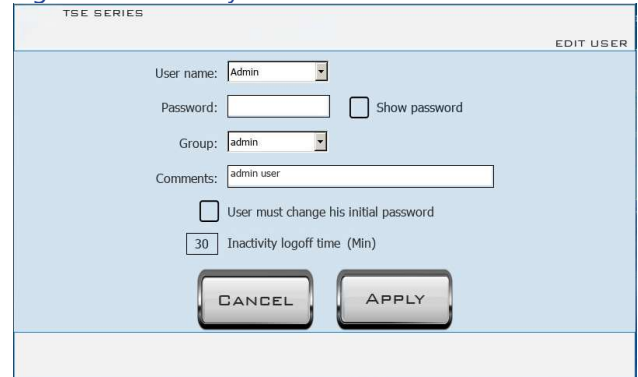

Figure 29 - Security – Delete User Screen



Figure 30 - Security – Change Password Screen

The screen is titled "TSE SERIES" and "CHANGE PASSWORD". It features three input fields for "Old password:", "New password:", and "Confirm password:". Below the fields is a checkbox labeled "Show password". At the bottom, there are two buttons: "CANCEL" and "CHANGE".

Table 9 - Security – Users and Passwords

User Name	Password	Screen Reference
User	9999	None
Supervisor	7720	None
Admin		None

## Menu 1 – Inputs / Outputs

The Input / Output screens display the status of the various system inputs and outputs. This provides a detailed level of information for monitoring system operation and for diagnosing any performance issues or alarms that arise.

Figure 31 - Main Inputs/Outputs Screen

The screen is titled "TSE SERIES" and "ADMIN" with "I/O MENU" on the right. It displays six large buttons arranged in a 3x2 grid: "TEMPERATURE INPUTS", "PRESSURE INPUTS", "ANALOG INPUTS", "DIGITAL INPUTS", "ANALOG OUTPUTS", and "DIGITAL OUTPUTS". At the bottom, there is a navigation bar with icons for home, alarm, and power, and a status indicator.

Figure 32 - Inputs/Outputs – Temperature Inputs Screen

The screen is titled "TSE SERIES" and "ADMIN". It displays a grid of temperature input values in degrees Fahrenheit. The values are: PROCESS RETURN (59.7°F), CONDENSER FLUID IN (85.0°F), PROCESS SUPPLY (49.8°F), CKT1 EVAP LEAVING (49.7°F), CKT2 EVAP LEAVING (49.8°F), CKT1 RFRG SUCTION (60.0°F), CKT2 RFRG SUCTION (30.0°F), CKT1 RFRG LIQUID (80.0°F), CKT2 RFRG LIQUID (80.3°F), CKT1 COND FLUID OUT (105.0°F), and CKT2 COND FLUID OUT (85.0°F). At the bottom, there is a navigation bar with icons for home, alarm, and power, and a status indicator "TEMPERATURE INPUTS I/O 1 OF 9".

Figure 33 - Inputs/Outputs – Pressure Inputs Screen

The screen is titled "TSE SERIES" and "ADMIN". It displays a grid of pressure input values in PSI. The values are: CKT1 RFRG SUCTION (421.4 PSI), CKT2 RFRG SUCTION (118.8 PSI), CKT1 RFRG DISCHARGE (450.0 PSI), and CKT2 RFRG DISCHARGE (450.0 PSI). At the bottom, there is a navigation bar with icons for home, alarm, and power, and a status indicator "PRESSURE INPUTS I/O 3 OF 9".

Figure 34 - Inputs/Outputs – Analog Inputs Screen

The screen is titled "TSE SERIES" and "ADMIN". It displays a single input field for "REMOTE SETPOINT" with a value of "0.0 %". At the bottom, there is a navigation bar with icons for home, alarm, and power, and a status indicator "ANALOG INPUTS I/O 4 OF 9".

Figure 35 - Inputs/Outputs – Digital Inputs Screen

The screen is titled "TSE SERIES" and "ADMIN". It displays a grid of digital input status values. The values are: REMOTE START (OFF), CKT1 HIGH RFRG PX SWITCH (ON), CKT2 HIGH RFRG PX SWITCH (ON), CKT1 EVAP FLOW (ON), CKT2 EVAP FLOW (ON), PHASE MONITOR (ON), IPR (OFF), COMPRESSOR 1A OK (ON), COMPRESSOR 2A OK (ON), COMPRESSOR 1B OK (ON), COMPRESSOR 2B OK (ON), CP1A STATUS (OK), CP2A STATUS (OK), CP1B STATUS (OK), and CP2B STATUS (OK). At the bottom, there is a navigation bar with icons for home, alarm, and power, and a status indicator "DIGITAL INPUTS I/O 5 OF 9".

Figure 36 - Inputs/Outputs – Analog Outputs Screen



Figure 37 - Inputs/Outputs – Digital Outputs Screen

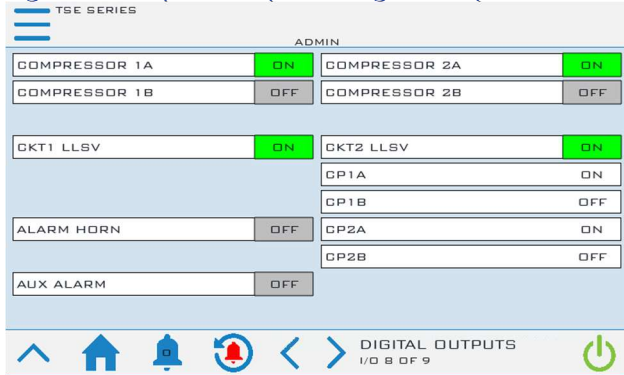
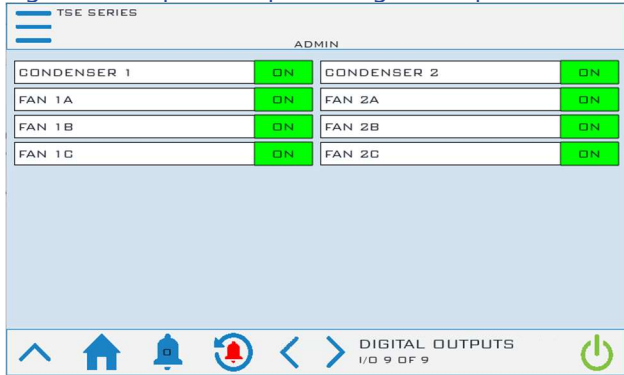

Figure 38 - Inputs/Outputs – Digital Outputs Screen



Note: This is an example of a chiller with an air-cooled condenser, your screen may appear slightly different based on your actual chiller configuration.

## Menu 1 – User Setup

The control system allows for customization and adjustment of many parameters. In most cases, the factory default settings are sufficient; however, adjustment of parameters and settings is possible through the User Setup menus.

Figure 39 - User Setup - Menu 1 Screen

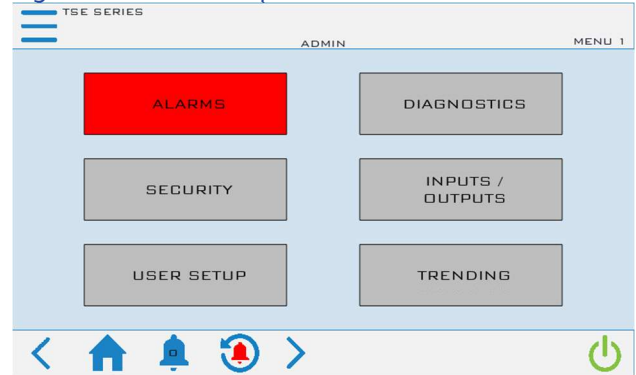

Figure 40 - User Setup - Menu 2 Screen

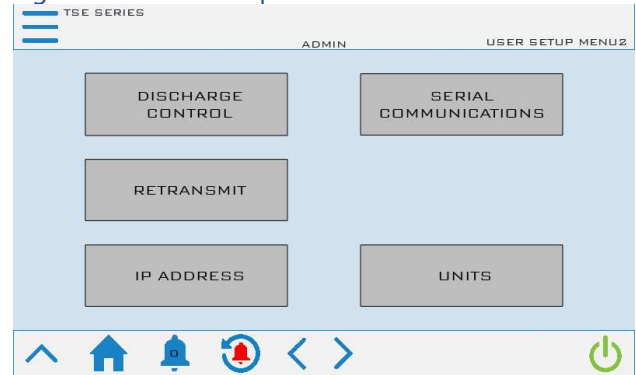

Figure 41 - User Setup - Menu 3 Screen

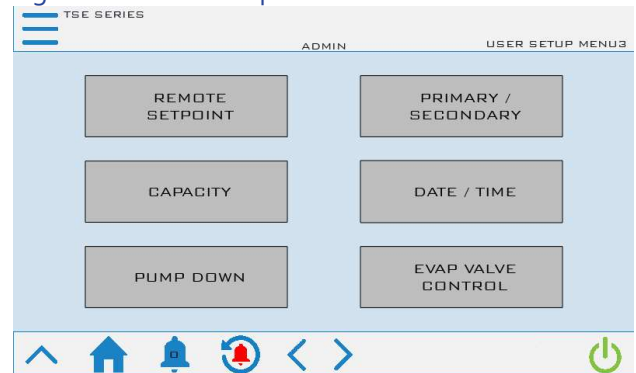

Figure 42 - User Setup - Menu 4 Screen

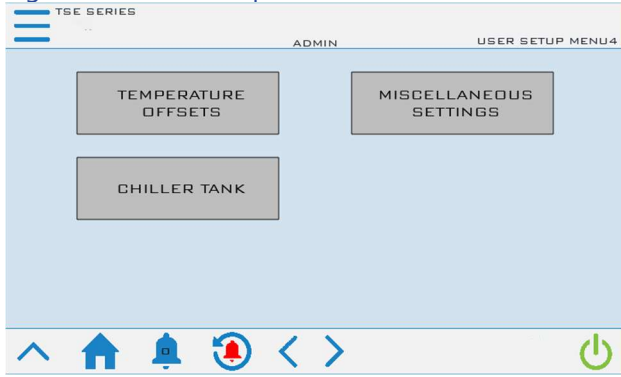
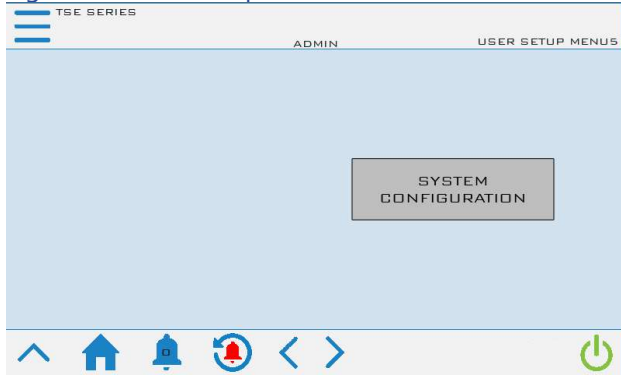

Figure 43- User Setup - Menu 5 Screen



## User Setup – Alarm Setup

Figure 44 - User Setup - Alarm Setup Screen

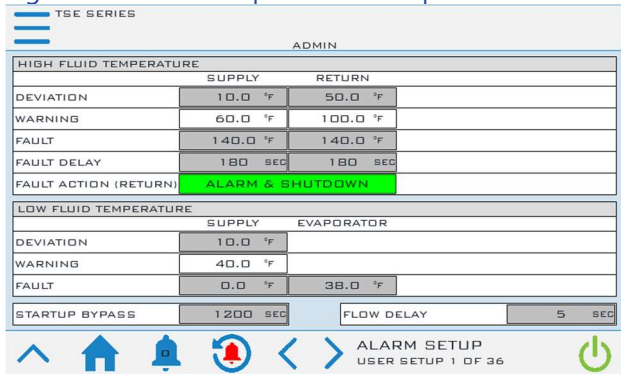

Table 10 – Alarm Setup Parameters

Menu Item	Description	Default Value
<b>High Fluid Temperature</b>		
Deviation	This deviation determines the warning trigger above chiller setpoint	Supply 10.0°F Return 50.0°F
Warning	Displays the calculated setpoint for the warning based on the deviation setpoint	
Fault	Absolute Temperature which the fault trigger will occur	140°F
Fault delay	Delay before the alarm will take action	180 sec.
Fault Action	Action takes when high return fluid alarm occurs	Alarm & Shutdown
<b>Low Fluid Temperature</b>		
Deviation	This deviation determines the warning trigger below chiller setpoint	Supply 10.0°F
Warning	Displays the calculated setpoint for the warning based on the deviation setpoint	
Fault	Absolute Temperature which the fault trigger will occur	Supply 0.0°F Evap 38.0°F
Startup Bypass	Delay time once the system has started before monitoring High and Low temperature Alarms.	1200 sec.
Flow Delay	Flow Sensor fault delay timer	5 sec.

## User Setup – Hot Gas Bypass

Figure 45 - User Setup – Hot Gas Bypass Setup Screen

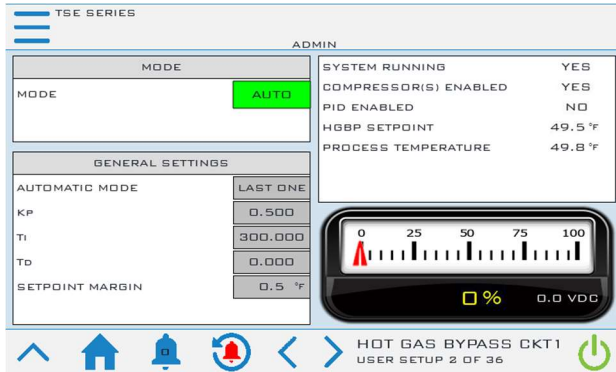

Table 11 – Hot Gas Bypass Valve Setup Parameters

Menu Item	Description	Default Value
Mode Selection	AUTO = Follow Automatic Mode MANUAL = The manual mode value percent will be the output to the valve.	AUTO
Automatic Mode Selection	OFF = The valve will always be closed (zero output) LAST ONE = The valve will only respond relative to the demand PID when operating with the last compressor running ALWAYS = The valve will always respond relative to the demand PID regardless of how many compressors are running.	Last One
Kp	Proportional PID value	0.500
Ti	Integral PID value	300.000
Td	Derivative PID value	0.000
Setpoint Margin	Temperature deviation below chiller setpoint to be used for hot gas bypass control setpoint	0.5°F

## User Setup – Pump Control

### Pump Control Screen

This screen displays pertinent pump status information for a system with the optional integral pump controls and provides the ability to change mode selection.

*Note: Your screen may appear slightly different based on your actual chiller configuration.*

Figure 46 - User Setup – Pumps Screen (Dedicated Backups)

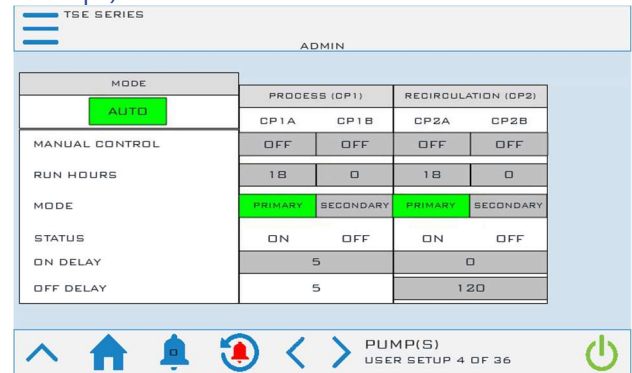

Figure 47 - User Setup – Pumps Screen (Dual Standby)

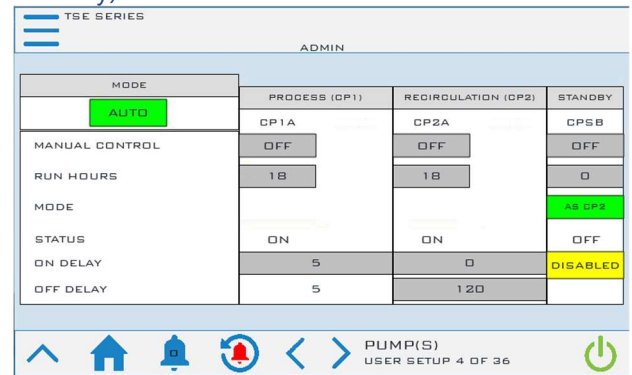
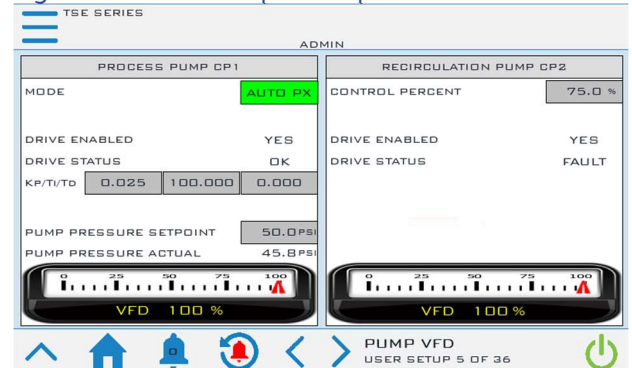

Figure 48 - User Setup – Pumps VFD



## User Setup – EEV Control

The electronic expansion valve meters the amount of refrigerant into the evaporator in the precise quantity in order to maintain superheat. The difference between the saturated suction temperature and the suction line temperature is the superheat.

Figure 49 - User Setup – EEV Control Setup Screen

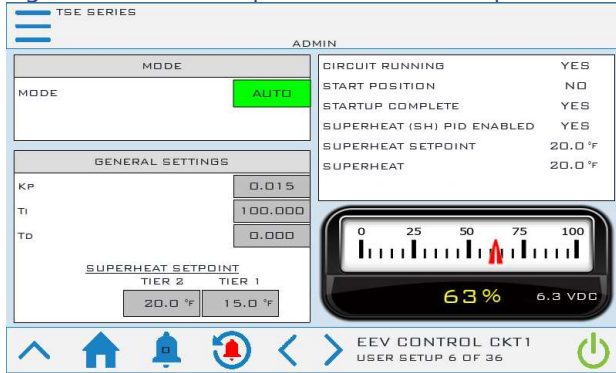

Table 12 – EEV Control Setup Parameters

Menu Item	Description	Default Value
Mode Selection	In Auto Mode, the control system adjusts the valve to maintain Super Heat. In manual mode, the system drives the valve to a fixed position and holds it there for service diagnostic purposes.	AUTO
Superheat Setpoint	The superheat varies depending on the number of compressors in operation for the specific refrigeration circuit. Only a trained refrigeration service technician should adjust these valves.	Tier 1: 15.0 Tier 2: 20.0
Kp	Proportional PID value	0.015
Ti	Integral PID value	100.000
Td	Derivative PID value	0.000

## User Setup – Compressor Staging

Figure 50 - User Setup – Compressor Staging Setup Screen

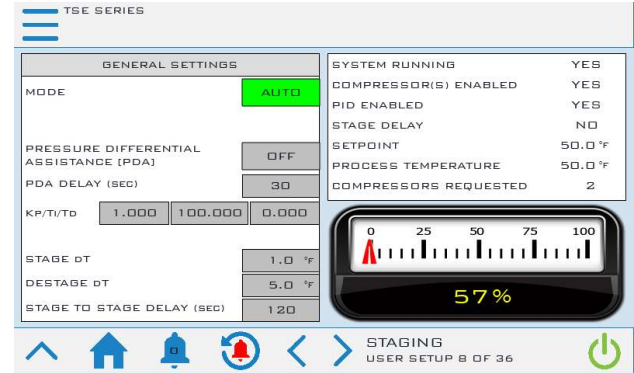

Table 13 – Compressor Staging Setup Parameters

Menu Item	Description	Default Value
Staging Mode	In Auto Mode, the control system adjusts the number of staged compressors relative to the demand and available compressors. In manual mode, the number of staged compressors depends on the Manual Mode Value relative to available compressors.	AUTO
Pressure Differential Assistance (PDA)	Pressure Differential Assistance will energize all compressors when the circuit first starts for the time specified in the PDA Delay parameter.	OFF
PDA Delay	Delay time to run II compressor on circuit start	30 sec
Kp	Proportional PID value	1.000
Ti	Integral PID value	100.000
Td	Derivative PID value	0.000
Stage ΔT	If the process value rises above the set point by this differential, the first compressor will turn on.	1°F
Destage ΔT	If the process value drops below the set point by this differential, all compressors turn off.	5°F
Stage to Stage Delay	This is the minimum delay duration between stages on multiple compressors. During this time delay, the demand percent calculation ceases to allow the impact of the newly staged compressor to influence the system.	120 sec



## User Setup – Stage Order

### Compressor Stage Order Screen

Depicts the stage order of the local chiller. The stage order calculation uses the hours entered in the auto-stage threshold parameter. The intent is to run the compressors with the least amount of hours first to help equalize the run hours of all the compressors

Figure 51 - User Setup – Stage Order Setup Screen

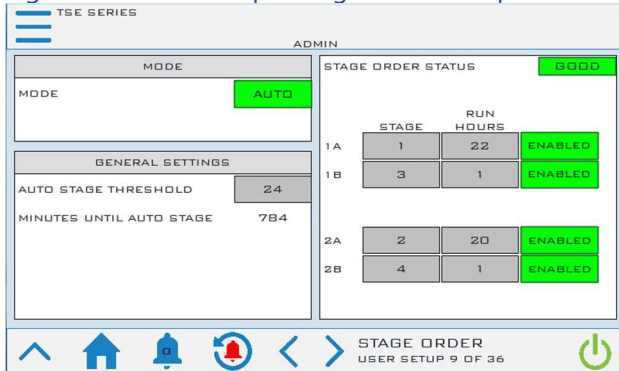

Table 14 – Stage Order Setup Parameters

Menu Item	Description	Default Value
Stage Mode	Automatic: calculates the stage order by the AUTO STAGE THRESHOLD parameter Manual: Manually enter the stage order	AUTO
Auto Stage Threshold	The number of run hours before recalculating the stage order	24 HOURS
Minutes Until Auto Stage	Minutes remaining until the stage calculation occurs	None

## User Setup – Discharge Control Setup

### Discharge Control Setup Screen

An electric condenser water-regulating valve is standard on chillers with a water-cooled condenser. The valve is a butterfly type valve with a modulating actuator and is located in the condenser water piping at the outlet of the condenser. The valve regulates the flow of cooling water through the condenser in order to maintain the discharge refrigerant pressure set point.

On remote air-cooled chillers with EC fan control, the analog output will ramp all fans up and down simultaneously in order to achieve discharge pressure setpoint.

Figure 52 - User Setup – Discharge Control Setup Screen

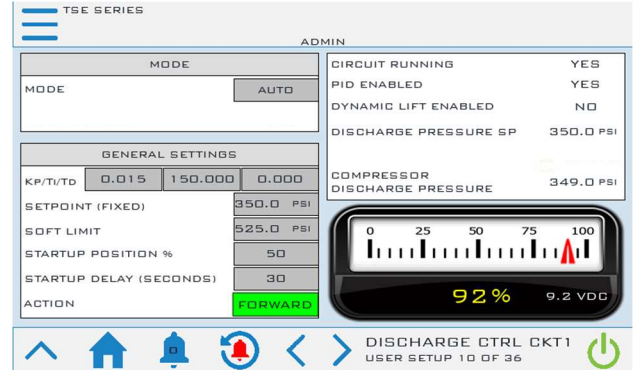

Table 15 – Discharge Control Setup Parameters

Menu Item	Description	Default Value
Mode	In Auto Mode, the fans adjust to maintain optimum performance. In manual mode, it holds to the Manual Mode Position input valve.	AUTO
Kp	Proportional PID value	0.015
Ti	Integral PID value	150.000
Td	Derivative PID value	0.000
Discharge Setpoint	Discharge Setpoint Value	350 PSIG
Low Temp Setpoint	Low temp setpoint relating to low percent setpoint – (During the start sequence)	45°F (7°C)

On remote air-cooled chillers with fixed fan stages and a variable header fan, the analog output will ramp the variable header fan up and down and activate the fixed fan stages in order to achieve discharge pressure setpoint.

Figure 53 - User Setup – Discharge Control Setup Screen (Remote Air Cooled)

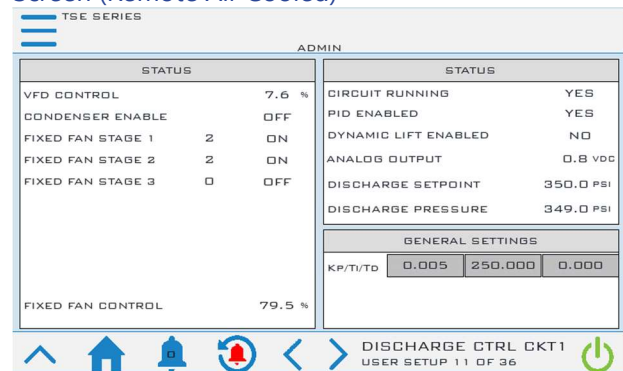

Table 16 – Discharge Control Setup Parameters

Menu Item	Description	Default Value
Kp	Proportional PID value	0.005
Ti	Integral PID value	250.000
Td	Derivative PID value	0.000

## User Setup – Dynamic Lift Setup

### Dynamic Lift Setup Screen

The Dynamic Lift control logic adjusts the chiller head pressure to improve energy efficiency.

Figure 54 - User Setup – Dynamic Lift Setup Screen

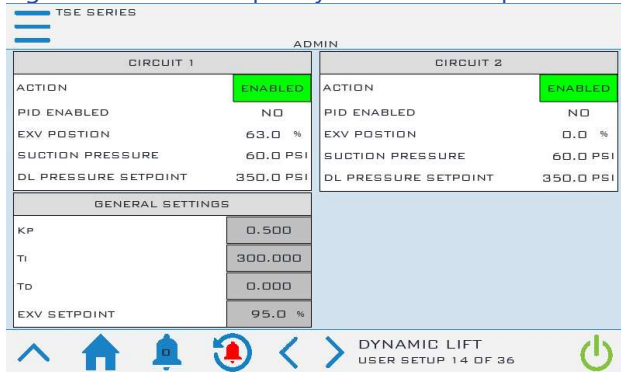

Table 17 – Dynamic Lift Parameters

Menu Item	Description	Default Value
Action	Enable or Disable the Dynamic lift feature	ENABLED
Kp	Proportional PID value	0.500
Ti	Integral PID value	300.000
Td	Derivative PID value	0.000
EXV Setpoint	Optimal EXV target position	95%

## User Setup – Serial Communications Setup

### Modbus RTU Setup Screen

This Modbus RTU Setup Screen provides the ability to modify communication parameters. Default Modbus RTU Settings: Baud-57600, Data Length-8, Parity-Odd, Stop Bits-1.

Figure 55 - User Setup – Modbus RTU Setup Screen

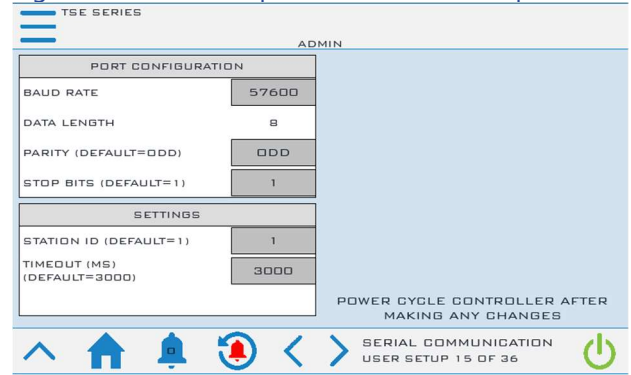

## User Setup – Temperature Retransmit

Figure 56 - User Setup – Temperature Retransmit Setup Screen

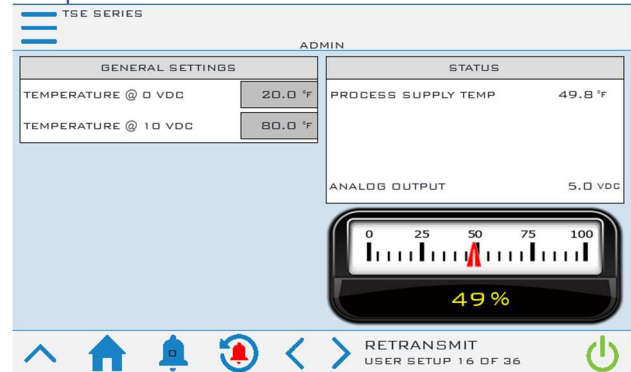

## User Setup – IP Address

Figure 57 - User Setup – IP Address Setup Screen

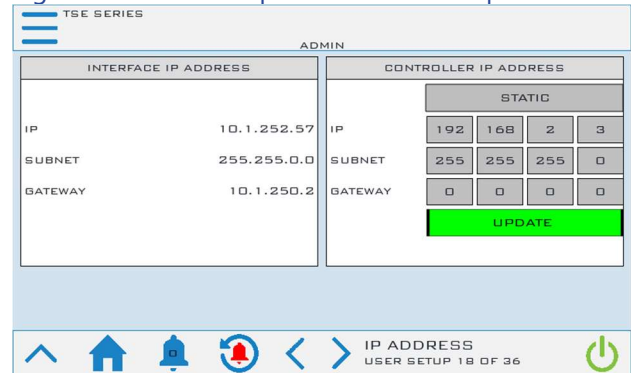

## User Setup – Units

Figure 58 - User Setup – Display Units Setup Screen

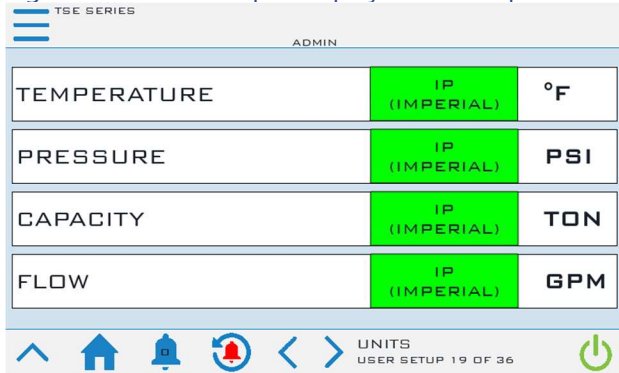

## User Setup – Remote Setpoint

When the remote setpoint option is active, an incoming 4-20mA or 0-10VDC signal controls the setpoint of the primary chiller. The signal will span from the MINIMUM TEMPERATURE to the MAXIMUM TEMPERATURE as defined in the following figure.

Figure 59 - User Setup – Remote Setpoint Setup Screen

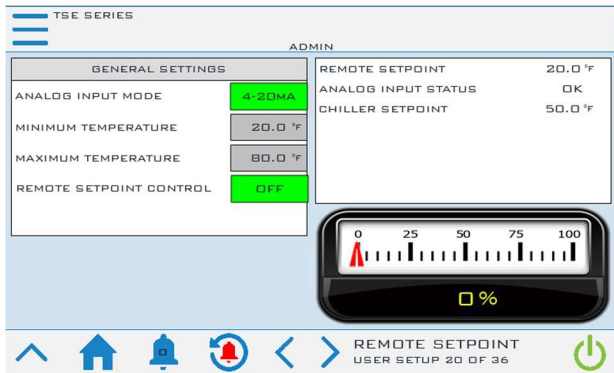

## User Setup – Primary / Secondary

Figure 60 - User Setup – Primary / Secondary Setup Screen

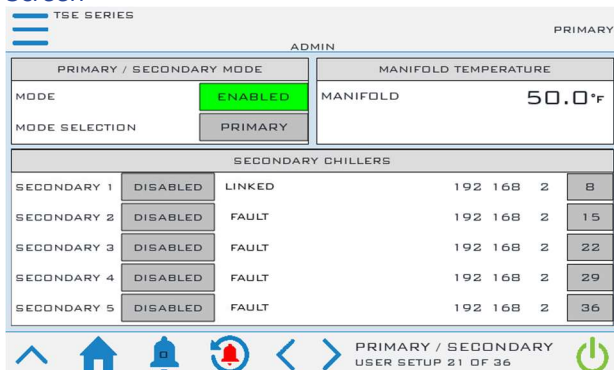

## User Setup – Chiller Capacity

### Chiller Capacity Screen

This screen is necessary to adjust the nominal pipe size where the flow sensor is inserted.

Figure 61 - User Setup – Chiller Capacity Setup Screen

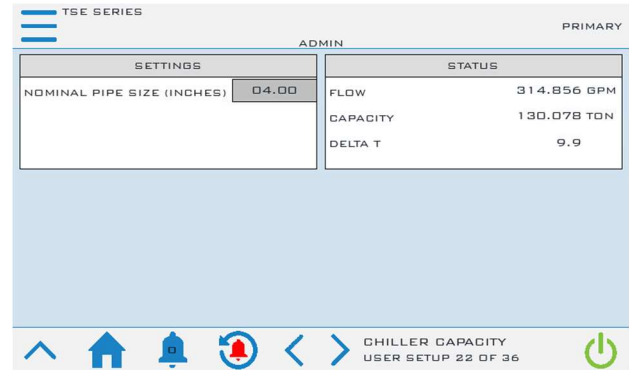

## User Setup – Date/Time

### Date/Time Screen

Date and Time is necessary for accurate data logging as well as fault log time stamps. Touch the fields for adjustment.

Figure 62 - User Setup – Date / Time Setup Screen

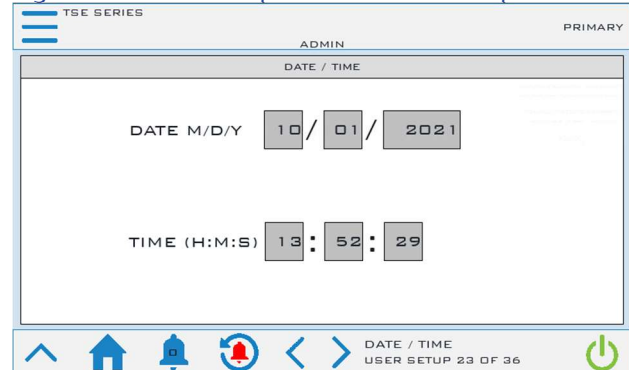

## User Setup – Pump Down

### Pump Down Screen

This screen allows for adjustments to the pump down sequence. The default mode depends on chiller configuration

Figure 63 - User Setup – Pump Down Setup Screen

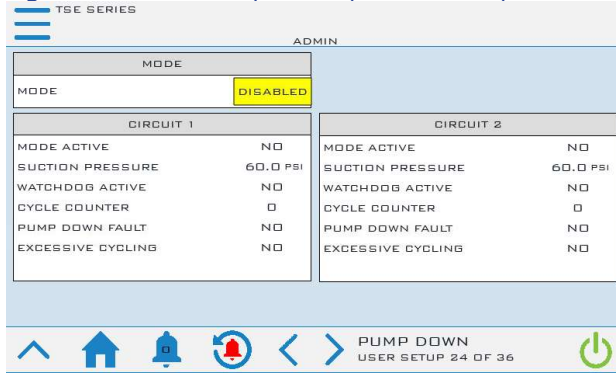

## User Setup – Evaporator Valve

### Evaporator Valve Control Screen

This feature provides the ability to close off evaporator fluid flow when a circuit is not in operation. This allows for tighter temperature control.

Figure 64 - User Setup – Evaporator Valve Control Setup Screen

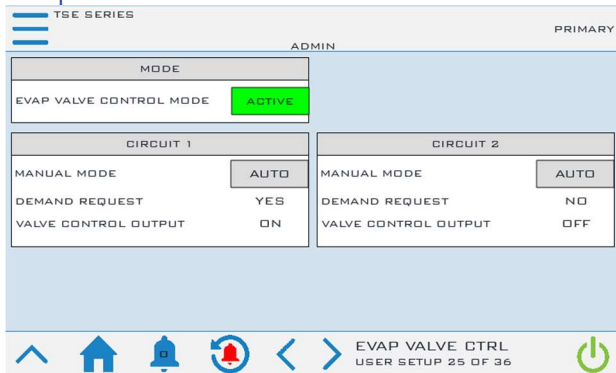

## User Setup – Misc. Process Control

The chiller setpoint can be controlled via process supply or process return. Default control method is configured for process supply. In some applications, it is advantageous to control via process return.

## User Setup – Misc. Local Mode

The Local/Remote Mode toggle indicates if the chiller is set to use a remote contact closure for remote start/stop. When active, the Local Mode toggle will indicate Local mode Digital Start/Stop Enabled and when not active it will indicate Local Mode Digital Start/Stop Disabled.

## User Setup – Misc. Automatic Start

The Automatic Start toggle indicates if the chiller is set to automatically start if a power outage has occurred during a run state. When active, the Automatic Start toggle will indicate Automatic Start Enabled and when not active it will indicate Automatic Start Disabled.

## User Setup – Misc. Current Sensors

The Current Sensors toggle indicates if the chiller is set to automatically monitor the compressor current sensors when energized.

Figure 65 - User Setup – Miscellaneous Control Setup Screen

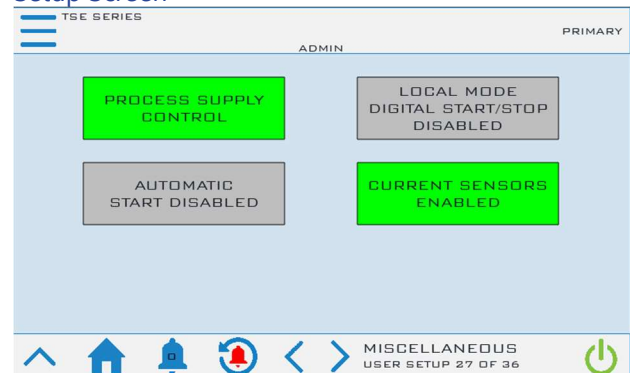

## User Setup – Chiller Tank and Water Makeup

On integral tank systems a pressure transducer is included in order to indicate tank level. A water makeup option existed and can be configure with the following screen.

Figure 66 - User Setup – Chiller Tank and Water Makeup Setup Screen

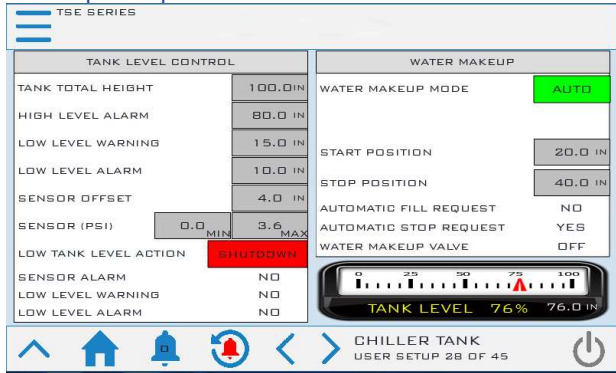

## User Setup – Short Cycle

Provides the ability to eliminate short cycling in low load conditions.

Figure 67 – Short Cycle Enabled Screen

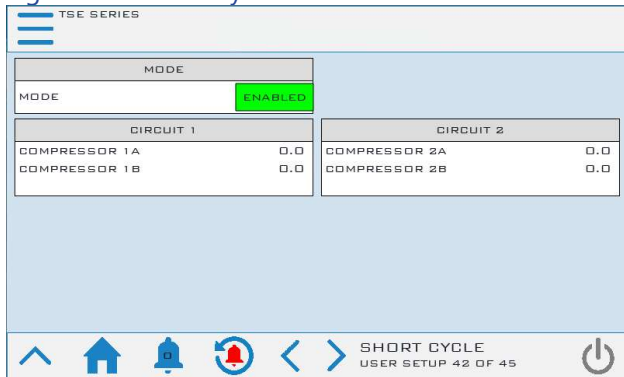
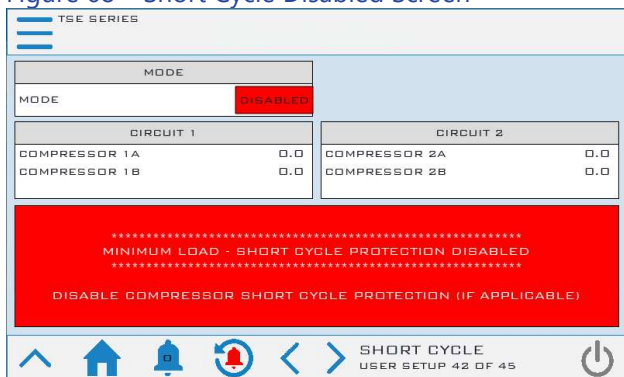

Figure 68 – Short Cycle Disabled Screen



## Menu 1 – Trending

A graphical representation of the core operating parameters of the system are in the trending screens. The trending screen displays the setpoint temperature, evaporator fluid out, process supply and return temperature, and optional hot gas bypass valve resisters (if present) for easy analysis of the system operation. Trending is always enabled and always running.

Figure 69 - System Trending 1 Screen



Figure 70 - System Trending 2 Screen



Figure 71 - System Trending 3 Screen



Figure 72 - System Trending 4 Screen



## Menu 2 – Full Screen

Provides a simple, large-font display of the process supply temperature for users who are primarily concerned only with this data point of the system operation.

Figure 73 - Menu 2 – Full Screen

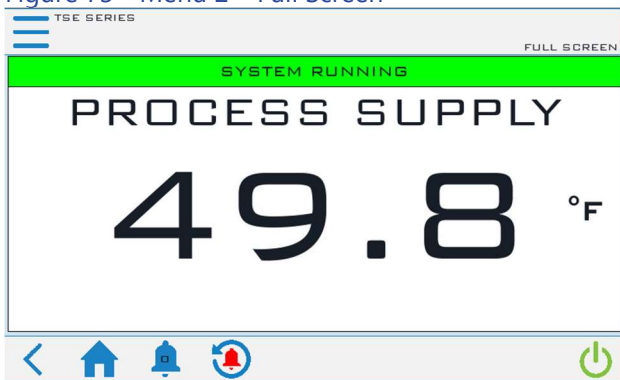

## Modbus

Table 18 – Modbus Table

Type	Index	Size	Variable Name	Data Type
Coil	0	1	HMI_START	Bool
Coil	1	1	HMI_STOP	Bool
Coil	2	1	SYSTEM_RUNNING	Bool
Coil	3	1	SYSTEM_STOPPING	Bool
Coil	4	1	PULSE_2SEC	Bool
Coil	5	1	UNITS_TEMPERATURE	Bool
Coil	6	1	UNITS_PRESSURE	Bool
Coil	7	1	CKT1_COMPRESSORS_RUNNING	Bool
Coil	8	1	CKT2_COMPRESSORS_RUNNING	Bool
Coil	9	1	CKT1_EVAP_FLOW_SWITCH_OK	Bool
Coil	10	1	CKT2_EVAP_FLOW_SWITCH_OK	Bool
Coil	11	1	AL_ALARMS_PRESENT	Bool
Coil	12	1	AL_GENERAL_ALARMS	Bool
Coil	13	1	AL_PRB_CKT1_EVAP_OUT_FLUID.Active	Bool
Coil	14	1	AL_PRB_CKT2_EVAP_OUT_FLUID.Active	Bool
Coil	15	1	AL_PRB_CKT1_SUCTION_TEMP.Active	Bool
Coil	16	1	AL_PRB_CKT2_SUCTION_TEMP.Active	Bool
Coil	17	1	AL_PRB_CKT1_SUCTION_PX.Active	Bool
Coil	18	1	AL_PRB_CKT2_SUCTION_PX.Active	Bool
Coil	19	1	AL_PRB_CKT1_DISCHARGE_TEMP.Active	Bool
Coil	20	1	AL_PRB_CKT2_DISCHARGE_TEMP.Active	Bool
Coil	21	1	AL_PRB_CKT1_DISCHARGE_PX.Active	Bool
Coil	22	1	AL_PRB_CKT2_DISCHARGE_PX.Active	Bool
Coil	23	1	AL_PRB_CKT1_LIQUID_TEMP.Active	Bool
Coil	24	1	AL_PRB_CKT2_LIQUID_TEMP.Active	Bool
Coil	25	1	AL_PRB_PROCESS_RETURN_FLUID.Active	Bool
Coil	26	1	AL_PRB_PROCESS_SUPPLY_FLUID.Active	Bool
Coil	27	1	AL_CKT1_RFRG_ALARM	Bool
Coil	28	1	AL_CKT2_RFRG_ALARM	Bool
Coil	29	1	AL_CKT1_CRITICAL_ALARM	Bool
Coil	30	1	AL_CKT2_CRITICAL_ALARM	Bool
Coil	31	1	AL_CKT1_FREEZESTAT.Active	Bool
Coil	32	1	AL_CKT2_FREEZESTAT.Active	Bool
Coil	33	1	AL_CKT1_EVAP_FLOW.Active	Bool
Coil	34	1	AL_CKT2_EVAP_FLOW.Active	Bool
Coil	35	1	AL_CKT1_LPS.Active	Bool
Coil	36	1	AL_CKT2_LPS.Active	Bool
Coil	37	1	AL_CKT1_LLPS.Active	Bool
Coil	38	1	AL_CKT2_LLPS.Active	Bool
Coil	39	1	AL_COMP1A_STATUS_FAULT.Active	Bool
Coil	40	1	AL_COMP2A_STATUS_FAULT.Active	Bool
Coil	41	1	AL_COMP1B_STATUS_FAULT.Active	Bool
Coil	42	1	AL_COMP2B_STATUS_FAULT.Active	Bool
Coil	43	1	AL_COMP1C_STATUS_FAULT.Active	Bool
Coil	44	1	AL_COMP2C_STATUS_FAULT.Active	Bool
Coil	45	1	AL_HIGH_HIGH_RETURN_FLUID_TEMP.Active	Bool
Coil	46	1	AL_HIGH_HIGH_SUPPLY_FLUID_TEMP.Active	Bool
Coil	47	1	AL_LOW_LOW_SUPPLY_FLUID_TEMP.Active	Bool
HoldingRegister	1	2	CHILLER_SETPOINT	Real
InputRegister	1	2	PLC_VERSION	Real
InputRegister	3	1	SYSTEM_DEMAND_PERCENT	Int
InputRegister	4	1	HMI_ALARM_DISPLAY	Int
InputRegister	5	1	CHILLER_STATUS	UInt
InputRegister	6	2	CKT1_RFRG_SUCTION_TEMP_HMI	Real
InputRegister	8	2	CKT2_RFRG_SUCTION_TEMP_HMI	Real

Table 18 – Modbus Parameters (continued)

Type	Index	Size	Variable Name	Data Type
InputRegister	10	2	CKT1_SUCTION_PRESSURE_HMI	Real
InputRegister	12	2	CKT2_SUCTION_PRESSURE_HMI	Real
InputRegister	14	2	CKT1_SUCTION_SATURATED_TEMP_HMI	Real
InputRegister	16	2	CKT2_SUCTION_SATURATED_TEMP_HMI	Real
InputRegister	18	2	CKT1_SUPERHEAT_HMI	Real
InputRegister	20	2	CKT2_SUPERHEAT_HMI	Real
InputRegister	22	2	CKT1_RFRG_DISCHARGE_TEMP_HMI	Real
InputRegister	24	2	CKT2_RFRG_DISCHARGE_TEMP_HMI	Real
InputRegister	26	2	CKT1_DISCHARGE_PRESSURE_HMI	Real
InputRegister	28	2	CKT2_DISCHARGE_PRESSURE_HMI	Real
InputRegister	30	2	CKT1_DISCHARGE_SATURATED_TEMP_HMI	Real
InputRegister	32	2	CKT2_DISCHARGE_SATURATED_TEMP_HMI	Real
InputRegister	34	2	CKT1_SUBCOOLING_HMI	Real
InputRegister	36	2	CKT2_SUBCOOLING_HMI	Real
InputRegister	38	2	CKT1_LIQUID_TEMP_HMI	Real
InputRegister	40	2	CKT2_LIQUID_TEMP_HMI	Real
InputRegister	42	2	CKT1_EVAP_OUT_FLUID_HMI	Real
InputRegister	44	2	CKT2_EVAP_OUT_FLUID_HMI	Real
InputRegister	46	2	CKT1_EVAP_DELTA_T_HMI	Real
InputRegister	48	2	CKT2_EVAP_DELTA_T_HMI	Real
InputRegister	50	2	CKT1_DISCHARGE_PERCENT	Real
InputRegister	52	2	CKT2_DISCHARGE_PERCENT	Real
InputRegister	54	2	CONDENSER_FLUID_IN_TEMPERATURE_HMI	Real
InputRegister	56	2	CKT1_CONDENSER_FLUID_OUT_TEMP_HMI	Real
InputRegister	58	2	CKT2_CONDENSER_FLUID_OUT_TEMP_HMI	Real
InputRegister	60	2	CKT1_EVAP_IN_FLUID_HMI	Real
InputRegister	62	1	CKT2_EVAP_IN_FLUID_HMI	Real
InputRegister	64	2	CKT1_HGBP_PERCENT	Real
InputRegister	66	2	CKT2_HGBP_PERCENT	Real
InputRegister	68	2	CKT1_EXV_PERCENT	Real
InputRegister	70	2	CKT2_EXV_PERCENT	Real
InputRegister	72	2	MANIFOLD_LEAVING_FLUID_TEMPERATURE_HMI	Real
InputRegister	74	2	PROCESS_SUPPLY_FLUID	Real
InputRegister	76	2	PROCESS_RETURN_FLUID	Real
InputRegister	78	2	PROCESS_LOCAL_DELTA_T_HMI	Real
InputRegister	80	2	PROCESS_VARIABLE_HMI	Real



## Start-Up

Every unit is factory set to deliver chilled water in accordance with the standard operating specifications for that particular chiller. Due to variables involved with different applications and different installations, minor adjustments may be required during the initial start-up to ensure proper operation. Use a qualified refrigeration technician to perform the start-up procedure in sequence. The following serves as a checklist for the initial start-up and for subsequent start-ups if the chiller is out of service for a prolonged time.



**WARNING:** This equipment contains hazardous voltages that can cause severe injury or death.



**WARNING:** This equipment contains refrigerant under pressure. Accidental release of refrigerant under pressure can cause personal injury and or property damage.



**WARNING:** This equipment may contain fan blades or other sharp edges. Make sure all fan guards and other protective shields are securely in place.



**WARNING:** The exposed surfaces of motors, refrigerant piping, and other fluid circuit components can be very hot and can cause burns if touched with unprotected hands.



**CAUTION:** Disconnect and lock out incoming power before installing, servicing, or maintaining the equipment. Connecting power to the main terminal block energizes the entire electric circuitry of the unit. Electric power at the main disconnect should be shut off before opening access panels for repair or maintenance.



**CAUTION:** Wear eye protection when installing, maintaining, or repairing the equipment to protect against any sparks, debris, or fluid leaks.



**CAUTION:** Wear protective gloves when installing, maintaining, or repairing the equipment to protect against any sparks, debris, or fluid leaks.



**CAUTION:** Wire the unit ground in compliance with local and national codes.



**CAUTION:** The unit requires the main power to remain connected during off-hours to energize the compressor's crankcase heater. Disconnect main power only when servicing the chiller. The crankcase heater should remain on when the compressor is off to ensure liquid refrigerant does not accumulate in the compressor crankcase. Connect main power at least 24 hours prior to initial startup.

## Step 1 – Connect Main Power

Connect main power properly ensuring it matches the voltage shown on the nameplate of the unit. Check the electrical phase sequence prior to start-up. Operation of the compressor with incorrect electrical phase sequencing will cause damage to the compressors. Check the phasing prior to applying power. The proper sequence is "ABC." If the phasing is incorrect, open the main power disconnect and switch two line leads on the main power terminal blocks (or the unit mounted disconnect). All electrical components are in-phase at the factory. Do not interchange any load leads that are from the unit contactors or the motor terminals. After making proper power connection and grounding, turn the main power on.

## Step 2 – Fill Coolant Circuit

Check to make sure all process chilled-water piping connections are secure. Open the chiller cabinet and fill the coolant reservoir with the proper water or water/glycol solution following the guidelines shown below. When using a glycol solution only use glycol with a corrosion inhibitor.

### System Fill Water Chemistry Requirements

The properties of water make it ideal for heat transfer applications. It is safe, non-flammable, non-poisonous, easy to handle, widely available, and inexpensive in most industrialized areas.

When using water as a heat transfer fluid it is important to keep it within certain chemistry limits to avoid unwanted side effects. Water is a "universal solvent" because it can dissolve many solid substances and absorb gases. As a result, water can cause the corrosion of metals used in a cooling system. Often water is in an open system (exposed to air) and when the water evaporates, the dissolved minerals remain in the process fluid. When the concentration exceeds the solubility of some minerals, scale forms. The life giving properties of water can also encourage biological growth that can foul heat transfer surfaces.

To avoid the unwanted side effects associated with water cooling, proper chemical treatment and preventive maintenance is required for continuous plant productivity.

### Unwanted Side Effects of Improper Water Quality

- Corrosion
- Scale
- Fouling
- Biological Contamination

### Cooling Water Chemistry Properties

- Electrical Conductivity
- pH
- Alkalinity
- Total Hardness
- Dissolved gases

Chillers at their simplest have two main heat exchangers: one that absorbs the heat from the process (evaporator) and one that removes the heat from the chiller (condenser). All our chillers use stainless steel brazed plate evaporators. Our air-cooled chillers use air to remove heat from the chiller; however, our water-cooled chillers use either a tube-in-tube or shell-in-tube condenser which has copper refrigerant tubes and a steel shell. These, as are all heat exchangers, are susceptible to fouling of heat transfer surfaces due to scale or debris. Fouling of these surfaces reduces the heat-transfer surface area while increasing the fluid velocities and pressure drop through the heat exchanger. All of these effects reduce the heat transfer and affect the efficiency of the chiller.

The complex nature of water chemistry requires a specialist to evaluate and implement appropriate sensing, measurement and treatment needed for satisfactory performance and life. The recommendations of the specialist may include filtration, monitoring, treatment and control devices. With the ever-changing regulations on water usage and treatment chemicals, the information is usually up to date when a specialist in the industry is involved. Table 19 shows the list of water characteristics and quality limitations.

Table 19 – Fill Water Chemistry Requirements

Water Characteristic	Quality Limitation
Alkalinity (HCO <sub>3</sub> <sup>-</sup> )	70-300 ppm
Aluminum (Al)	Less than 0.2 ppm
Ammonium (NH <sub>3</sub> )	Less than 2 ppm
Chlorides (Cl <sup>-</sup> )	Less than 300 ppm
Electrical Conductivity	10-500µS/cm
Free (aggressive) Carbon Dioxide (CO <sub>2</sub> ) <sup>†</sup>	Less than 5 ppm
Free Chlorine(Cl <sub>2</sub> )	Less than 1 PPM
HCO <sub>3</sub> <sup>-</sup> /SO <sub>4</sub> <sup>2-</sup>	Greater than 1.0
Hydrogen Sulfide (H <sub>2</sub> S)*	Less than 0.05 ppm
Iron (Fe)	Less than 0.2 ppm
Manganese (Mn)	Less than 0.1 ppm
Nitrate (NO <sub>3</sub> )	Less than 100 ppm
pH	7.5-9.0
Sulfate (SO <sub>4</sub> <sup>2-</sup> )	Less than 70 ppm
Total Hardness (dH)k	4.0-8.5

\* Sulfides in the water quickly oxidize when exposed to air; therefore ensure agitation does not occur when taking a water sample. Unless tested immediately at the site, the sample will require stabilization with a few drops of one Molar zinc acetate solution, allowing accurate sulfide determination up to 24 hours after sampling. A low pH and high alkalinity cause system problems, even when both values are within the range shown. The term pH refers to the acidity, basicity, or neutrality of the water supply. Below 7.0, water is acidic. Neutral water contains a pH of 7.0.

† Dissolved carbon dioxide calculation is from the pH and total alkalinity values shown below or measured on the site using a test kit.

Dissolved Carbon Dioxide, PPM = TA x 2[(6.3-pH)/0.3] where TA = Total Alkalinity, PPM as CaCO<sub>3</sub>

Table 20 - Recommended Glycol Solutions

Chilled Water Temperature	Percent Glycol By Volume
50°F (10°C)	Not required
45°F (7.2°C)	5 %
40°F (4.4°C)	10 %
35°F (1.7°C)	15 %
30°F (-1.1°C)	20 %
25°F (-3.9°C)	25 %
20°F (-6.7°C)	30 %



**CAUTION:** When your application requires the use of glycol, use industrial grade glycol specifically designed for heat transfer systems and equipment. Never use glycol designed for automotive applications. Automotive glycols typically have additives engineered to benefit the materials and conditions found in an automotive engine; however, these additives can gel and foul heat exchange surfaces and result in loss of performance or even failure of the chiller. In addition, these additives can react with the materials of the pump shaft seals resulting in leaks or premature pump failures.



**WARNING:** Ethylene Glycol is flammable at higher temperatures in a vapor state. Carefully handle this material and keep away from open flames or other possible ignition sources.

### Step 3 - Check Condenser

There are two possible types of condensers present in the chiller: water-cooled and remote air-cooled. It is important to verify the chiller will have adequate condenser cooling for proper chiller operation.

#### Water-Cooled Condenser Check

Check the condenser water lines to make sure all connections are secure. Make sure sufficient condenser water flow and pressure are available, the condenser water supply is on, and all shut-off valves are open. The electronic water regulating valves ship in the closed position and opens after enabling the circuit.

#### Remote Air-Cooled Condenser Check

Check the refrigerant lines to make sure all connections are secure and the refrigeration is as described in the installation section of this manual. Check the remote condenser main power and control wiring to ensure all connections are secure.

### Step 4 – Check Refrigerant Valves

During shipment or installation it is possible valves were closed. Verify that all refrigerant valves are open.

### Step 5 – Check Low Temperature Alarm

Make sure the Low Temperature Alarm Set Point is set appropriately for the operating conditions of the chiller. The Low Temperature Alarm setting is in a password protected menu of the chiller controller. Refer to the control section of this manual for instructions on how to access this menu. The Low Temperature Alarm should be set at 10°F below the minimum chilled water temperature setting that the chiller will be operating. Also ensure the process coolant has sufficient freeze protection (glycol) to handle at least 5°F below the Low Temperature Alarm setting. All chillers are shipped from the factory with the Low Temperature Alarm set at 35°F. This is done to protect against a possible freeze-up if no glycol has been added to the coolant. Once the proper glycol solution has been added, the Low Temperature Alarm can be adjusted to the appropriate setting.



**CAUTION:** The manufacturer's warranty does not cover the evaporator from freezing. It is vital that the Freezestat is set properly.

### Step 6 – Turn On Control Power

Turn on the control power by turning the control power switch to "On". The panel displays should now be illuminated. Due to extreme ambient temperatures that the unit may be exposed to during shipment and installation, you may encounter a High Refrigerant Pressure alarm when you turn on the control power. If this is the case, reset the alarm. Do not proceed until all alarms have been reset and no further alarm conditions are present.

## Step 7 – Establish Coolant Flow

Establish flow through the chiller.

*Note: The compressor will not start as long as the flow switch is open. A positive flow must be established through the evaporator before the compressor can operate.*

Set water flow using a discharge throttling valve or flow control valve (by others). The valve should be the same size as the To Process connection of the chiller. Standard chillers are designed for approximately 2.4 gpm/ton of nominal capacity. A significant increase in flow beyond this in a standard chiller may result in excessive pressure loss and negatively impact chiller efficiency and in extreme cases may cause premature wear or damage of internal components.

## Step 8 – Initial Unit Operation

Enter the desired leaving fluid temperature on the chiller HMI. Unless otherwise specified, the chiller is factory set to deliver coolant at 50°F. Adjust to the desired operating temperature. The chiller should now be controlling to the selected temperature. Please note that if there is insufficient load the compressor may cycle on and off causing swings in temperature.



**WARNING:** Under no circumstance should the High Refrigerant Pressure or the Low Compressor Pressure switch be deactivated. Failure to heed this warning can cause serious compressor damage, severe personal injury or death.

Operate the system for approximately 30 minutes. Check the liquid line sight glass. The refrigerant flow past the sight glass should be clear. Bubbles in the refrigerant indicate either low refrigerant charge or excessive pressure drop in the liquid line. A shortage of refrigerant is indicated if operating pressures are low and subcooling is low. Normal subcooling ranges are from 10°F to 20°F. If subcooling is not within this range, check the superheat and adjust if required. The superheat should be approximately 10°F. If the operating pressures, sight glass, superheat, and subcooling readings indicate a refrigerant shortage, charge refrigerant as required. With the unit running, add refrigerant using industry best practices until operating conditions become normal.



**CAUTION:** A clear sight glass alone does not mean that the system is properly charged. Also check system superheat, subcooling, and unit operating pressures. If both suction and discharge pressures are low but subcooling is normal, a problem other than refrigerant shortage exists. Do not add refrigerant, as this may result in overcharging the circuit.

Once proper flow and temperature are achieved, press the Stop button. The unit is now ready to be placed into service.

## Preventive Maintenance

---

Once your chiller is in service, follow the maintenance procedures as closely as possible. Specific site conditions may require repeating certain tasks more frequently. The importance of a properly established preventive maintenance program cannot be overemphasized. Taking the time to follow these simple procedures will result in substantially reduced downtime, reduced repair costs, and an extended useful lifetime for the chiller. Any monetary costs of implementing these procedures will usually more than pay for itself.

To make this as simple as possible, prepare a checklist with the recommended service operations and record the date and time when performed. At the end of this manual, you will find a checklist for this purpose. Please notice that there are locations for voltage readings, amperages, etc. for monitoring over time. With this information, maintenance personnel may be able to correct a potential problem before it causes any downtime. For best results, take these readings with a full heat load from process, preferably with similar operating conditions each time. The following is a list of suggested periodic maintenance.

### Once a Week

1. Check to make sure that the To Process temperature is reasonably close to the Set Point temperature. If the temperature stays more than 5°F away from the set point, there may be a problem with the chiller. If this is the case, refer to the Troubleshooting Chart or contact our Customer Service Department.

2. Check and optional integral chiller and/or process pump discharge pressures. Investigate further if the pressure starts to stray away from the normal operating pressure.
3. Check the suction and discharge refrigerant pressure at the compressor.
4. Check each refrigerant sight glass for air bubbles or moisture indication. Bubbles in the refrigerant indicate either low refrigerant charge or excessive pressure drop in the liquid line. If the sight glass indicates that there is a refrigeration problem, have the unit serviced as soon as possible.
5. Check the compressor oil level in the sight glass. View the oil level through the sight glass while the compressor is running. The level will vary as the compressor loads and unloads.

### Once a Month

Repeat items 1 through 5 and continue with the following.

6. Check the Y strainer between the return connection and the evaporator inlet. Open the blow-down valve attached to the strainer to flush the screen free of debris.
7. Check the flow sensor tip visually for signs of build-up and clean with a soft cloth. Is there is some suborn calcium build-up that is not easily removed with a soft cloth use household vinegar as a cleaning agent to remove the deposit.
8. Shut off the power disconnect. Check the condition of electrical connections at all controls. Check for loose or frayed wires.
9. Check the main power supply to ensure it is acceptable, connected properly, and the unit has a proper ground (see Installation section of this manual for details).
10. Check the amp draws to each leg of the compressor(s) to confirm that it is drawing the proper current.

11. Check the system superheat and sub-cooling. Normal superheat is approximately 10°F; however, it may be high but not more than 15°F. Normal sub-cooling ranges from 10°F to 20°F.

### Once Every 6 Months

Repeat items 1 through 11 and continue with the following.

12. Check for visible mechanical damage to the compressor.
13. Check for excessive vibration from other rotating equipment.
14. Check for signs of hot spot/discoloration on power cables.
15. Check all communication cables are secure and tight.
16. Check all electrical modules are secure.
17. Check system refrigerant charge and verify the system is still full charged.
18. Check the operation of the compressor crankcase heater. Energize the heater while the compressor is off. Taking an amp reading of the heater leads is the best way to determine the correct operation. Another way is to feel if there is localized heat around the crankcase heater when the heater is on.

### Once a Year

Repeat items 1 through 18 and continue with the following.

19. Check the condition of the chilled water for algae and particulate fouling. Back flush the evaporator with water or another suitable cleaning agent. The frequency at which this task is required depends on specific site conditions.

20. (TSEW Models) Check the condition of the condenser water for algae, scale, and particulate fouling. Rod out the tubes and back flush the condensers. If scaling exists on the condenser tubes, chemical cleaning of the tubes may also be necessary. If a chemical cleaning agent is used, it should be suitable with the internal components composed of copper, steel, and cast iron. The frequency at which this task is required depends on specific site conditions.
21. (TSEW Models) Check the condition of the air coils of the remote condensers for dirt and debris. If the coils are dirty or clogged, use a compressed air source to blow the contaminants out of the air coil. The frequency at which this task is required depends on specific site conditions.
22. Have a qualified laboratory perform a compressor oil analysis to determine system moisture content and acid level.

## Cleaning the Operator Interface

Use of abrasive cleaners or solvents may damage the window. Do not scrub or use brushes. To clean the display window:

1. Disconnect power from the terminal at the power source.
2. Using a clean sponge or a soft cloth, clean the display with a mild soap or detergent. If paint or grease splash is present, remove before drying by rubbing lightly with isopropyl alcohol. Afterward, provide a final wash using a mild soap or detergent solution. Rinse with clean water.
3. Dry the display with a chamois or moist cellulose sponge to avoid water spots.

## General Troubleshooting

Problem	Possible Cause	Remedy
Compressor will not start	Three-phase power monitor tripped	Check correct phasing of incoming power
	Compressor overload	Check supply voltage, amperage of each leg, contactor and wiring, overload set point
	Compressor contactor	Replace if faulty
	PLC output card	Replace if faulty
	Compressor failure	Contact Customer Service Department for assistance
Low refrigerant pressure	Low refrigerant charge	Contact refrigeration service technician
	Refrigerant leak	Contact refrigeration service technician
	Compressor suction service valve partially or fully closed	Open valve all the way
	Low refrigerant pressure sensor	Replace if faulty
	PLC input card	Replace if faulty
	Fouled evaporator flow	Clean evaporator inlet strainer. Clean the evaporator. If clogged and not cleanable, replace if necessary.
	Low evaporator flow	Check evaporator pumping system
High refrigerant pressure	Plugged condenser	Clean condenser
	Insufficient condenser water flow (TSEW only)	Make sure chiller is installed in accordance with recommendations in this manual
	High condenser water temperature (TSEW only)	Maximum temperature is 95°F
	Condenser water regulating valve (TSEW only)	Replace if faulty
	Compressor discharge service valve is fully or partially closed	Open valve all the way
	Refrigerant circuit overcharged	Contact refrigeration service technician
	High refrigerant pressure sensor	Replace if faulty
	PLC input card	Replace if faulty
Freezestat	Low flow through evaporator	Adjust flow to proper level
	Freezestat control	Check for proper setting and replace if faulty
	Temperature sensor	Replace if faulty
	PLC input card	Replace if faulty
	Evaporator Y-strainer clogged or dirty	Clean Y-strainer
Insufficient cooling (temperature continues to rise above set point)	Process load too high	Check to make sure chiller is properly sized for process load
	Coolant flow outside of normal operating range	Adjust flow to proper level
	Insufficient condenser cooling	See high refrigerant pressure
	Refrigeration circuit problem	Contact refrigeration service technician
	Temperature sensor	Replace if faulty
	PLC input card	Replace if faulty
Erratic temperature control	Low coolant flow through evaporators	Adjust flow to proper level
	Overloading of chiller capacity	Check to make sure chiller is properly sized for process load
	Temperature sensor	Replace if faulty
	PLC input card	Replace if faulty

## Preventive Maintenance Checklist

The following is a sample of a typical dual-circuit chiller checklist.

Maintenance Activity	Week Number											
	1	2	3	4	5	6	7	8	9	10	11	12
Date												
Temperature Control												
Pump Discharge Pressure												
Refrigerant Suction Pressure #1												
Refrigerant Suction Pressure #2												
Refrigerant Discharge Pressure #1												
Refrigerant Discharge Pressure #2												
Refrigerant Sight Glass #1												
Refrigerant Sight Glass #2												
Check and clean evaporator Y-strainer												
Electrical Connections												
Incoming Voltage												
Compressor #1 L1 Amps												
Compressor #1 L2 Amps												
Compressor #1 L3 Amps												
Compressor #2 L1 Amps												
Compressor #2 L2 Amps												
Compressor #2 L3 Amps												
Compressor #3 L1 Amps												
Compressor #3 L2 Amps												
Compressor #3 L3 Amps												
Compressor #4 L1 Amps												
Compressor #4 L2 Amps												
Compressor #4 L3 Amps												
Refrigerant Circuit #1 Superheat												
Refrigerant Circuit #2 Superheat												
Refrigerant Circuit #1 Sub-cooling												
Refrigerant Circuit #2 Sub-cooling												
*Oil Level Check #1												
*Oil Level Check #2												
*Oil Analysis #1												
*Oil Analysis #2												

\* Once a year

## Drawings

We have prepared a custom set of drawings for your unit and placed them inside the control panel prior to shipment. Please refer to these drawings when troubleshooting, servicing, and installing the unit. If you cannot find these drawings or wish to have additional copies sent, please contact our Customer Service Department and reference the serial number of your unit.











5680 W. Jarvis Ave. • Niles, IL 60714  
847.966.2260  
[www.thermalcare.com](http://www.thermalcare.com)

**New Equipment Sales**  
847.966.2260  
[sales@thermalcare.com](mailto:sales@thermalcare.com)

**Customer Service**  
847.966.2636  
[tcservice@thermalcare.com](mailto:tcservice@thermalcare.com)

**Parts Department**  
847.966.8560  
[tcparts@thermalcare.com](mailto:tcparts@thermalcare.com)