



Portable & Packaged Chillers

OPERATION,
INSTALLATION AND
MAINTENANCE
MANUAL

Accuchiller NQ



Where water
means business.



Table of Contents

Foreword.....	1
Safety Guidelines	1
Pre-Installation.....	2
Receiving Inspection	2
Unit Storage.....	2
Installation - Chiller	3
Foundation.....	3
Unit Location.....	3
Rigging	3
Chilled Process Fluid Piping	3
Figure 1 – Recommended Overhead Piping.....	3
Condenser Water Piping.....	3
Installation – Remote Condenser	4
Location.....	4
Lifting	4
Mounting Legs	4
Figure 2 - Mounting Remote Condenser Legs	4
Interconnecting Refrigerant Piping.....	4
Refrigeration Piping Design	5
Figure 3 – Condenser Located at Chiller Level.....	5
Figure 4 – Condenser Located Above Chiller Unit	5
Figure 5 - Condenser Located Below Chiller Unit.....	5
Determining Equivalent Line Length	6
Table 1 – Equivalent Lengths of Elbows	6
Liquid Line Sizing.....	6
Table 2 – Liquid Line Sizes for R410A and R454B	7
Discharge (Hot Gas) Line Sizing.....	9
Figure 6 – Vertical Riser Traps	9
Figure 7 - Double Discharge Riser.....	9
Table 3 - Horizontal or Downflow Discharge Line Sizes for R410A and R454B (inches OD)	10
Table 4 - Upflow Discharge Line Sizes for R410A and R454B (inches OD)	10
Calculating Refrigerant and Oil Charge.....	11
Table 5 – Chiller & Condenser Refrigerant Charge.....	11
Table 6 - Field Piping R-410A Refrigerant Charges	11
Oil Charge Determination.....	11
Setting Condenser Fan Controls.....	11
Table 7 - Condenser Fan Pressure Settings (psig).....	11
Figure 8 – Remote Condenser Fan Control Settings	11
Installation - Electrical.....	12
Control Operation	13
Screen Navigation.....	13
System Initialization.....	13
Figure 9 - Start-Up Screen	13
Home Screen.....	14
Figure 10 - Home Overview Screen	14
Menu 1 - Overview	14

Figure 11 - Overview Screen 1	14
Figure 12 - Overview Screen 2	14
Menu 1 - Alarms	14
Figure 13 - HMI Alarm Handler Screen	14
Menu 1 – Diagnostics	15
Figure 14 - Main Diagnostics Screen	15
Figure 15 - Diagnostics Screen 1 - Circuit 1 Overview	15
Figure 16 - Diagnostics Screen 2 – Circuit 1 Interlocks	15
Figure 17 - Diagnostics Screen 3 - Pumps	15
Figure 18 - Diagnostics Screen 4 - Process	15
Figure 19 - Diagnostics Screen 5 - Hardware	15
Menu 1 – Security	16
Figure 20 - Main Security Screen	16
Figure 21 - Security – Log In Screen	16
Figure 22 - Security – Add User Screen	16
Figure 23 - Security - Edit User Screen	16
Figure 24 - Security - Delete User Screen	17
Figure 25 - Security - Change Password Screen	17
Menu 1 – Input/Output	17
Figure 26 - Main Inputs/Outputs Screen	17
Figure 27 - Inputs/Outputs – Temperature Inputs Screen	17
Figure 28 - Inputs/Outputs – Pressure Inputs	17
Figure 29 - Inputs/Outputs – Analog Inputs Screen	18
Figure 30 - Inputs/Outputs – Digital Inputs Screen	18
Figure 31 - Inputs/Outputs – Analog Outputs Screen	18
Figure 32 - Inputs/Outputs – Digital Outputs Screen	18
Menu 1 – User Setup	18
Figure 33 - User Setup Menu - Screen 1	18
Figure 34 - User Setup Menu - Screen 2	18
Figure 35 - User Setup Menu - Screen 3	18
Figure 36 - User Setup – Alarm Setup Screen	19
Figure 37 - User Setup – Hot Gas Bypass Screen	19
Figure 38 - User Setup – Pumps Screen	19
Figure 39 - User Setup – Process Pump VFD Screen	19
Figure 40 - User Setup – EEV Control Screen	19
Figure 41 - User Setup – Staging Screen	19
Figure 42 - User Setup – Stage Order Screen	19
Figure 43 - User Setup – Discharge Control Screen 1	19
Figure 44 - User Setup – Discharge Control Screen 2	20
Figure 45 - User Setup – Modbus RTU Screen	20
Figure 46 - User Setup – Process Temperature Retransmit Screen	20
Figure 47 - User Setup – Variable Speed Compressor Screen	20
Figure 48 - User Setup – IP Address Screen	20
Figure 49 - User Setup – Units Screen	20
Figure 50 - User Setup – 3-Way Mod Valve Screen	20
Figure 51 - User Setup – Misc Menu Screen	20
Figure 52 - User Setup – Evaporator Valve Control Screen	21
Figure 53 - User Setup – Chiller Tank Screen	21
Figure 54 - User Setup – Short Cycle Enabled Screen	21
Figure 55 - User Setup – Short Cycle Disabled Screen	21
Menu 1 – Trending	21

Figure 56 - System Trending Screen.....	21
Menu 2 – Full Screen.....	21
Figure 57 - Menu 2 – Full Screen	21
Menu 2 – System Build.....	21
Figure 58 - Review System Build Screen	22
Communications.....	23
Table 8 – Modbus Table	23
Table 9 – BACNet Parameters	27
Start-Up	32
Step 1 - Connect Main Power	32
Step 2 - Fill Coolant Circuit.....	32
System Fill Water Chemistry Requirements	32
Table 10 – Fill Water Chemistry Requirements.....	33
Table 11 - Recommended Glycol Solutions.....	33
Step 3 - Check Condenser	34
Integral Air-Cooled Condenser Check	34
Water-Cooled Condenser Check.....	34
Remote Air-Cooled Condenser Check.....	34
Step 4 – Check Refrigerant Valves.....	34
Step 5 – Verify Freezestat Setting	34
Step 6 – Turn On Control Power	34
Step 7 – Establish Coolant Flow.....	34
Step 8 – Intial Unit Operation.....	34
Preventive Maintenance.....	35
Once a Week	35
Once a Month.....	35
Every Three Months.....	35
Preventive Maintenance Checklist	36
General Troubleshooting.....	37
Drawings.....	38

Page Intentionally Blank

Foreword

The portable chiller is a packaged unit that typically includes a refrigeration circuit, coolant reservoir, and pumping system in a cabinet. The purpose is to cool water or a process fluid.

This manual is a guide for installing, operating, and maintaining the equipment. Improper installation, operation, and maintenance can lead to poor performance and/or equipment damage.

The information in this manual is general in nature. Unit-specific drawings and supplemental documents are included with the equipment as needed. Additional copies of documents are available upon request.

Due to the ever-changing nature of applicable codes, ordinances, and other local laws pertaining to the use and operation of this equipment, we do not reference them in this manual.

The equipment uses either a hydrofluorocarbon (HFC), trade named R-410A, or a hydrofluorolefin (HFO), trade named R-454B, as a chemical refrigerant for heat transfer purposes. R-454B is an A2L refrigerant, often referred to as "mildly flammable", and must be handled properly. No other refrigerant can be used in the system, nor can the refrigerants be mixed. This chemical is sealed and tested in a pressurized system containing ASME coded vessels; however, a system failure will release it. Refrigerant gas can cause toxic fumes if exposed to fire. Place these units in a well-ventilated area, especially if open flames are present. Failure to follow these instructions could result in a hazardous condition. Use a refrigerant management program to document the type and quantity of refrigerant in the equipment. Only allow licensed and EPA certified service technicians to work on refrigeration circuits.

Safety Guidelines

Observe all safety precautions during installation, start-up, and service of this equipment. The following is a list of symbols used in this manual and their meaning.



General Warning



Electricity Warning



Sharp Element Warning



Hot Surface Warning



Flammable Material Warning



Explosive Material Warning



General Mandatory Action



Wear Eye Protection



Wear Protective Gloves



Wear Ear Protection



Disconnect Before Carrying Out Maintenance or Repair



Connect an Earth Terminal to Ground

Only qualified personnel should install, start-up, and service this equipment. When working on this equipment, observe precautions in this manual as well as tags, stickers, and labels on the equipment.



WARNING: Any use of this equipment outside of the design intent may cause injury or harm.



WARNING: Vent all refrigerant relief valves in accordance to ANSI/ASHRAE Standard 15, Safety Code for Mechanical Refrigeration. Locate this equipment in a well-ventilated area. Inhalation of refrigerant can be hazardous to your health and the accumulation of refrigerant within an enclosed space can displace oxygen and cause suffocation.



WARNING: This equipment contains hazardous voltages that can cause severe injury or death.



WARNING: This equipment contains refrigerant under pressure. Accidental release of refrigerant under pressure can cause personal injury and or property damage.



WARNING: This equipment may contain fan blades or other sharp edges. Make sure all fan guards and other protective shields are securely in place.



WARNING: The exposed surfaces of motors, refrigerant piping, and other fluid circuit components can be very hot and can cause burns if touched with unprotected hands.



CAUTION: Disconnect and lock out incoming power before installing, servicing, or maintaining the equipment. Connecting power to the main terminal block energizes the entire electric circuitry of the unit. Shut off the electric power at the main disconnect before opening access panels for repair or maintenance.



CAUTION: Wear eye protection when installing, maintaining, or repairing the equipment to protect against any sparks, debris, or fluid leaks.



CAUTION: The equipment will exceed 70 dBA sound pressure at 1 meter distance and 1 meter elevation when operating. Wear ear protection as required for personal comfort when operating or working in close proximity to the chiller.



CAUTION: Wear protective gloves when installing, maintaining, or repairing the equipment to protect against any sparks, debris, or fluid leaks.

Pre-Installation

Receiving Inspection

When the unit arrives, verify the information on the unit nameplate agrees with the order acknowledgement and shipping papers. Inspect all items for visible damage. If damage is evident, document it on the delivery receipt by marking any item with damage as "unit damage" and notify the carrier and our Customer Service Department. Do not install damaged equipment without approval from our Customer Service Department.

To protect against loss due to damage incurred during shipping it is important to follow proper procedures and keep records. When unpacking equipment inspect for concealed damage and take pictures of any damage found. Once received, equipment owners have the responsibility to provide reasonable evidence that the damage did not occur after delivery. Photos of damage while the equipment is still partially packed helps in this regard.

Chillers with an integral water-cooled or air-cooled condenser ship with a full refrigerant charge. Chillers designed for use with a remote air-cooled condenser and the remote condensers themselves ship with a nitrogen holding charge.

Unit Storage

When storing the unit, it is important to protect it from damage. Blow out any water from the unit; cover it to keep dirt and debris from accumulating or getting in, and store in an indoor sheltered area that remains between 40°F and 140°F.

Installation - Chiller

Foundation

Install the chiller on a rigid, non-warping mounting pad, concrete foundation, or level floor suitable to support the full operating weight of the equipment. When installed the equipment must be level within ¼ inch over its length and width.

Unit Location

To ensure proper airflow and space for maintenance allow a minimum of 36 inches of clearance between the sides of the equipment and any walls or obstructions. Avoid locating piping or conduit over the unit to ensure easy crane access of heavier components during replacement or service. Make sure all refrigerant pressure relief valves can vent in accordance with all local and national codes.

Air-cooled chillers use the surrounding air for cooling the condenser and require free passage of air in and out of the chiller. Locate the chiller in an area that allows for removal of the warm air from the area.

Rigging

The chiller has a cabinet with casters or feet and a frame to facilitate easy movement and positioning with a crane or forklift. Follow proper rigging methods to prevent damage to components. Avoid impact loading caused by sudden jerking when lifting or lowering the chiller. Use pads where abrasive surface contact may occur.

Chilled Process Fluid Piping

Proper insulation of chilled process fluid piping is crucial to prevent condensation. The formation of condensation adds a substantial heat load to the chiller.

The importance of properly sized piping cannot be overemphasized. See the ASHRAE Handbook or other suitable design guide for proper pipe sizing. In general, run full size pipe to the process and only reduce pipe size at connections as needed. One of the most common causes of unsatisfactory chiller performance is poor piping system design. Avoid long lengths of hoses, quick disconnect fittings, and manifolds wherever possible as they offer high resistance to water flow. When manifolds are

required, install them as close to the use point as possible. Provide flow-balancing valves at each machine to assure adequate water distribution in the entire system. When piping is overhead with a total run over 90 feet, install a valve in the supply line and an inverted P trap with a vacuum break valve installed as shown in Figure 1.

Figure 1 – Recommended Overhead Piping

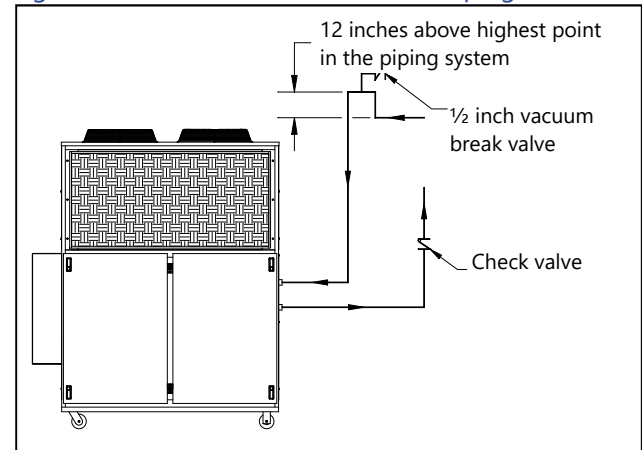

Nominal coolant flow rates assume a 10°F rise across the evaporator at 50°F set point and 85°F entering condenser water for water-cooled chillers or 95°F entering air for integral air-cooled or remote air-cooled condenser chillers.

Install a throttling valve or flow control valve on the discharge line to allow for adjustment of the flow of process fluid through the chiller. The valve should be the same size as the To Process connection of the chiller.

Condenser Water Piping

(Water-Cooled Condenser Chillers Only)

The performance of a water-cooled condenser chiller depends on proper flow and temperature of the condenser cooling water. Insufficient cooling of the condenser will result in the reduction of cooling capacity and under extreme conditions could result in a high refrigerant pressure alarm. Contaminants in the condenser water stream or scale formation will lead to poor performance and the potential for unwanted downtime.

The nominal water-cooled condenser requires 85°F condenser water supply. Under normal operation there will be about a 10°F rise through the condenser resulting in 95°F exiting water. To

maintain proper flow through the condenser, ensure the condenser water pump supply provide at least 25 psi at a flow of 3 gpm per ton of chiller capacity.

The condenser has a two-way condenser water-regulating valve to control the amount of water passing through the condenser, which in turn maintains the refrigeration pressures in the circuit. To prevent damage to the condenser and/or water-regulating valve, the water pressure should not exceed 150 psig.

Installation – Remote Condenser

Chillers with a remote air-cooled condenser include a factory-selected remote condenser. The remote air-cooled condenser typically ships separately from a different location than the chiller.

The condenser ships on its side with the legs removed to reduce shipping dimensions and provide more protection to the coil from possible damage caused by impact loading over rough roads and transit conditions.

Location

The condenser is for outdoor use. Locate the remote condenser in an accessible area with enough space to allow for easy maintenance and operation. Avoid locating piping or conduit over the unit to ensure easy access with an overhead crane or lift to lift out heavier components during replacement or service.

The vertical air discharge must be unobstructed. Allow a minimum of 48 inches of clearance on all sides of the condenser. For installations with multiple condensers, allow a minimum of 96 inches between condensers placed side-by-side or 48 inches for condensers placed end-to-end.

Proper ventilation is important. Locate the condenser in an area that will not rise above 110°F. Avoid areas such as an alcove with east, north, and west walls that can be significantly warmer than surrounding areas. Locate the condenser where fan noise and vibration transmission into nearby workspaces is unlikely.

Install the condenser on a firm, level surface. Avoid locations near exhaust fans, plumbing vents, flues, or chimneys. Fasten the mounting legs at their base to the steel or concrete of the supporting structure.

Lifting

Use qualified personnel when lifting and positioning the condenser. Lifting brackets or holes are at the corners for attaching lifting slings. Use spreader bars when lifting to apply the lifting force vertically. Under no circumstances use the coil headers or return bends in the lifting or moving of the condenser.

Mounting Legs

Assemble the corner legs to the bottom flanges on the unit side panels and end panels using the hardware provided and the matching mounting hole-patterns. All corner legs are the same. For units that are longer than three fans, assemble the center leg. Remove two bolts from the bottom flange of the unit side panels that match the hole-pattern on the top flanges of both legs. Attach the center legs using the hardware provided at the center-divider panel location. Replace the bolts removed from the side panels to secure the leg assembly to the bottom flanges of the condenser side panels.

Figure 2 - Mounting Remote Condenser Legs

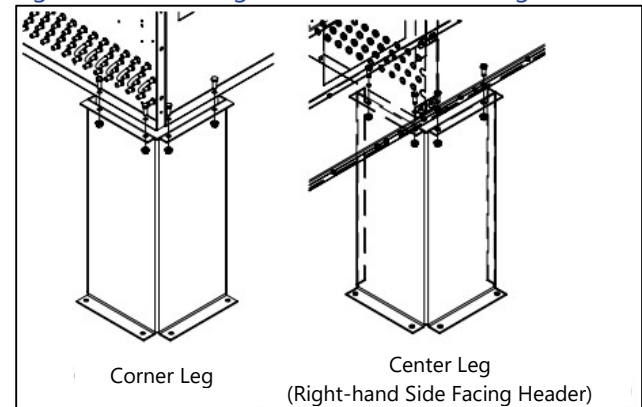

Interconnecting Refrigerant Piping

The chiller and remote condenser ship with a nitrogen holding charge. Evacuate this charge before charging with refrigerant.

The discharge and liquid lines leaving the chiller have caps. These line sizes do not necessarily reflect the actual line sizes required for the piping between the chiller and the air-cooled condenser. Refrigerant piping size and piping design have a significant impact on system performance and reliability. All piping should conform to the applicable local and state codes.



CAUTION: Only use refrigerant grade copper tubing ASTM B280 and isolate the refrigeration lines from building structures to prevent transfer of vibration. All copper tubing must have a pressure rating suitable for R-410A: tubing that is 3/4" OD or larger must be Type K rigid tubing. ACR annealed tubing coil may be used for sizes 5/8" ODS or smaller.

Use a tube cutter or heat to remove the caps. When sweating copper joints evacuate all refrigerant present and flow dry nitrogen through the system. This prevents the formation of toxic gases, corrosive acids, and scale.



CAUTION: Do not use soft solders. For copper-to-copper joints use a copper-phosphorus braze alloy (BCuP per the American Welding Society) with 5% (BCuP-3) to 15% (BCuP-5) silver content. Only use a high silver content brazing alloy (BAg per AWS) for copper-to-brass or copper-to-steel joints such as a 45% (BAg-5) silver content. Only use oxy-acetylene brazing.



WARNING: The POE oil contained within the compressor is hygroscopic and has the ability to absorb water vapor from the atmosphere. Take necessary steps to prevent an open system from exposure to the atmosphere for extended periods while installing the interconnecting refrigerant tubing.

Refrigeration Piping Design

The system is configurable in any of the arrangements as shown in Figure 3, Figure 4, and Figure 5. The configuration and its associated elevation, along with the total distance between the chiller and the condenser are important factors in determining the liquid line and discharge line sizes and refrigerant charge.

General design considerations:

1. The total distance between the chiller and the condenser must not exceed 200 actual feet or 300 equivalent feet.
2. Liquid line risers must not exceed 15 feet in height from the condenser liquid line connection.

3. Discharge line risers cannot exceed an elevation difference greater than 100 actual feet without a minimum of 2% efficiency decrease.
4. To form a proper liquid seal at the condenser, immediately drop at least 15 inches down from the liquid outlet before routing the piping to the chiller. Make the drop leg before any bends or angles connecting to the remainder of the liquid connection piping.

Figure 3 – Condenser Located at Chiller Level

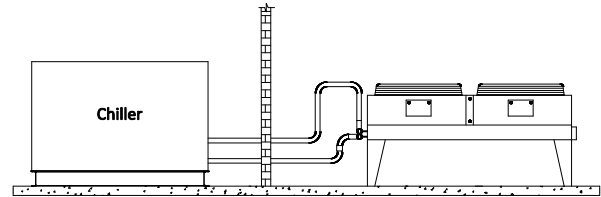

Figure 4 – Condenser Located Above Chiller Unit

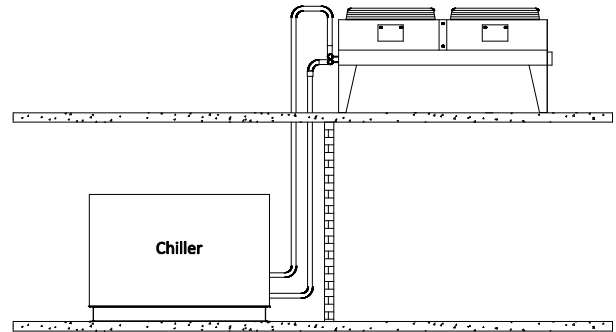
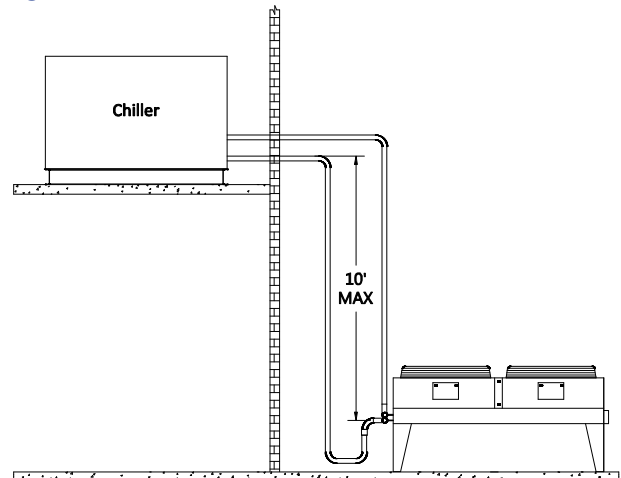

Figure 5 - Condenser Located Below Chiller Unit



Caution: Liquid line sizing for each chiller capacity is in Table 2. These line sizes are listed per circuit and apply where leaving water temperature (LWT) is 40°F or higher. For applications where the LWT is below 40°F, size lines using the ASHRAE Refrigeration Handbook or other suitable design guide.

Determining Equivalent Line Length

The equivalent length is the approximate friction loss from the combined linear run of pipe and the equivalent feet of elbows, valves, and other components in the refrigeration piping. The sum total is the equivalent length of pipe that would have the same pressure loss. See the ASHRAE Refrigeration Handbook for more information.

Follow these steps when calculating line size:

1. Start with an initial approximation of equivalent length by assuming that the equivalent length of pipe is 1.5 times the actual pipe length.
2. Determine approximate line sizes by referring to Table 2 for liquid lines, Table 3 and Table 4 for the discharge lines.
3. Check the line size by calculating the actual equivalent length using the equivalent lengths as shown in Table 1.



CAUTION: When calculating the equivalent length, do not include piping of the chiller unit. Only field piping must be considered.

Table 1 – Equivalent Lengths of Elbows

Line Size OD (in)	Equivalent Lengths of Refrigerant Pipe (feet)				
	90° Standard	90° Long Radius	90° Street	45° Standard	45° Street
7/8	2.0	1.4	3.2	0.9	1.6
1 1/8	2.6	1.7	4.1	1.3	2.1
1 3/8	3.3	2.3	5.6	1.7	3.0
1 5/8	4.0	2.6	6.3	2.1	3.4
2 1/8	5.0	3.3	8.2	2.6	4.5
2 5/8	6.0	4.1	10.0	3.2	5.2
3 1/8	7.5	5.0	12.0	4.0	6.4
3 5/8	9.0	5.9	15.0	4.7	7.3
4 1/8	10.0	6.7	17.0	5.2	8.5

Liquid Line Sizing

To keep the system refrigerant charge at a minimum, use the smallest acceptable line size possible. The total length between the chiller and the condenser must not exceed 200 actual feet or 300 equivalent feet. Pipe the liquid line so there is an immediate drop of at least 15 inches at the condenser outlets to make a liquid seal.

Liquid line risers in the system require an additional 0.5 psig pressure drop per foot of vertical rise. When it is necessary to have a liquid line riser, make the vertical run immediately after the condenser before any additional restrictions. The liquid line risers must not exceed 10 feet in height from the condenser liquid line connection. The liquid line does not require pitching. Install a pressure tap valve at the condenser to facilitate measuring pressure for service.

Liquid lines do not typically require insulation; however, if exposing the lines to solar heat gain or temperatures exceeding 110 °F, insulate the lines to avoid a negative effect on sub-cooling.

Table 2 – Liquid Line Sizes for R410A and R454B

5 Ton Circuit Liquid Line Size (Inch OD)					7½ Ton Circuit Liquid Line Size (Inch OD)				
Equivalent Length (Ft)	Horizontal or Down Flow	Up Flow (Feet of Run)			Equivalent Length (Ft)	Horizontal or Down Flow	Up Flow (Feet of Run)		
		0 to 5	6 to 10	11 to 15			0 to 5	6 to 10	11 to 15
25	1/2	1/2	1/2	1/2	25	5/8	5/8	5/8	5/8
50	1/2	1/2	1/2	5/8	50	5/8	5/8	5/8	5/8
75	1/2	1/2	1/2	5/8	75	5/8	5/8	5/8	3/4
100	1/2	1/2	5/8	5/8	100	5/8	5/8	5/8	3/4
125	1/2	1/2	5/8	3/4	125	5/8	5/8	3/4	3/4
150	1/2	5/8	5/8	3/4	150	5/8	5/8	3/4	7/8
175	5/8	5/8	5/8	3/4	175	5/8	5/8	3/4	7/8
200	5/8	5/8	5/8	3/4	200	5/8	3/4	3/4	7/8
225	5/8	5/8	5/8	3/4	225	5/8	3/4	3/4	7/8
250	5/8	5/8	5/8	3/4	250	5/8	3/4	3/4	7/8
275	5/8	5/8	3/4	3/4	275	3/4	3/4	3/4	7/8
300	5/8	5/8	3/4	7/8	300	3/4	3/4	3/4	7/8
10 Ton Circuit Liquid Line Size (Inch OD)					15 Ton Circuit Liquid Line Size (Inch OD)				
Equivalent Length (Ft)	Horizontal or Down Flow	Up Flow (Feet of Run)			Equivalent Length (Ft)	Horizontal or Down Flow	Up Flow (Feet of Run)		
		0 to 5	6 to 10	11 to 15			0 to 5	6 to 10	11 to 15
25	3/4	3/4	3/4	3/4	25	7/8	7/8	7/8	7/8
50	3/4	3/4	3/4	3/4	50	7/8	7/8	7/8	7/8
75	3/4	3/4	3/4	3/4	75	7/8	7/8	7/8	7/8
100	3/4	3/4	3/4	7/8	100	7/8	7/8	7/8	1 1/8
125	3/4	3/4	3/4	7/8	125	7/8	7/8	7/8	1 1/8
150	3/4	3/4	3/4	7/8	150	7/8	7/8	7/8	1 1/8
175	3/4	3/4	3/4	7/8	175	7/8	7/8	7/8	1 1/8
200	3/4	3/4	7/8	1 1/8	200	7/8	7/8	1 1/8	1 1/8
225	3/4	3/4	7/8	1 1/8	225	7/8	7/8	1 1/8	1 1/8
250	3/4	3/4	7/8	1 1/8	250	7/8	7/8	1 1/8	1 1/8
275	3/4	3/4	7/8	1 1/8	275	7/8	7/8	1 1/8	1 1/8
300	3/4	7/8	7/8	1 1/8	300	7/8	7/8	1 1/8	1 1/8

Table 2 – Liquid Line Sizes for R410A and R454B (continued)

20 Ton Circuit Liquid Line Size (Inch OD)					25 Ton Circuit Liquid Line Size (Inch OD)				
Equivalent Length (Ft)	Horizontal or Down Flow	Up Flow (Feet of Run)			Equivalent Length (Ft)	Horizontal or Down Flow	Up Flow (Feet of Run)		
		0 to 5	6 to 10	11 to 15			0 to 5	6 to 10	11 to 15
25	1 1/8	1 1/8	1 1/8	1 1/8	25	1 1/8	1 1/8	1 1/8	1 1/8
50	1 1/8	1 1/8	1 1/8	1 1/8	50	1 1/8	1 1/8	1 1/8	1 1/8
75	1 1/8	1 1/8	1 1/8	1 1/8	75	1 1/8	1 1/8	1 1/8	1 1/8
100	1 1/8	1 1/8	1 1/8	1 1/8	100	1 1/8	1 1/8	1 1/8	1 1/8
125	1 1/8	1 1/8	1 1/8	1 1/8	125	1 1/8	1 1/8	1 1/8	1 1/8
150	1 1/8	1 1/8	1 1/8	1 1/8	150	1 1/8	1 1/8	1 1/8	1 3/8
175	1 1/8	1 1/8	1 1/8	1 1/8	175	1 1/8	1 1/8	1 1/8	1 3/8
200	1 1/8	1 1/8	1 1/8	1 3/8	200	1 1/8	1 1/8	1 1/8	1 3/8
225	1 1/8	1 1/8	1 1/8	1 3/8	225	1 1/8	1 1/8	1 1/8	1 3/8
250	1 1/8	1 1/8	1 1/8	1 3/8	250	1 1/8	1 1/8	1 1/8	1 3/8
275	1 1/8	1 1/8	1 1/8	1 3/8	275	1 1/8	1 1/8	1 1/8	1 3/8
300	1 1/8	1 1/8	1 1/8	1 3/8	300	1 1/8	1 1/8	1 3/8	1 3/8
30 Ton Circuit Liquid Line Size (Inch OD)					35 Ton Circuit Liquid Line Size (Inch OD)				
Equivalent Length (Ft)	Horizontal or Down Flow	Up Flow (Feet of Run)			Equivalent Length (Ft)	Horizontal or Down Flow	Up Flow (Feet of Run)		
		0 to 5	6 to 10	11 to 15			0 to 5	6 to 10	11 to 15
25	1 1/8	1 1/8	1 1/8	1 1/8	25	1 3/8	1 3/8	1 3/8	1 3/8
50	1 1/8	1 1/8	1 1/8	1 1/8	50	1 3/8	1 3/8	1 3/8	1 3/8
75	1 1/8	1 1/8	1 1/8	1 1/8	75	1 3/8	1 3/8	1 3/8	1 3/8
100	1 1/8	1 1/8	1 1/8	1 3/8	100	1 3/8	1 3/8	1 3/8	1 3/8
125	1 1/8	1 1/8	1 1/8	1 3/8	125	1 3/8	1 3/8	1 3/8	1 3/8
150	1 1/8	1 1/8	1 1/8	1 3/8	150	1 3/8	1 3/8	1 3/8	1 3/8
175	1 1/8	1 1/8	1 1/8	1 3/8	175	1 3/8	1 3/8	1 3/8	1 3/8
200	1 1/8	1 1/8	1 1/8	1 3/8	200	1 3/8	1 3/8	1 3/8	1 5/8
225	1 1/8	1 1/8	1 3/8	1 3/8	225	1 3/8	1 3/8	1 3/8	1 5/8
250	1 1/8	1 1/8	1 3/8	1 5/8	250	1 3/8	1 3/8	1 3/8	1 5/8
275	1 1/8	1 1/8	1 3/8	1 5/8	275	1 3/8	1 3/8	1 3/8	1 5/8
300	1 1/8	1 1/8	1 3/8	1 5/8	300	1 3/8	1 3/8	1 3/8	1 5/8

Table 2 – Liquid Line Sizes for R410A and R454B
(continued)

40 Ton Circuit Liquid Line Size (Inch OD)				
Equivalent Length (Ft)	Horizontal or Down Flow	Up Flow (Feet of Run)		
		0 to 5	6 to 10	11 to 15
25	1 3/8	1 3/8	1 3/8	1 3/8
50	1 3/8	1 3/8	1 3/8	1 3/8
75	1 3/8	1 3/8	1 3/8	1 3/8
100	1 3/8	1 3/8	1 3/8	1 3/8
125	1 3/8	1 3/8	1 3/8	1 3/8
150	1 3/8	1 3/8	1 3/8	1 5/8
175	1 3/8	1 3/8	1 3/8	1 5/8
200	1 3/8	1 3/8	1 3/8	1 5/8
225	1 3/8	1 3/8	1 3/8	1 5/8
250	1 3/8	1 3/8	1 3/8	1 5/8
275	1 3/8	1 3/8	1 3/8	1 5/8
300	1 3/8	1 3/8	1 3/8	1 5/8

Discharge (Hot Gas) Line Sizing

The discharge line size depends on the velocity needed to obtain sufficient oil return. It is very important to minimize line length and restrictions to reduce pressure drop and maximize capacity.

Upflow hot gas risers require a trap at the bottom and a reverse trap at the top. In addition, install a trap and a reverse trap arrangement spaced every 15 feet in the rise for oil management (see Figure 6).

Pitch the discharge lines downward, in the direction of the hot gas flow, at the rate of 1/2 inch per each 10 foot of horizontal run. If the chiller is below the condenser, loop the discharge line to at least 1 inch above the top of the condenser. Install a pressure tap valve at the condenser to facilitate measuring pressure for service.

Check the oil-level sight glass in the compressor to ensure it is at the appropriate level to verify there is no trapping of oil in the piping. Use a double riser system to ensure proper oil return under low load operation. See Figure 7 and Table 4 for double riser constructions.

Figure 6 – Vertical Riser Traps

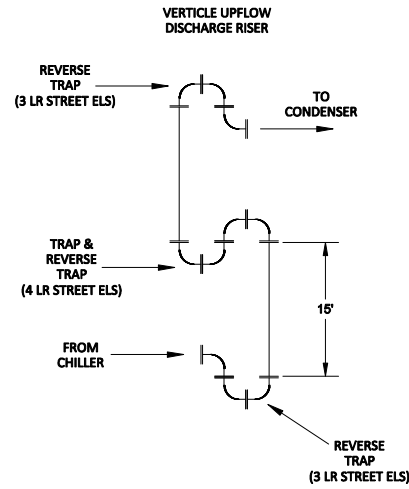
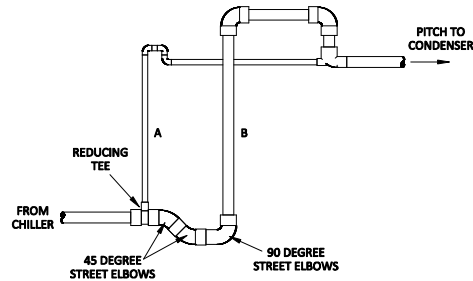

Figure 7 - Double Discharge Riser



Note: Discharge line sizing shown in Table 3 and Table 4 are listed per circuit and apply where leaving water temperature (LWT) is 40°F or higher. For applications where LWT is below 40°F, size lines using the ASHRAE Refrigeration Handbook or other suitable design guide.

Table 3 - Horizontal or Downflow Discharge Line Sizes for R410A and R454B (inches OD)

Circuit Tons	Total Equivalent Length (Ft)											
	25	50	75	100	125	150	175	200	225	250	275	300
5	5/8	5/8	5/8	5/8	3/4	3/4	3/4	3/4	3/4	3/4	3/4	7/8
7.5	7/8	7/8	7/8	7/8	7/8	7/8	7/8	7/8	7/8	7/8	7/8	7/8
10	7/8	7/8	7/8	7/8	7/8	7/8	7/8	1 1/8	1 1/8	1 1/8	1 1/8	1 1/8
15	7/8	7/8	1 1/8	1 1/8	1 1/8	1 1/8	1 1/8	1 1/8	1 1/8	1 1/8	1 3/8	1 3/8
20	7/8	1 1/8	1 1/8	1 3/8	1 3/8	1 3/8	1 3/8	1 3/8	1 3/8	1 3/8	1 5/8	1 5/8
25	1 1/8	1 1/8	1 1/8	1 3/8	1 3/8	1 3/8	1 3/8	1 3/8	1 3/8	1 3/8	1 5/8	1 5/8
30	1 1/8	1 1/8	1 1/8	1 3/8	1 3/8	1 3/8	1 3/8	1 3/8	1 3/8	1 5/8	1 5/8	1 5/8
35	1 3/8	1 3/8	1 3/8	1 5/8	1 5/8	1 5/8	1 5/8	2 1/8	2 1/8	2 1/8	2 1/8	2 1/8
40	1 5/8	1 5/8	1 5/8	1 5/8	1 5/8	1 5/8	2 1/8	2 1/8	2 1/8	2 1/8	2 1/8	2 1/8

Table 4 - Upflow Discharge Line Sizes for R410A and R454B (inches OD)

Circuit Tons	Total Equivalent Length (Ft)											
	25	50	75	100	125	150	175	200	225	250	275	300
5	A - 3/8	A - 3/8	A - 3/8	A - 3/8	A - 3/8	A - 3/8	A - 3/8	A - 3/8	A - 3/8	A - 3/8	A - 3/8	A - 3/8
	B - 1/2	B - 1/2	B - 1/2	B - 1/2	B - 5/8	B - 5/8	B - 5/8	B - 5/8	B - 5/8	B - 5/8	B - 5/8	B - 3/4
7.5	A - 3/8	A - 3/8	A - 3/8	A - 3/8	A - 3/8	A - 3/8	A - 3/8	A - 3/8	A - 3/8	A - 3/8	A - 3/8	A - 3/8
	B - 3/4	B - 3/4	B - 3/4	B - 3/4	B - 3/4	B - 3/4	B - 3/4	B - 3/4	B - 3/4	B - 3/4	B - 3/4	B - 3/4
10	A - 3/8	A - 3/8	A - 3/8	A - 3/8	A - 3/8	A - 3/8	A - 3/8	A - 3/8	A - 3/8	A - 3/8	A - 3/8	A - 3/8
	B - 3/4	B - 3/4	B - 3/4	B - 3/4	B - 3/4	B - 3/4	B - 3/4	B - 7/8	B - 7/8	B - 7/8	B - 7/8	B - 7/8
15	A - 3/8	A - 3/8	A - 3/8	A - 3/8	A - 3/8	A - 3/8	A - 3/8	A - 3/8	A - 3/8	A - 3/8	A - 1/2	A - 1/2
	B - 3/4	B - 3/4	B - 7/8	B - 7/8	B - 7/8	B - 7/8	B - 7/8	B - 7/8	B - 7/8	B - 7/8	B - 1 1/8	B - 1 1/8
20	A - 3/8	A - 3/8	A - 3/8	A - 1/2	A - 1/2	A - 1/2	A - 1/2	A - 1/2	A - 1/2	A - 1/2	A - 5/8	A - 5/8
	B - 3/4	B - 7/8	B - 7/8	B - 1 1/8	B - 1 1/8	B - 1 1/8	B - 1 1/8	B - 1 1/8	B - 1 1/8	B - 1 1/8	B - 1 3/8	B - 1 3/8
25	A - 3/8	A - 3/8	A - 3/8	A - 1/2	A - 1/2	A - 1/2	A - 1/2	A - 1/2	A - 1/2	A - 1/2	A - 5/8	A - 5/8
	B - 7/8	B - 7/8	B - 7/8	B - 1 1/8	B - 1 1/8	B - 1 1/8	B - 1 1/8	B - 1 1/8	B - 1 1/8	B - 1 1/8	B - 1 3/8	B - 1 3/8
30	A - 1/2	A - 1/2	A - 1/2	A - 3/4	A - 3/4	A - 3/4	A - 3/4	A - 3/4	A - 3/4	A - 3/4	A - 3/4	A - 3/4
	B - 7/8	B - 7/8	B - 7/8	B - 1 1/8	B - 1 1/8	B - 1 1/8	B - 1 1/8	B - 1 1/8	B - 1 1/8	B - 1 1/8	B - 1 3/8	B - 1 3/8
35	A - 3/4	A - 3/4	A - 3/4	A - 3/4	A - 3/4	A - 3/4	A - 3/4	A - 3/4	A - 3/4	A - 3/4	A - 3/4	A - 3/4
	B - 1 1/8	B - 1 1/8	B - 1 1/8	B - 1 3/8	B - 1 3/8	B - 1 3/8	B - 1 3/8	B - 1 5/8	B - 1 5/8	B - 1 5/8	B - 1 5/8	B - 1 5/8
40	A - 3/4	A - 3/4	A - 3/4	A - 3/4	A - 3/4	A - 3/4	A - 3/4	A - 3/4	A - 3/4	A - 3/4	A - 3/4	A - 3/4
	B - 1 3/8	B - 1 3/8	B - 1 3/8	B - 1 3/8	B - 1 3/8	B - 1 3/8	B - 1 5/8	B - 1 5/8	B - 1 5/8	B - 1 5/8	B - 1 5/8	B - 1 5/8

Calculating Refrigerant and Oil Charge

To estimate the total amount of refrigerant required to charge the system combine the charges from the below two tables for the size system and line sizes used.

Table 5 – Chiller & Condenser Refrigerant Charge

Circuit Capacity (tons)	Chiller and Condenser Combined Summertime Refrigerant Charge (pounds per circuit)	
	(Lbs. of R410A @ 60°F)	(Lbs. of R454B @ 60°F)
5	7.6	7.1
7.5	11.1	10.3
10	15.3	14.2
15	22.2	20.6
20	30.2	28.1
25	37.2	34.5
30	44.3	41.1
35	51.9	48.2
40	59.4	55.1

Table 6 - Field Piping R-410A Refrigerant Charges

Line Size OD (inches)	Discharge Line (Lbs./100' run)		Liquid Line (Lbs./100' run)	
	R410A	R454B	R410A	R454B
3/8	0.4	0.4	3.7	3.5
1/2	0.7	0.6	6.8	6.4
5/8	1.1	0.9	11	10.3
3/4	1.6	1.3	16.4	15.4
7/8	2.2	1.7	22.8	21.3
1 1/8	3.6	2.8	36.7	34.3
1 3/8	5.6	4.2	57.4	53.6
1 5/8	7.9	6.0	81.2	75.8
2 1/8	13.9	10.5	142.1	132.6
2 5/8	21.4	16.2	219.5	204.9

Oil Charge Determination

The chiller is factory charged with the amount of oil required by the chiller only and not the total system. The amount of oil required is dependent upon the amount of refrigerant added to the system for the field-installed piping. Use the following to determine the amount of oil needed for the system.

$$\text{Pints of Oil} = \text{Pounds of refrigerant in system} / 100$$

Oil level should be checked after the chiller has run for 15 minutes.

Setting Condenser Fan Controls

The remote condenser has a controller that cycles the fans as needed to maintain the proper refrigerant pressure. The settings change based on the number of fans in the remote condenser. Refer to Table 7 for the proper pressure settings.

Table 7 - Condenser Fan Pressure Settings (psig)

Stage Number	Setting	Number of Fan Stages			
		1	2	3	4
Stage 1	Max Speed	410	410	410	410
	Min Speed	320	320	320	320
Stage 2	Fan On		400	400	370
	Fan Off		340	340	305
Stage 3	Fan On			435	385
	Fan Off			375	325
Stage 4	Fan On				400
	Fan Off				340

To change the settings, open the remote condenser control panel, remove the cover from the pressure control module, and make sure everything is set as shown below.

Figure 8 – Remote Condenser Fan Control Settings

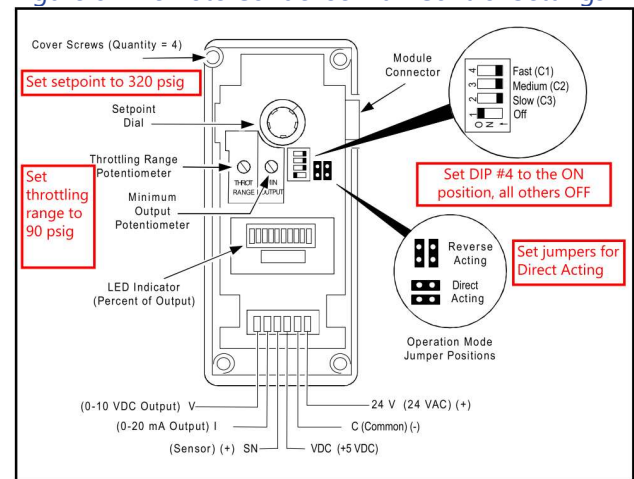

Installation - Electrical

Install all wiring in compliance to all applicable local and national codes. Minimum circuit amps (MCA) and other unit electrical data are on the unit nameplate. An electrical schematic ships with the unit. Measure each leg of the main power supply voltage at the main power source. Voltage must be within the voltage utilization range shown on the drawings included with the unit. If the measured voltage on any leg is not within the specified range, notify the supplier and correct before operating the unit. Voltage imbalance must not exceed 2%. Excessive voltage imbalance between the phases of a three-phase system can cause motors to overheat and eventually fail.

Check the main power phasing with a phase sequence meter prior to applying power. The proper sequence should read "ABC" on the meter. If the meter reads "CBA", open the main power disconnect and switch two line leads on the line power terminal blocks (or the unit mounted disconnect). Do not interchange any load leads that are from the unit contactors or the motor terminals. Operation of the compressor with incorrect electrical phase sequencing will result in mechanical damage to the compressors.



WARNING: This equipment contains hazardous voltages that can cause severe injury or death.



WARNING: This equipment contains refrigerant under pressure. Accidental release of refrigerant under pressure can cause personal injury and or property damage.



WARNING: This equipment may contain fan blades or other sharp edges. Make sure all fan guards and other protective shields are securely in place.



WARNING: The exposed surfaces of motors, refrigerant piping, and other fluid circuit components can be very hot and can cause burns if touched with unprotected hands.



CAUTION: Disconnect and lock out incoming power before installing, servicing, or maintaining the equipment. Connecting power to the main terminal block energizes the entire electric circuitry of the unit. Electric power at the main disconnect should be shut off before opening access panels for repair or maintenance.



CAUTION: Wear eye protection when installing, maintaining, or repairing the equipment to protect against any sparks, debris, or fluid leaks.



CAUTION: Wear protective gloves when installing, maintaining, or repairing the equipment to protect against any sparks, debris, or fluid leaks.



CAUTION: Wire the unit ground in compliance with local and national codes.



CAUTION: The unit requires the main power to remain connected during off-hours to energize the compressor's crankcase heater. Disconnect main power only when servicing the chiller. The crankcase heater should remain on when the compressor is off to ensure liquid refrigerant does not accumulate in the compressor crankcase. Connect main power at least 24 hours prior to initial startup.

Control Operation

The unit uses a Programmable Logic Controller (PLC) and color touch-screen operator interface display that serves as the Human to Machine Interface (HMI).

Screen Navigation

The overall menus structure allows for quick access and navigation to each section of the control monitoring and control system. The following are the main buttons used to navigate through the various screens.



Menu Button – This button is located on the top left of the screen. Touch this button to go to Menu 1.



Home Button – This button is located on the bottom of the screen. Touch this button to go to the Home Overview Screen.



Alarm Button – This button is located on the bottom of the screen. This button shows the number of alarms active. Touch this button to go to the HMI Alarm Handler Screen.



Alarm Reset Button – This button is located on the bottom of the screen. Touch this button to acknowledge and silence active alarms.



Start/Stop Button – This button is located at the bottom right of the screen. Touch this button to start and stop the chiller. When stopped, the button outline is red, when running the button outline is green.



Arrow Button – These buttons appear in multiple areas of the screen. Touch these buttons to navigate forward, back, up or down in menus and screens.

Some screens are password protected to prevent unintended changes. There are two levels of security (*Username is case sensitive*):

“User” Level Password = 9999
“Supervisor” Level Password = 7720

When navigating screens any user adjustable areas appear in a slightly different color. Touching one of these areas brings up a keypad. Use the keypad to enter the appropriate user and password to gain access.

The user-level password allows access to the most common functions; however, there are a few screens protected with a Supervisor-level password. Changing items in Supervisor-level menus without fully understanding the impact can lead to improper or poor performance of the unit. Contact our Customer Service department for assistance with any questions before making changes.

There is a reset function to restore the factory default settings. When this is done you will need to follow the on-screen prompts to reconfigure the chiller based on the options present. For assistance with this process, please contact our Customer Service Department and have the unit Serial Number ready for reference.

System Initialization

When power is initially applied, the first screen to appear is the Start-Up Screen. This screen displays while the PLC and HMI establish communications. The PLC and HMI version shows on the screen and must match.

Figure 9 - Start-Up Screen

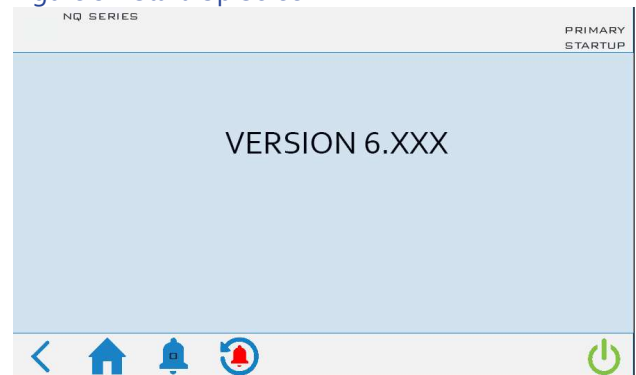

Once control communication is established, the HMI screen automatically switches to the Home Screen.

Home Screen

This screen provides an overall synopsis of the system, quick links to other views, as well as other additional information.

Figure 10 - Home Overview Screen

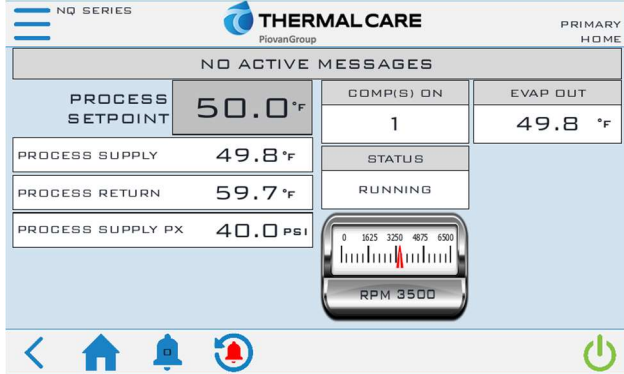

Note: This is an example of a chiller with the most extensive set of options; your screen may appear slightly differently based on your actual chiller configuration.

Use the main screen to navigate to other screens and menus. The menu and screen buttons are located at the bottom of all screens. Touch any one of these to navigate to that menu or screen.

Menu 1 - Overview

The Menu 1 Screen contains buttons to allow navigation to various sections of the control system. Some parameters are password protected. The main User level password is for gaining access to changing the main system set point and various other warning and alarm settings. A few higher-level areas require a high-level "Supervisor" password. Contact our Customer Service Department for assistance in accessing any restricted menus.

Figure 11 - Overview Screen 1

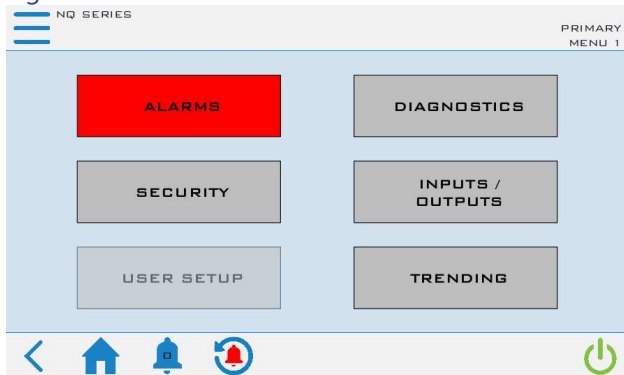
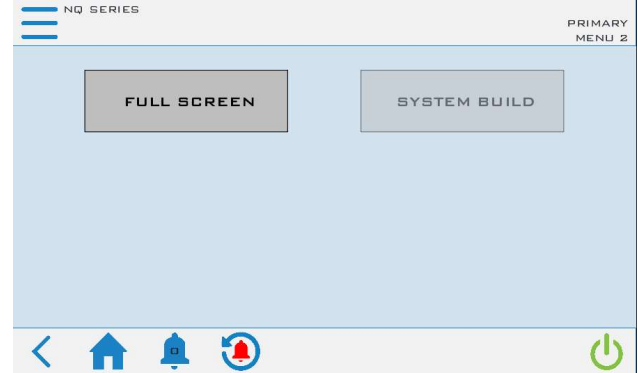

Figure 12 - Overview Screen 2



To return to the Home screen simply touch the Home button. Some screens have links to sub-screens or menus but all have a Home button to allow you to return to the Home screen.

Menu 1 - Alarms

When a critical system fault occurs, the controller activates the HMI alarm handler. This forces the alarm screen to appear and will display the current faults. To silence this alarm, press the ALARM SILENCE button. If multiple alarms are active at once, use the DOWN and UP buttons to view all alarms. When no alarms are active, the white portion of the display will be blank. All alarms must be resolved and reset using the RESET ALARM button.

Figure 13 - HMI Alarm Handler Screen

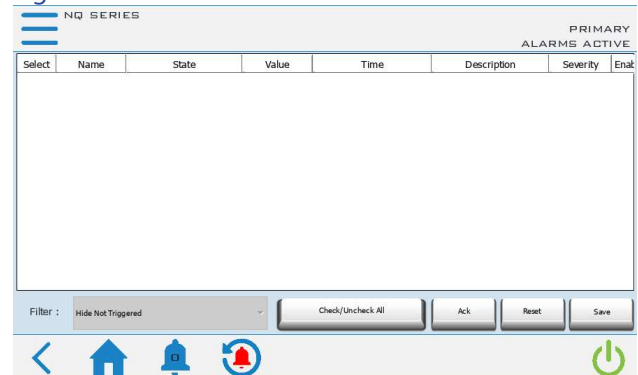

Note: The above shows there are no alarms; if an alarm condition was present, it would appear in this window.

Menu 1 – Diagnostics

The diagnostics screens provide detailed information about the various portions of the system.

Figure 14 - Main Diagnostics Screen

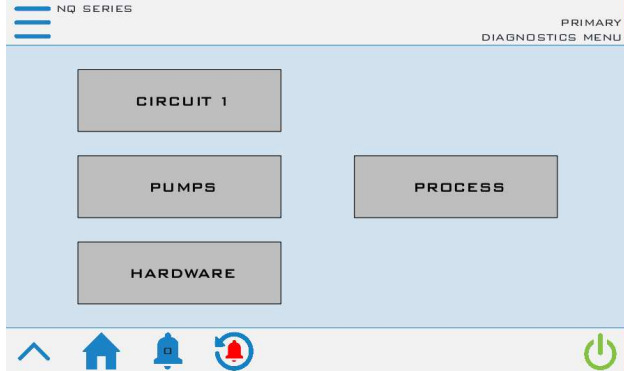

Figure 15 - Diagnostics Screen 1 - Circuit 1 Overview

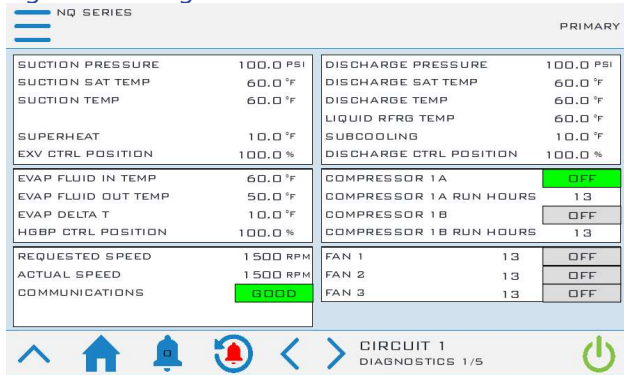

Figure 16 - Diagnostics Screen 2 – Circuit 1 Interlocks

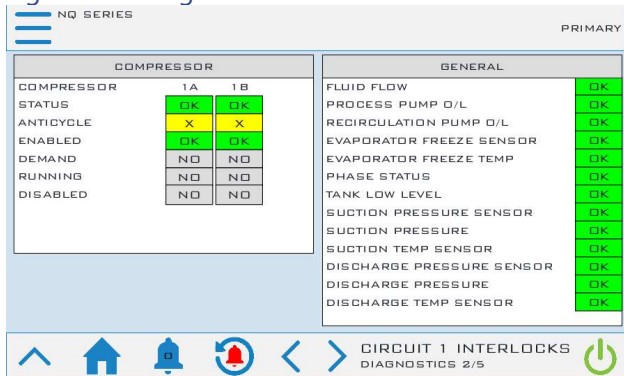

Figure 17 - Diagnostics Screen 3 - Pumps

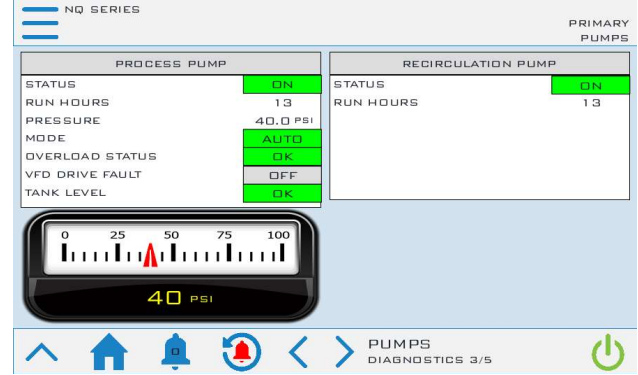

Figure 18 - Diagnostics Screen 4 - Process

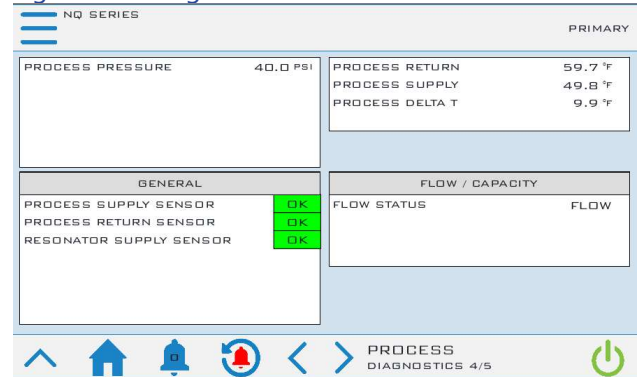
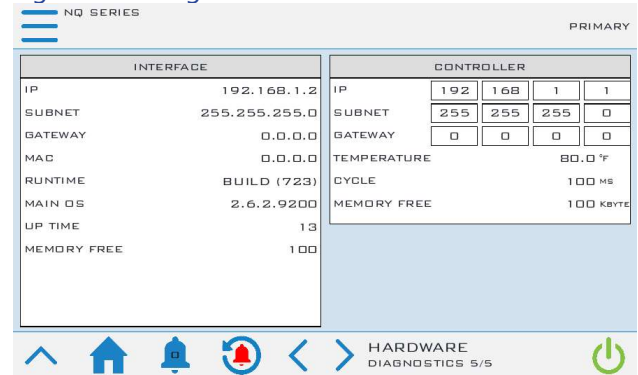

Figure 19 - Diagnostics Screen 5 - Hardware



Menu 1 – Security

To add protection to sensitive areas of the control program and provide some level of supervisory control to some operating parameters, the control system includes some security level protections.

Figure 20 - Main Security Screen

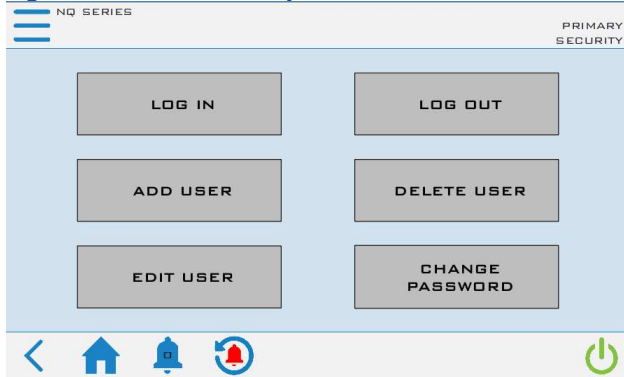

Figure 21 - Security – Log In Screen



Figure 22 - Security – Add User Screen

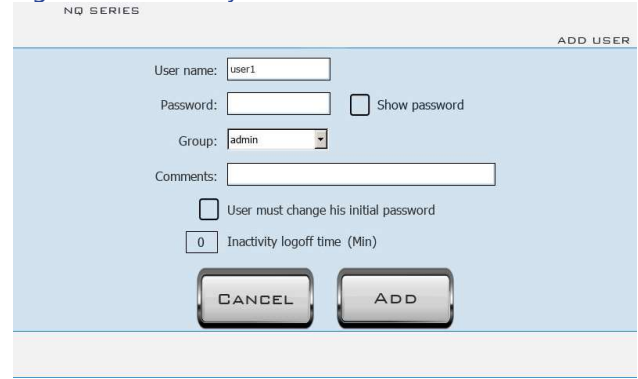

Figure 23 - Security - Edit User Screen

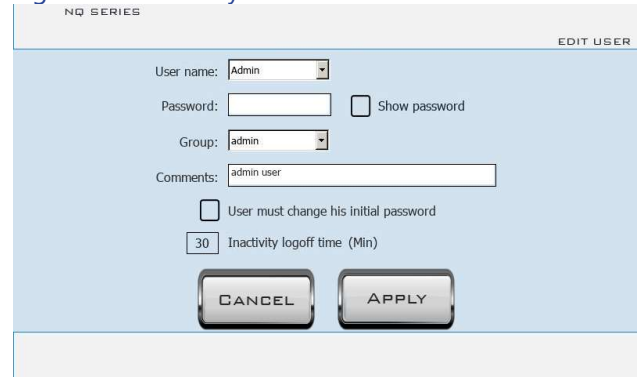

Figure 24 - Security - Delete User Screen

Figure 25 - Security - Change Password Screen

Menu 1 – Input/Output

The Input/Output screens display the status of the various system inputs and outputs. This provides a detailed level of information for monitoring system operation and for diagnosing any performance issues or alarms that arise.

Figure 26 - Main Inputs/Outputs Screen

Figure 27 - Inputs/Outputs – Temperature Inputs Screen

PROCESS RETURN	60.0 °F
PROCESS SUPPLY	50.0 °F
EVAPORATOR LEAVING	50.0 °F
RFRG DISCHARGE	250.0 °F
RFRG SUCTION	170.0 °F
RFRG LIQUID	170.0 °F

Figure 28 - Inputs/Outputs – Pressure Inputs

PROCESS PUMP	50.0 PSI
RFRG SUCTION	150.0 PSI
RFRG DISCHARGE	45.0 PSI

Figure 29 - Inputs/Outputs – Analog Inputs Screen

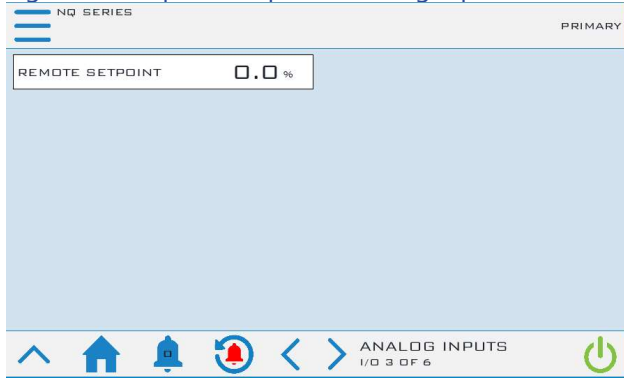

Figure 30 - Inputs/Outputs – Digital Inputs Screen

The screenshot shows the 'DIGITAL INPUTS' screen for the NQ SERIES. It features a table with two columns of inputs, each with a status indicator (OFF). The bottom navigation bar includes icons for home, alarm, and navigation, along with the text 'DIGITAL INPUTS 1/0 4 OF 6' and a power button icon.

REMOTE START	OFF	PROCESS PUMP O/L	OFF
TANK LOW LEVEL OK	OFF	RECIRCULATION PUMP O/L	OFF
TANK HIGH LEVEL OK	OFF	FAN 1 O/L	OFF
EVAP FLOW	OFF	FAN 2 O/L	OFF
PHASE MONITOR	OFF	FAN 3 O/L	OFF
HIGH RFRG PX SWITCH	OFF	UNUSED	OFF
TANK MID LEVEL	OFF	UNUSED	OFF
COMPRESSOR 1A OK	OFF	UNUSED	OFF
COMPRESSOR 1B OK	OFF	IPR	OFF

Figure 31 - Inputs/Outputs – Analog Outputs Screen

The screenshot shows the 'ANALOG OUTPUTS' screen for the NQ SERIES. It lists several output parameters, each with a status indicator (0.0 %). The bottom navigation bar includes icons for home, alarm, and navigation, along with the text 'ANALOG OUTPUTS 1/0 5 OF 6' and a power button icon.

HOT GAS BYPASS	0.0 %
ELECTRONIC EXPANSION VALVE	0.0 %
PROCESS SUPPLY RE-TRANSMIT	0.0 %
DISCHARGE CONTROL	0.0 %
DISCHARGE CONTROL (HPC)	0.0 %
PUMP VFD CONTROL	0.0 %
3-WAY MODULATING VALVE	0.0 %

Figure 32 - Inputs/Outputs – Digital Outputs Screen

The screenshot shows the 'DIGITAL OUTPUTS' screen for the NQ SERIES. It features a table with two columns of outputs, each with a status indicator (OFF). The 'THERMALCARE' logo is visible at the top. The bottom navigation bar includes icons for home, alarm, and navigation, along with the text 'DIGITAL OUTPUTS 1/0 6 OF 6' and a power button icon.

COMPRESSOR 1A	OFF	CONDENSER FAN 2	OFF
COMPRESSOR 1B	OFF	CONDENSER FAN 3	OFF
PROCESS PUMP	OFF	EV2 COOLING	OFF
RECIRCULATION PUMP	OFF	EV2 HPS CONTACT	OFF
ALARM HORN	OFF		
WATER MAKEUP VALVE	OFF		
LIQUID LINE SOLENOID	OFF		
AUX ALARM	OFF		
CONDENSER FAN 1	OFF		

Menu 1 – User Setup

The control system allows for customization and adjustment of many parameters. In most cases, the factory default settings are sufficient; however, adjustment of parameters and settings is possible through the User Setup menus.

Figure 33 - User Setup Menu - Screen 1

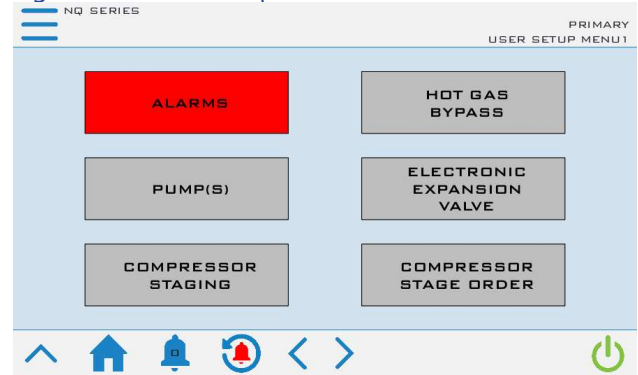

Figure 34 - User Setup Menu - Screen 2

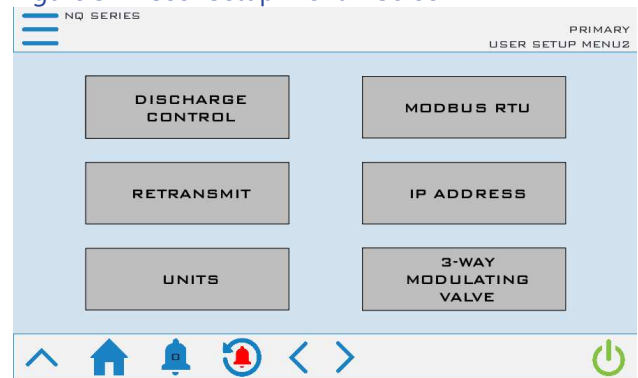

Figure 35 - User Setup Menu - Screen 3

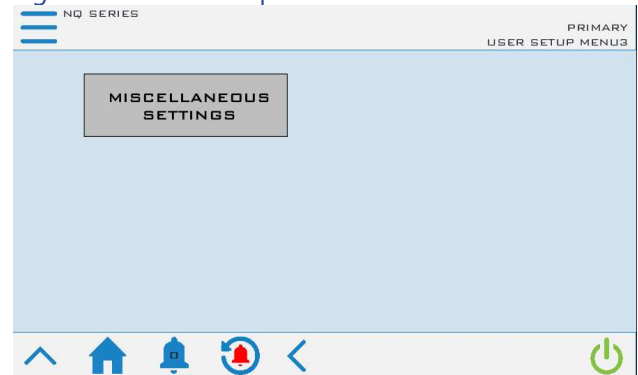

Figure 36 - User Setup – Alarm Setup Screen

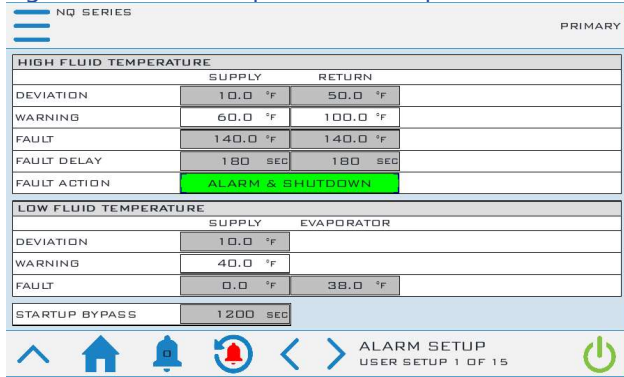

Figure 40 - User Setup – EEV Control Screen

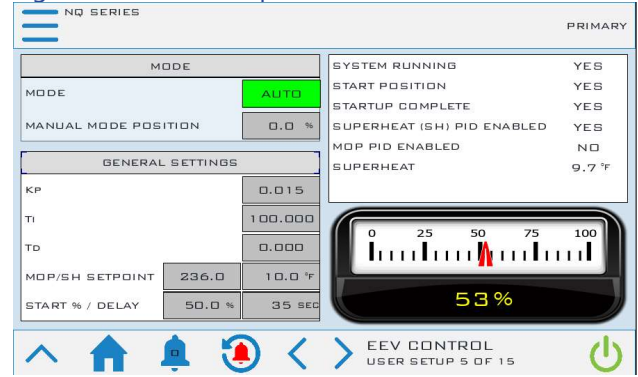

Figure 37 - User Setup – Hot Gas Bypass Screen

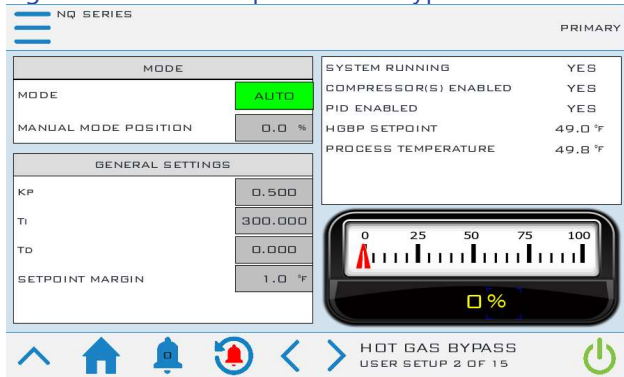

Figure 41 - User Setup – Staging Screen

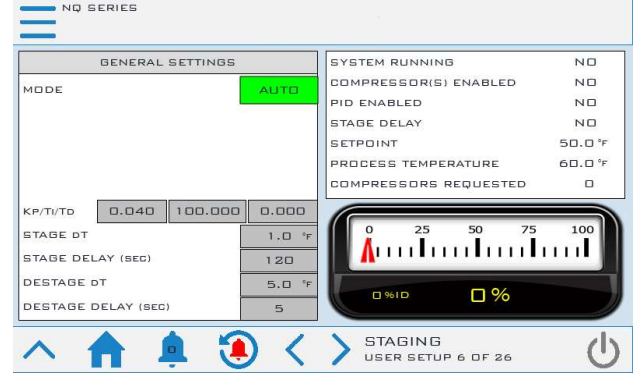

Figure 38 - User Setup – Pumps Screen

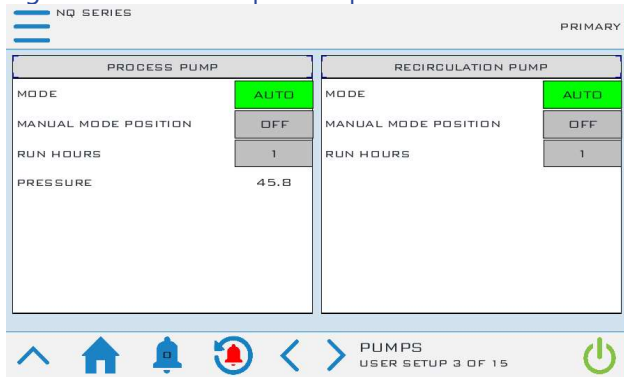

Figure 42 - User Setup – Stage Order Screen

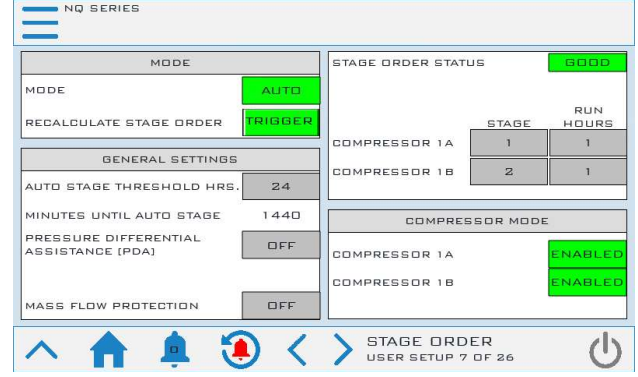

Figure 39 - User Setup – Process Pump VFD Screen

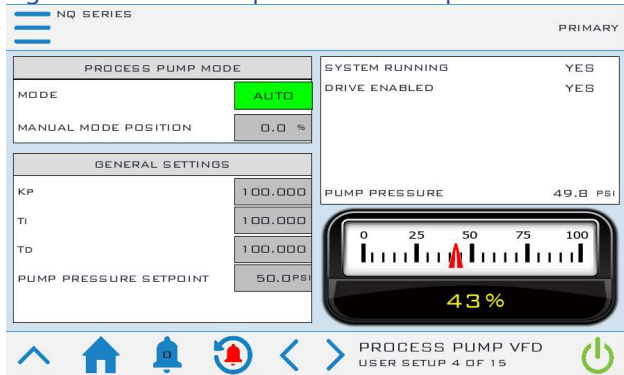

Figure 43 - User Setup – Discharge Control Screen 1

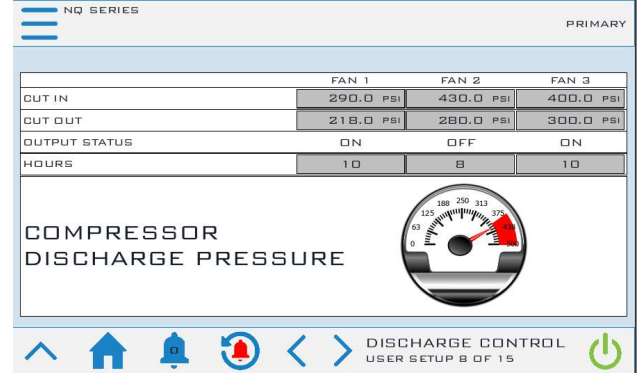

Figure 44 - User Setup – Discharge Control Screen 2

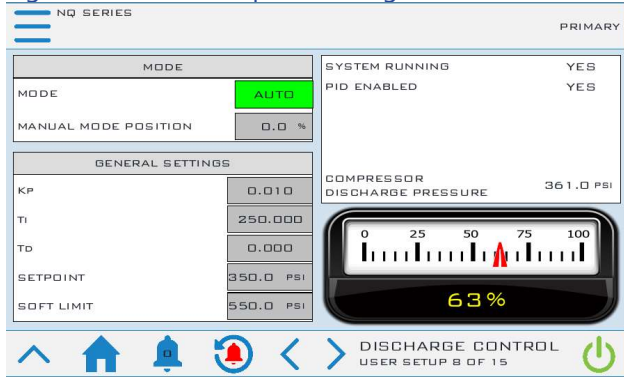

Figure 48 - User Setup – IP Address Screen

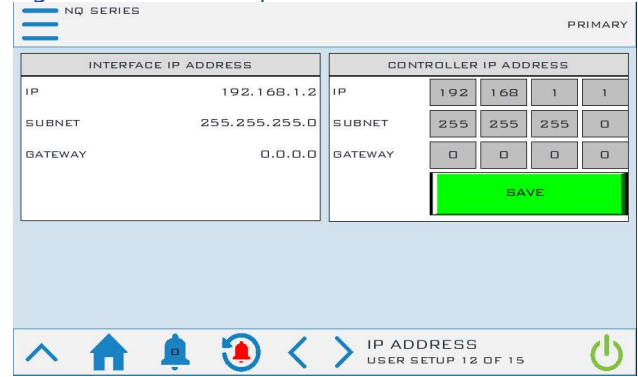

Figure 45 - User Setup – Modbus RTU Screen

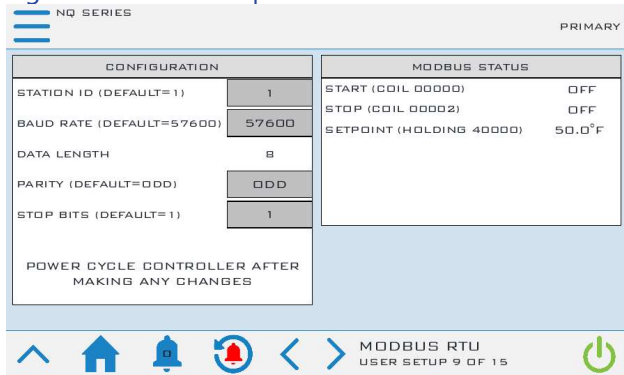

Figure 49 - User Setup – Units Screen

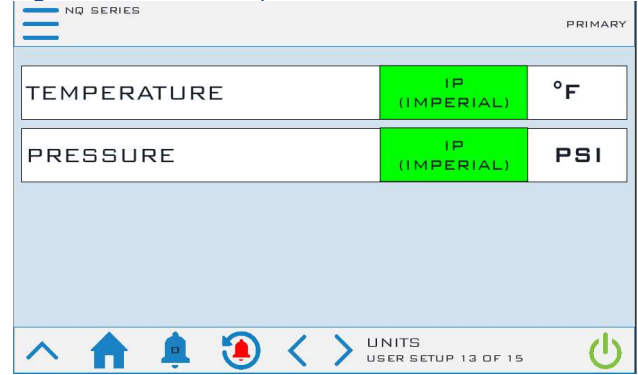

Figure 46 - User Setup – Process Temperature Retransmit Screen

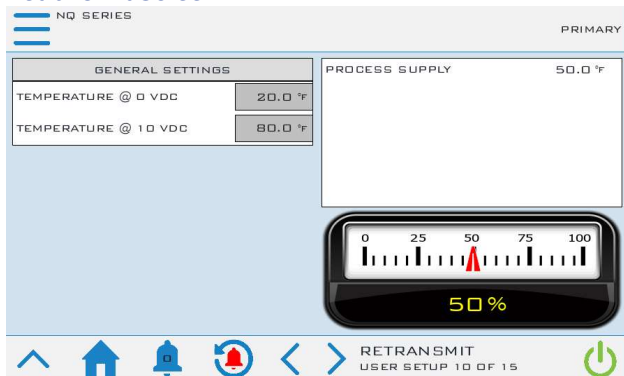

Figure 50 - User Setup – 3-Way Mod Valve Screen

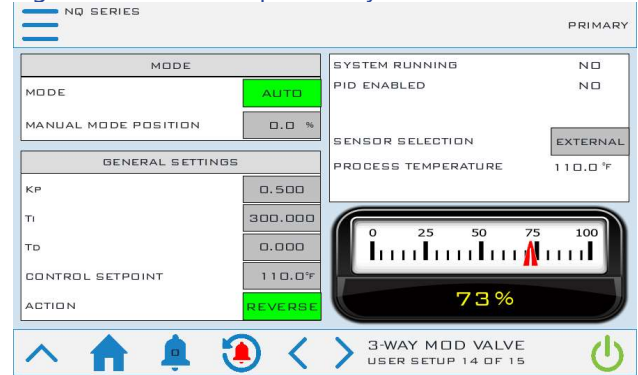

Figure 47 - User Setup – Variable Speed Compressor Screen

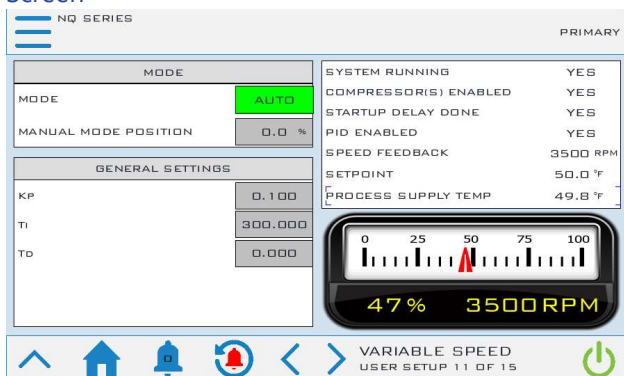

Figure 51 - User Setup – Misc Menu Screen



Figure 52 - User Setup – Evaporator Valve Control Screen

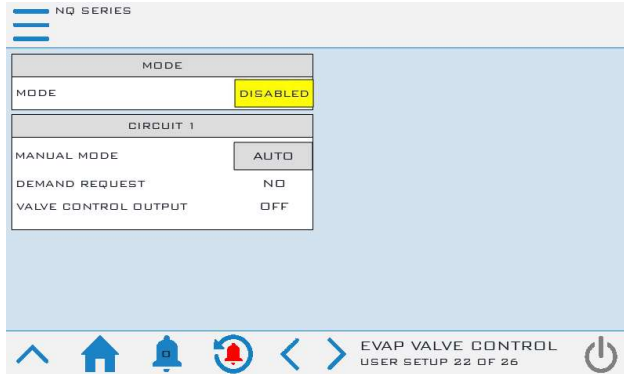

Figure 53 - User Setup – Chiller Tank Screen

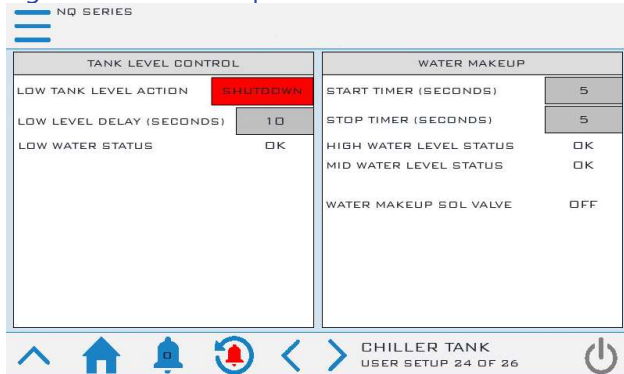

Figure 54 - User Setup – Short Cycle Enabled Screen



Figure 55 - User Setup – Short Cycle Disabled Screen



Menu 1 – Trending

A graphical representation of the core operating parameters of the system is in the trending screen. The trending screen displays the setpoint temperature, evaporator fluid out, process supply and return temperature, and optional hot gas bypass valve resisters (if present) for easy analysis of the system operation. Trending is always enabled and always running.

Figure 56 - System Trending Screen

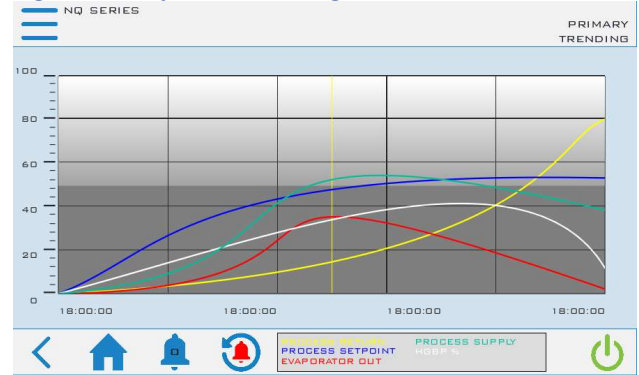

Menu 2 – Full Screen

This screen provides a simple, large-font display of the process supply temperature for users who are primarily concerned only with this data point of the system operation.

Figure 57 - Menu 2 – Full Screen

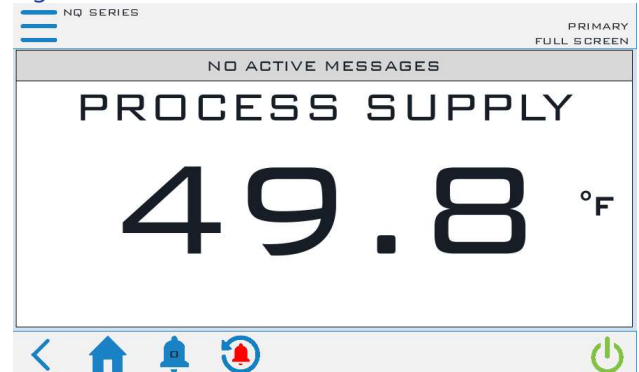

Menu 2 – System Build

This menu allows configuration of the system. Use this menu only with the assistance of someone from the Customer Service Department.



CAUTION: The system configuration screen provides the ability to restore the control system back to factory defaults in the case that an unknown setting modification occurred and the system now behaves unexpectedly. This **will shut down** all operation of the chiller.

Touching SYSTEM BUILD on MENU 2 provides the ability to either review the existing factory build or restore the configuration back to a known factory state. Touch "YES" to enter the system configuration screen. **WARNING: This will shut down all operation of the chiller.**

Figure 58 - Review System Build Screen

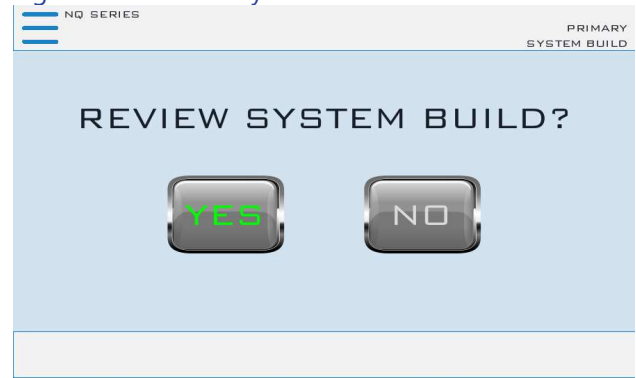

Communications

All standard control systems have Modbus RTU. The Premium control option includes Modbus RTU and TCP/IP and is available with options for BACnet, LonWorks, or OPC/UA communications. The Modbus RTU default set up uses a Baud Rate: 57,600, Data Length: 8 bits, Parity: Odd, Stop Bit: 1 and Station ID: 1. The default IP address of Modbus TCP/IP is 192.168.1.1. This address is adjustable in the User Setup screens.

Table 8 – Modbus Table

Types	Index	Size	Variable Name	Data Type
Coil	0	1	HMI_START	Bool
Coil	1	1	SYSTEM_RUNNING	Bool
Coil	2	1	HMI_STOP	Bool
Coil	3	1	SYSTEM_STOPPING	Bool
Coil	4	1	COMPRESSORS_RUNNING	Bool
Coil	10	1	PHASE_OK	Bool
Coil	11	1	EVAP_FLOW_SWITCH_OK	Bool
Coil	12	1	LPS_OK	Bool
Coil	13	1	LLPS_OK	Bool
Coil	14	1	RFRG_HIGH_PRESSURE_OK	Bool
Coil	15	1	COND_FAN1_EXISTS	Bool
Coil	16	1	COND_FAN1_OVLD_OK	Bool
Coil	17	1	ENABLE_FAN_FS1	Bool
Coil	18	1	COND_FAN2_EXISTS	Bool
Coil	19	1	COND_FAN2_OVLD_OK	Bool
Coil	20	1	ENABLE_FAN_FS2	Bool
Coil	21	1	COND_FAN3_EXISTS	Bool
Coil	22	1	COND_FAN3_OVLD_OK	Bool
Coil	23	1	ENABLE_FAN_FS3	Bool
Coil	25	1	PULSE_2SEC	Bool
Coil	26	1	SYSTEM_NOT_RUNNING	Bool
Coil	30	1	COMP1_EXISTS	Bool
Coil	31	1	COMP1_OVLD_INTERNAL	Bool
Coil	32	1	COMPRESSOR_1_DISABLED	Bool
Coil	33	1	COMP1_REQUEST	Bool
Coil	34	1	COMP1_STATUS_OK	Bool
Coil	35	1	COMP1_OK	Bool
Coil	36	1	COMP1_ANTICYCLE_TIMER_DONE	Bool
Coil	37	1	COMP1_ENABLE	Bool
Coil	40	1	COMP2_EXISTS	Bool
Coil	41	1	COMP2_OVLD_INTERNAL	Bool
Coil	42	1	COMPRESSOR_2_DISABLED	Bool
Coil	43	1	COMP2_REQUEST	Bool
Coil	44	1	COMP2_STATUS_OK	Bool
Coil	45	1	COMP2_OK	Bool
Coil	46	1	COMP2_ANTICYCLE_TIMER_DONE	Bool
Coil	47	1	COMP2_ENABLE	Bool
Coil	56	1	AL_ALARMS_PRESENT	Bool
Coil	57	1	AL_GENERAL_ALARMS	Bool
Coil	58	1	AL_RFRG_ALARM	Bool
Coil	59	1	AL_CRITICAL_ALARM	Bool
Coil	60	1	AL_PHASE_LOSS.Active	Bool
Coil	61	1	AL_PROCESS_PUMP_OVLD.Active	Bool
Coil	62	1	AL_RECIRC_PUMP_OVLD.Active	Bool
Coil	63	1	AL_TANK_LOW_LEVEL.Active	Bool
Coil	64	1	AL_FREEZESTAT.Active	Bool
Coil	65	1	AL_EVAP_FLOW.Active	Bool

Table 8 – Modbus Parameters (continued)

Types	Index	Size	Variable Name	Data Type
Coil	66	1	AL_PRB_EVAP_OUT_FLUID.Active	Bool
Coil	67	1	AL_PRB_SUCTION_TEMP.Active	Bool
Coil	68	1	AL_SUCTION_PX_SENSOR.Active	Bool
Coil	69	1	AL_LPS.Active	Bool
Coil	70	1	AL_LLPS.Active	Bool
Coil	75	1	AL_PRB_DISCHARGE_TEMP.Active	Bool
Coil	76	1	AL_DISCHARGE_PX_SENSOR.Active	Bool
Coil	77	1	AL_DISCHARGE_PX_SOFT_FAULT.Active	Bool
Coil	78	1	AL_HPS.Active	Bool
Coil	79	1	AL_COND_FAN1_OVLD.Active	Bool
Coil	80	1	AL_COND_FAN2_OVLD.Active	Bool
Coil	81	1	AL_COND_FAN3_OVLD.Active	Bool
Coil	82	1	AL_FANS_ALL_FAULTED.Active	Bool
Coil	83	1	AL_PRB_MOD_VALVE.Active	Bool
Coil	84	1	AL_COMP1_STATUS_FAULT.Active	Bool
Coil	85	1	AL_COMP2_STATUS_FAULT.Active	Bool
Coil	87	1	AL_PRB_AMBIENT_TEMP.Active	Bool
Coil	88	1	AL_HIGH_HIGH_RETURN_FLUID_TEMP.Active	Bool
Coil	89	1	AL_PRB_PROCESS_RETURN_FLUID.Active	Bool
Coil	90	1	AL_HIGH_HIGH_SUPPLY_FLUID_TEMP.Active	Bool
Coil	91	1	AL_LOW_LOW_SUPPLY_FLUID_TEMP.Active	Bool
Coil	92	1	AL_PRB_PROCESS_SUPPLY_FLUID.Active	Bool
Coil	93	1	AL_NQV_MODBUS_FAULT.Active	Bool
Coil	94	1	AL_PRB_LIQUID_TEMP.Active	Bool
Coil	95	1	AL_FLOW_SENSOR.Active	Bool
Coil	96	1	AL_PRB_PUMP_PX.Active	Bool
Coil	97	1	AL_CPCOE_COM_FAULT.Active	Bool
Coil	110	1	HIGH_SUPPLY_WATER_TEMP_WARNING	Bool
Coil	111	1	LOW_SUPPLY_WATER_TEMP_WARNING	Bool
Coil	112	1	HIGH_RETURN_WATER_TEMP_WARNING	Bool
Coil	130	1	HGBP_MODE_MANUAL	Bool
Coil	131	1	HGBP_PID_ENABLE	Bool
Coil	140	1	EXV_MODE_MANUAL	Bool
Coil	141	1	EXV_TO_STARTUP_POSITION	Bool
Coil	142	1	EXV_STARTUP_COMPLETE	Bool
Coil	143	1	EXV_SH_ACTIVE	Bool
Coil	144	1	EXV_MOP_ACTIVE	Bool
Coil	150	1	NQV_DRIVE_EV2	Bool
Coil	152	1	NQV_DRIVE_108	Bool
Coil	153	1	NQV_DRIVE_110	Bool
Coil	155	1	NQV_DRV_MANUAL_ENABLE	Bool
Coil	156	1	NQV_DRV_STARTUP_DELAY_DONE	Bool
Coil	157	1	NQV_DRV_PID_ENABLE	Bool
Coil	160	1	PROCESS_PUMP_ON	Bool
Coil	161	1	PROCESS_PUMP_OVLD_OK	Bool
Coil	162	1	PROCESS_PUMP_VFD_CTRL	Bool
Coil	163	1	PUMP_VFD_AUTO	Bool
Coil	164	1	PUMP_VFD_ON	Bool
Coil	170	1	RECIRC_PUMP_ON	Bool
Coil	171	1	RECIRC_PUMP_OVLD_OK	Bool
Coil	180	1	TANK_LOW_WATER_LEVEL_OK	Bool
Coil	181	1	TANK_MID_WATER_LEVEL_OK	Bool
Coil	182	1	TANK_HIGH_WATER_LEVEL_OK	Bool
Coil	183	1	WATER_MAKEUP_ENABLE	Bool
Coil	191	1	MOD_VALVE_MANUAL_MODE	Bool
Coil	192	1	MOD_VALVE_PID_ENA	Bool
Coil	193	1	MOD_VALVE_DIRECT_ACTING	Bool

Table 8 – Modbus Parameters (continued)

Types	Index	Size	Variable Name	Data Type
Coil	201	1	COMPRESSOR_STAGING_MANUAL	Bool
Coil	203	1	STAGE_ERROR	Bool
Coil	204	1	STAGE1_TRIGGER_ON	Bool
Coil	205	1	STAGE1_TRIGGER_OFF	Bool
Coil	206	1	STAGE2_TRIGGER_ON	Bool
Coil	207	1	STAGE2_TRIGGER_OFF	Bool
Coil	220	1	SECONDARY_MODE	Bool
Coil	221	1	PRIMARY_SECONDARY_ENA	Bool
Coil	243	1	PROCESS_PUMP_MANUAL_MODE	Bool
Coil	244	1	PROCESS_PUMP_MANUAL_MODE_ON	Bool
Coil	491	1	AUTO_START_ENABLED	Bool
Coil	498	1	REMOTE_START	Bool
Coil	500	1	MONITOR_HIGH_LOW_TEMPS	Bool
Coil	502	1	DISCHARGE_AUTO_MODE	Bool
Coil	503	1	DISCHARGE_PID_ENABLE	Bool
Coil	511	1	LOW_AMBIENT	Bool
Coil	512	1	PROCESS_RETURN_CONTROL	Bool
Coil	524	1	DISCRETE_HPS_OK	Bool
Coil	549	1	RECIRC_PUMP_DISABLED	Bool
Coil	553	1	NQV_DRV_AUTO_MODE	Bool
Coil	555	1	MOD_VALVE_RETURN_SENSOR_SELECTED	Bool
Coil	558	1	AL_NO_ALARMS	Bool
HoldingRegister	1	2	CHILLER_SETPOINT	Real
HoldingRegister	47	2	SUPPLY_WATER_LOW_LOW_TEMP_ALARM	Real
HoldingRegister	50	2	HIGH_PROCESS_RETURN_WATER_dT	Real
HoldingRegister	52	2	RETURN_WATER_HIGH_HIGH_TEMP_ALARM	Real
HoldingRegister	54	1	RETURN_WATER_HIGH_HIGH_TEMP_DELAY	Int
HoldingRegister	55	2	RETURN_WATER_HIGH_WARNING_HMI	Real
HoldingRegister	60	1	WTR_TEMP_BYPASS_TIME_SECONDS	Int
HoldingRegister	61	1	NO_FLOW_TIME_DELAY_SEC	Int
HoldingRegister	62	2	FREEZESTAT_SETPOINT	Real
HoldingRegister	64	2	SUCTION_PRESSURE_BYPASS_TIMER	DInt
HoldingRegister	70	1	CONDENSER_FAN_COUNT	Int
HoldingRegister	71	1	FAN1_CUTIN_PSIG	Int
HoldingRegister	72	1	FAN1_CUTOUT_PSIG	Int
HoldingRegister	73	2	FAN1_HOURS_RETAIN	UDInt
HoldingRegister	75	1	FAN2_CUTIN_PSIG	Int
HoldingRegister	76	1	FAN2_CUTOUT_PSIG	Int
HoldingRegister	77	2	FAN2_HOURS_RETAIN	UDInt
HoldingRegister	79	1	FAN3_CUTIN_PSIG	Int
HoldingRegister	80	1	FAN3_CUTOUT_PSIG	Int
HoldingRegister	81	2	FAN3_HOURS_RETAIN	UDInt
HoldingRegister	84	2	DISCHARGE_MANUAL_PERCENT	Real
HoldingRegister	92	2	DISCHARGE_PX_SETPOINT_FIXED_HMI	Real
HoldingRegister	100	2	HGBP_MANUAL_PERCENT	Real
HoldingRegister	102	2	HGBP_SETPOINT_MARGIN_HMI	Real
HoldingRegister	120	2	EXV_MANUAL_PERCENT	Real
HoldingRegister	128	2	SUPERHEAT_SETPOINT	Real
HoldingRegister	130	2	EXV_START_PERCENT	Real
HoldingRegister	132	1	EXV_START_DELAY	Int
HoldingRegister	133	2	MOP_SETPOINT	Real
HoldingRegister	140	1	NQV_DRV_MANUAL_PERCENT	Int
HoldingRegister	155	2	PROCESS_PUMP_MANUAL_PERCENT	Real
HoldingRegister	163	2	PROCESS_PUMP_SETPOINT_HMI	Real
HoldingRegister	165	2	PROCESS_PUMP_HOURS_RETAIN	UDInt
HoldingRegister	167	2	RECIRC_PUMP_HOURS_RETAIN	UDInt

Table 8 – Modbus Parameters (continued)

Types	Index	Size	Variable Name	Data Type
HoldingRegister	170	2	MOD_VALVE_MANUAL_PERCENT	Real
HoldingRegister	172	2	MOD_VALVE_SETPOINT	Real
HoldingRegister	201	1	COMPRESSOR_STAGE_ORDER_C1	Int
HoldingRegister	202	1	COMPRESSOR_STAGE_ORDER_C2	Int
HoldingRegister	205	2	COMP1_HOURS_RETAIN	UDInt
HoldingRegister	207	2	COMP2_HOURS_RETAIN	UDInt
InputRegister	1	2	PLC_VERSION	Real
InputRegister	6	2	CAREL_TEMP_HMI	Real
InputRegister	12	1	AUTOSTART_REMAINING	Int
InputRegister	20	2	ANALOG_IN.RFRG_SUCTION_TEMP_HMI	Real
InputRegister	22	2	SUCTION_PRESSURE_HMI	Real
InputRegister	24	1	SUCTION_PX_BYPASS_TIME_REMAINING	Int
InputRegister	25	2	SUCTION_SATURATED_TEMP_HMI	Real
InputRegister	27	2	SUPERHEAT_HMI	Real
InputRegister	30	2	ANALOG_IN.RFRG_DISCHARGE_TEMP_HMI	Real
InputRegister	32	2	DISCHARGE_PRESSURE_HMI	Real
InputRegister	34	2	DISCHARGE_SATURATED_TEMP_HMI	Real
InputRegister	36	2	SUBCOOLING_HMI	Real
InputRegister	38	2	LIQUID_TEMP_HMI	Real
InputRegister	40	2	PROCESS_SUPPLY_FLUID	Real
InputRegister	42	2	PROCESS_RETURN_FLUID	Real
InputRegister	44	2	PROCESS_DELTA_T_HMI	Real
InputRegister	46	2	PROCESS_VARIABLE_HMI	Real
InputRegister	50	2	EVAP_OUT_FLUID	Real
InputRegister	52	2	EVAP_DELTA_T_HMI	Real
InputRegister	70	1	HMI_ALARM_DISPLAY	Int
InputRegister	71	1	SUPPLY_WATER_BYPASS_REMIANING	Int
InputRegister	72	2	SUPPLY_WATER_HIGH_WARNING_HMI	Real
InputRegister	74	1	SUPPLY_WATER_HIGH_HIGH_FAULT_TIME	Int
InputRegister	75	2	SUPPLY_WATER_LOW_WARNING_HMI	Real
InputRegister	80	1	RETURN_WATER_HIGH_HIGH_FAULT_TIME	Int
InputRegister	90	2	DISCHARGE_PERCENT	Real
InputRegister	100	2	HGBP_PERCENT	Real
InputRegister	102	2	HGBP_SETPOINT_HMI	Real
InputRegister	110	2	EXV_PERCENT	Real
InputRegister	120	1	NQV_DRV_SPEED_FEEDBACK_INT	Int
InputRegister	122	1	NQV_DRV_PID_RPM	Int
InputRegister	123	1	NQV_DRV_DEMAND_PERCENT	Int
InputRegister	124	1	NQV_DRV_BUS_VOLTAGE	Int
InputRegister	125	1	NQV_DRV_AC_INPUT_VOLTAGE	Int
InputRegister	126	1	NQV_DRV_AC_INPUT_CURRENT	Int
InputRegister	127	1	NQV_DRV_AC_INPUT_POWER	Int
InputRegister	128	1	NQV_DRV_COMP_PHASE_CURRENT	Int
InputRegister	131	1	NQV_STATOR_HEATING_WATTAGE	Int
InputRegister	132	2	NQV_CSD100_SOFTWARE_VERSION	Real
InputRegister	134	1	NQV_SPEED_REF_AFTER_ENVELOPE_CONTROL	Int
InputRegister	135	1	NQV_SOFTWARE_SYSTEM_STATE	Int
InputRegister	136	2	NQV_MODBUS_READ_COUNTER	UDInt
InputRegister	138	1	NQV_FIELD_BUS_COMMS_MONITOR	Int
InputRegister	139	1	NQV_TRIP_LOCKOUT_NUMBER	Int
InputRegister	140	1	NQV_SYSTEM_CONTROL_WORD	Int
InputRegister	141	1	NQV_EV2_03_MAX_FREQUENCY	Int
InputRegister	142	1	NQV_EV2_04_MIN_FREQUENCY	Int
InputRegister	143	1	NQV_EV2_05_STATUS	Int
InputRegister	144	1	NQV_EV2_48_COMP_PHASE_CURRENT_FOLDBACK_STATUS	Int
InputRegister	145	1	NQV_EV2_49_PWR_MOD_TEMP_FOLDBACK_STATUS	Int

Table 8 – Modbus Parameters (continued)

Types	Index	Size	Variable Name	Data Type
InputRegister	146	1	NQV_EV2_50_AC_INPUT_CURRENT_FOLDBACK_STATUS	Int
InputRegister	147	1	NQV_EV2_59_POWERUP_STATUS	Int
InputRegister	148	2	NQV_EV2_POWER_MODULE_TEMP	Real
InputRegister	150	2	NQV_EV2_DLT	Real
InputRegister	152	1	NQV_EV2_78_1ST_FAULT_OCCURRED	Int
InputRegister	153	1	NQV_EV2_79_1ST_FAULT_OCCURRED	Int
InputRegister	154	1	COMP1_ANTI_CYCLE_TIME	Int
InputRegister	155	1	COMP2_ANTI_CYCLE_TIME	Int
InputRegister	160	2	PUMP_PRESSURE_HMI	Real
InputRegister	162	2	PROCESS_PUMP_PID_PERCENT	Real
InputRegister	180	2	MOD_VALVE_CTRL_TEMP_HMI	Real
InputRegister	182	2	MOD_VALVE_PERCENT	Real
InputRegister	190	2	STAGE1_CUT_IN_TEMP_HMI	Real
InputRegister	192	2	STAGE1_CUT_OUT_TEMP_HMI	Real
InputRegister	194	2	STAGE2_CUT_IN_TEMP_HMI	Real
InputRegister	196	2	STAGE2_CUT_OUT_TEMP_HMI	Real
InputRegister	202	1	STAGED_COMPRESSORS_RUNNING	Int
InputRegister	203	1	STAGED_COMPRESSORS_REQUESTED	Int
InputRegister	204	1	STAGE_MINUTES_UNTIL_NEXT_STAGE	Int
InputRegister	206	1	RETRANSMIT_PERCENT	Int
InputRegister	226	1	CHILLER_STATUS	UInt
InputRegister	231	2	EVAP_IN_FLUID_HMI	Real

Table 9 – BACNet Parameters

Type	Object Instance	Variable Name	Data Type
BinaryValue	1	HMI_START	Bool
BinaryValue	2	SYSTEM_RUNNING	Bool
BinaryValue	3	HMI_STOP	Bool
BinaryValue	4	SYSTEM_STOPPING	Bool
BinaryValue	5	COMPRESSORS_RUNNING	Bool
BinaryValue	6	PHASE_OK	Bool
BinaryValue	7	EVAP_FLOW_SWITCH_OK	Bool
BinaryValue	8	LPS_OK	Bool
BinaryValue	9	LLPS_OK	Bool
BinaryValue	10	RFRG_HIGH_PRESSURE_OK	Bool
BinaryValue	11	COND_FAN1_EXISTS	Bool
BinaryValue	12	COND_FAN1_OVLD_OK	Bool
BinaryValue	13	ENABLE_FAN_FS1	Bool
BinaryValue	14	COND_FAN2_EXISTS	Bool
BinaryValue	15	COND_FAN2_OVLD_OK	Bool
BinaryValue	16	ENABLE_FAN_FS2	Bool
BinaryValue	17	COND_FAN3_EXISTS	Bool
BinaryValue	18	COND_FAN3_OVLD_OK	Bool
BinaryValue	19	ENABLE_FAN_FS3	Bool
BinaryValue	20	PULSE_2SEC	Bool
BinaryValue	21	SYSTEM_NOT_RUNNING	Bool
BinaryValue	22	COMP1_EXISTS	Bool
BinaryValue	23	COMP1_OVLD_INTERNAL	Bool
BinaryValue	24	COMPRESSOR_1_DISABLED	Bool
BinaryValue	25	COMP1_REQUEST	Bool
BinaryValue	26	COMP1_STATUS_OK	Bool
BinaryValue	27	COMP1_OK	Bool
BinaryValue	28	COMP1_ANTICYCLE_TIMER_DONE	Bool
BinaryValue	29	COMP1_ENABLE	Bool
BinaryValue	30	COMP2_EXISTS	Bool

Table 9 – BACNet Parameters (continued)

Type	Object Instance	Variable Name	Data Type
BinaryValue	31	COMP2_OVLD_INTERNAL	Bool
BinaryValue	32	COMPRESSOR_2_DISABLED	Bool
BinaryValue	33	COMP2_REQUEST	Bool
BinaryValue	34	COMP2_STATUS_OK	Bool
BinaryValue	35	COMP2_OK	Bool
BinaryValue	36	COMP2_ANTICYCLE_TIMER_DONE	Bool
BinaryValue	37	COMP2_ENABLE	Bool
BinaryValue	38	AL_ALARMS_PRESENT	Bool
BinaryValue	39	AL_GENERAL_ALARMS	Bool
BinaryValue	40	AL_RFRG_ALARM	Bool
BinaryValue	41	AL_CRITICAL_ALARM	Bool
BinaryValue	42	AL_PHASE_LOSS.Active	Bool
BinaryValue	43	AL_PROCESS_PUMP_OVLD.Active	Bool
BinaryValue	44	AL_RECIRC_PUMP_OVLD.Active	Bool
BinaryValue	45	AL_TANK_LOW_LEVEL.Active	Bool
BinaryValue	46	AL_FREEZESTAT.Active	Bool
BinaryValue	47	AL_EVAP_FLOW.Active	Bool
BinaryValue	48	AL_PRB_EVAP_OUT_FLUID.Active	Bool
BinaryValue	49	AL_PRB_SUCTION_TEMP.Active	Bool
BinaryValue	50	AL_SUCTION_PX_SENSOR.Active	Bool
BinaryValue	51	AL_LPS.Active	Bool
BinaryValue	52	AL_LLPS.Active	Bool
BinaryValue	53	AL_PRB_DISCHARGE_TEMP.Active	Bool
BinaryValue	54	AL_DISCHARGE_PX_SENSOR.Active	Bool
BinaryValue	55	AL_DISCHARGE_PX_SOFT_FAULT.Active	Bool
BinaryValue	56	AL_HPS.Active	Bool
BinaryValue	57	AL_COND_FAN1_OVLD.Active	Bool
BinaryValue	58	AL_COND_FAN2_OVLD.Active	Bool
BinaryValue	59	AL_COND_FAN3_OVLD.Active	Bool
BinaryValue	60	AL_FANS_ALL_FAULTED.Active	Bool
BinaryValue	61	AL_PRB_MOD_VALVE.Active	Bool
BinaryValue	62	AL_COMP1_STATUS_FAULT.Active	Bool
BinaryValue	63	AL_COMP2_STATUS_FAULT.Active	Bool
BinaryValue	64	AL_PRB_AMBIENT_TEMP.Active	Bool
BinaryValue	65	AL_HIGH_HIGH_RETURN_FLUID_TEMP.Active	Bool
BinaryValue	66	AL_PRB_PROCESS_RETURN_FLUID.Active	Bool
BinaryValue	67	AL_HIGH_HIGH_SUPPLY_FLUID_TEMP.Active	Bool
BinaryValue	68	AL_LOW_LOW_SUPPLY_FLUID_TEMP.Active	Bool
BinaryValue	69	AL_PRB_PROCESS_SUPPLY_FLUID.Active	Bool
BinaryValue	70	AL_NQV_MODBUS_FAULT.Active	Bool
BinaryValue	71	AL_PRB_LIQUID_TEMP.Active	Bool
BinaryValue	72	AL_FLOW_SENSOR.Active	Bool
BinaryValue	73	AL_PRB_PUMP_PX.Active	Bool
BinaryValue	74	AL_CPcoe_COM_FAULT.Active	Bool
BinaryValue	75	HIGH_SUPPLY_WATER_TEMP_WARNING	Bool
BinaryValue	76	LOW_SUPPLY_WATER_TEMP_WARNING	Bool
BinaryValue	77	HIGH_RETURN_WATER_TEMP_WARNING	Bool
BinaryValue	78	HGBP_MODE_MANUAL	Bool
BinaryValue	79	HGBP_PID_ENABLE	Bool
BinaryValue	80	EXV_MODE_MANUAL	Bool
BinaryValue	81	EXV_TO_STARTUP_POSITION	Bool
BinaryValue	82	EXV_STARTUP_COMPLETE	Bool
BinaryValue	83	EXV_SH_ACTIVE	Bool
BinaryValue	84	EXV_MOP_ACTIVE	Bool
BinaryValue	85	NQV_DRIVE_EV2	Bool

Table 9 – BACNet Parameters (continued)

Type	Object Instance	Variable Name	Data Type
BinaryValue	86	NQV_DRIVE_108	Bool
BinaryValue	87	NQV_DRIVE_110	Bool
BinaryValue	88	NQV_DRV_MANUAL_ENABLE	Bool
BinaryValue	89	NQV_DRV_STARTUP_DELAY_DONE	Bool
BinaryValue	90	NQV_DRV_PID_ENABLE	Bool
BinaryValue	91	PROCESS_PUMP_ON	Bool
BinaryValue	92	PROCESS_PUMP_OVLD_OK	Bool
BinaryValue	93	PROCESS_PUMP_VFD_CTRL	Bool
BinaryValue	94	PUMP_VFD_AUTO	Bool
BinaryValue	95	PUMP_VFD_ON	Bool
BinaryValue	96	RECIRC_PUMP_ON	Bool
BinaryValue	97	RECIRC_PUMP_OVLD_OK	Bool
BinaryValue	98	TANK_LOW_WATER_LEVEL_OK	Bool
BinaryValue	99	TANK_MID_WATER_LEVEL_OK	Bool
BinaryValue	100	TANK_HI_WATER_LEVEL_OK	Bool
BinaryValue	101	WATER_MAKEUP_ENABLE	Bool
BinaryValue	102	MOD_VALVE_MANUAL_MODE	Bool
BinaryValue	103	MOD_VALVE_PID_ENA	Bool
BinaryValue	104	MOD_VALVE_DIRECT_ACTING	Bool
BinaryValue	105	COMPRESSOR_STAGING_MANUAL	Bool
BinaryValue	106	STAGE_ERROR	Bool
BinaryValue	107	STAGE1_TRIGGER_ON	Bool
BinaryValue	108	STAGE1_TRIGGER_OFF	Bool
BinaryValue	109	STAGE2_TRIGGER_ON	Bool
BinaryValue	110	STAGE2_TRIGGER_OFF	Bool
BinaryValue	111	SECONDARY_MODE	Bool
BinaryValue	112	PRIMARY_SECONDARY_ENA	Bool
BinaryValue	113	PROCESS_PUMP_MANUAL_MODE	Bool
BinaryValue	114	PROCESS_PUMP_MANUAL_MODE_ON	Bool
BinaryValue	115	AUTO_START_ENABLED	Bool
BinaryValue	116	REMOTE_START	Bool
BinaryValue	117	MONITOR_HI_LO_TEMPS	Bool
BinaryValue	118	DISCHARGE_AUTO_MODE	Bool
BinaryValue	119	DISCHARGE_PID_ENABLE	Bool
BinaryValue	120	LOW_AMBIENT	Bool
BinaryValue	121	PROCESS_RETURN_CONTROL	Bool
BinaryValue	122	DISCRETE_HPS_OK	Bool
BinaryValue	123	RECIRC_PUMP_DISABLED	Bool
BinaryValue	124	NQV_DRV_AUTO_MODE	Bool
BinaryValue	125	MOD_VALVE_RETURN_SENSOR_SELECTED	Bool
BinaryValue	126	AL_NO_ALARMS	Bool
AnalogValue	127	CHILLER_SETPOINT	Real
PositiveIntegerValue	128	MODBUS_RTU_STATION_ID	USInt
PositiveIntegerValue	129	MODBUS_RTU_BAUDRATE_SELECTOR	USInt
PositiveIntegerValue	130	MODBUS_RTU_PARITY	UInt
PositiveIntegerValue	131	MODBUS_RTU_STOP_BITS	USInt
IntegerValue	132	DATA_LOG_SAMPLE_RATE	Int
AnalogValue	133	HIGH_PROCESS_SUPPLY_WATER_dT	Real
AnalogValue	134	SUPPLY_WATER_HIGH_HIGH_TEMP_ALARM	Real
IntegerValue	135	SUPPLY_WATRR_HIGH_HIGH_TEMP_DELAY	Int
AnalogValue	136	LOW_PROCESS_SUPPLY_WATER_dT	Real
AnalogValue	137	SUPPLY_WATER_LOW_LOW_TEMP_ALARM	Real
AnalogValue	138	HIGH_PROCESS_RETURN_WATER_dT	Real
AnalogValue	139	RETURN_WATER_HIGH_HIGH_TEMP_ALARM	Real
IntegerValue	140	RETURN_WATER_HIGH_HIGH_TEMP_DELAY	Int

Table 9 – BACNet Parameters (continued)

Type	Object Instance	Variable Name	Data Type
AnalogValue	141	RETURN_WATER_HIGH_WARNING_HMI	Real
IntegerValue	142	WTR_TEMP_BYPASS_TIME_SECONDS	Int
IntegerValue	143	NO_FLOW_TIME_DELAY_SEC	Int
AnalogValue	144	FREEZESTAT_SETPOINT	Real
IntegerValue	145	SUCTION_PRESSURE_BYPASS_TIMER	DInt
IntegerValue	146	CONDENSER_FAN_COUNT	Int
IntegerValue	147	FAN1_CUTIN_PSIG	Int
IntegerValue	148	FAN1_CUTOUT_PSIG	Int
PositiveIntegerValue	149	FAN1_HOURS_RETAIN	UDInt
IntegerValue	150	FAN2_CUTIN_PSIG	Int
IntegerValue	151	FAN2_CUTOUT_PSIG	Int
PositiveIntegerValue	152	FAN2_HOURS_RETAIN	UDInt
IntegerValue	153	FAN3_CUTIN_PSIG	Int
IntegerValue	154	FAN3_CUTOUT_PSIG	Int
PositiveIntegerValue	155	FAN3_HOURS_RETAIN	UDInt
AnalogValue	156	DISCHARGE_MANUAL_PERCENT	Real
AnalogValue	157	DISCHARGE_PX_SETPOINT_FIXED_HMI	Real
AnalogValue	158	HGBP_MANUAL_PERCENT	Real
AnalogValue	159	HGBP_SETPOINT_MARGIN_HMI	Real
AnalogValue	160	EXV_MANUAL_PERCENT	Real
AnalogValue	161	SUPERHEAT_SETPOINT	Real
AnalogValue	162	EXV_START_PERCENT	Real
IntegerValue	163	EXV_START_DELAY	Int
AnalogValue	164	MOP_SETPOINT	Real
IntegerValue	165	NQV_DRV_MANUAL_PERCENT	Int
AnalogValue	166	PROCESS_PUMP_MANUAL_PERCENT	Real
AnalogValue	167	PROCESS_PUMP_SETPOINT_HMI	Real
PositiveIntegerValue	168	PROCESS_PUMP_HOURS_RETAIN	UDInt
PositiveIntegerValue	169	RECIRC_PUMP_HOURS_RETAIN	UDInt
AnalogValue	170	MOD_VALVE_MANUAL_PERCENT	Real
AnalogValue	171	MOD_VALVE_SETPOINT	Real
IntegerValue	172	COMPRESSOR_STAGE_ORDER_C1	Int
IntegerValue	173	COMPRESSOR_STAGE_ORDER_C2	Int
PositiveIntegerValue	174	COMP1_HOURS_RETAIN	UDInt
PositiveIntegerValue	175	COMP2_HOURS_RETAIN	UDInt
AnalogValue	176	PLC_VERSION	Real
AnalogValue	177	CAREL_TEMP_HMI	Real
IntegerValue	178	AUTOSTART_REMAINING	Int
AnalogValue	179	ANALOG_IN.RFRG_SUCTION_TEMP_HMI	Real
AnalogValue	180	SUCTION_PRESSURE_HMI	Real
IntegerValue	181	SUCTION_PX_BYPASS_TIME_REMAINING	Int
AnalogValue	182	SUCTION_SATURATED_TEMP_HMI	Real
AnalogValue	183	SUPERHEAT_HMI	Real
AnalogValue	184	ANALOG_IN.RFRG_DISCHARGE_TEMP_HMI	Real
AnalogValue	185	DISCHARGE_PRESSURE_HMI	Real
AnalogValue	186	DISCHARGE_SATURATED_TEMP_HMI	Real
AnalogValue	187	SUBCOOLING_HMI	Real
AnalogValue	188	LIQUID_TEMP_HMI	Real
AnalogValue	189	PROCESS_SUPPLY_FLUID	Real
AnalogValue	190	PROCESS_RETURN_FLUID	Real
AnalogValue	191	PROCESS_DELTA_T_HMI	Real
AnalogValue	192	PROCESS_VARIABLE_HMI	Real
AnalogValue	193	EVAP_OUT_FLUID	Real
AnalogValue	194	EVAP_DELTA_T_HMI	Real
IntegerValue	195	HMI_ALARM_DISPLAY	Int

Table 9 – BACNet Parameters (continued)

Type	Object Instance	Variable Name	Data Type
IntegerValue	196	SUPPLY_WATER_BYPASS_REMIANING	Int
AnalogValue	197	SUPPLY_WATER_HIGH_WARNING_HMI	Real
IntegerValue	198	SUPPLY_WATER_HIGH_HIGH_FAULT_TIME	Int
AnalogValue	199	SUPPLY_WATER_LOW_WARNING_HMI	Real
IntegerValue	200	RETURN_WATER_HIGH_HIGH_FAULT_TIME	Int
AnalogValue	201	DISCHARGE_PERCENT	Real
AnalogValue	202	HGBP_PERCENT	Real
AnalogValue	203	HGBP_SETPOINT_HMI	Real
AnalogValue	204	EXV_PERCENT	Real
IntegerValue	205	NQV_DRV_SPEED_FEEDBACK_INT	Int
IntegerValue	206	NQV_DRV_PID_RPM	Int
IntegerValue	207	NQV_DRV_DEMAND_PERCENT	Int
IntegerValue	208	NQV_DRV_BUS_VOLTAGE	Int
IntegerValue	209	NQV_DRV_AC_INPUT_VOLTAGE	Int
IntegerValue	210	NQV_DRV_AC_INPUT_CURRENT	Int
IntegerValue	211	NQV_DRV_AC_INPUT_POWER	Int
IntegerValue	212	NQV_DRV_COMP_PHASE_CURRENT	Int
IntegerValue	213	NQV_STATOR_HEATING_WATTAGE	Int
AnalogValue	214	NQV_CSD100_SOFTWARE_VERSION	Real
IntegerValue	215	NQV_SPEED_REF_AFTER_ENVELOPE_CONTROL	Int
IntegerValue	216	NQV_SOFTWARE_SYSTEM_STATE	Int
PositiveIntegerValue	217	NQV_MODBUS_READ_COUNTER	UDInt
IntegerValue	218	NQV_FIELD_BUS_COMMS_MONITOR	Int
IntegerValue	219	NQV_TRIP_LOCKOUT_NUMBER	Int
IntegerValue	220	NQV_SYSTEM_CONTROL_WORD	Int
IntegerValue	221	NQV_EV2_03_MAX_FREQUENCY	Int
IntegerValue	222	NQV_EV2_04_MIN_FREQUENCY	Int
IntegerValue	223	NQV_EV2_05_STATUS	Int
IntegerValue	224	NQV_EV2_48_COMP_PHASE_CURRENT_FOLDBACK_STATUS	Int
IntegerValue	225	NQV_EV2_49_PWR_MOD_TEMP_FOLDBACK_STATUS	Int
IntegerValue	226	NQV_EV2_50_AC_INPUT_CURRENT_FOLDBACK_STATUS	Int
IntegerValue	227	NQV_EV2_59_POWERUP_STATUS	Int
AnalogValue	228	NQV_EV2_POWER_MODULE_TEMP	Real
AnalogValue	229	NQV_EV2_DLT	Real
IntegerValue	230	NQV_EV2_78_1ST_FAULT_OCCURRED	Int
IntegerValue	231	NQV_EV2_79_1ST_FAULT_OCCURRED	Int
IntegerValue	232	COMP1_ANTI_CYCLE_TIME	Int
IntegerValue	233	COMP2_ANTI_CYCLE_TIME	Int
AnalogValue	234	PUMP_PRESSURE_HMI	Real
AnalogValue	235	PROCESS_PUMP_PID_PERCENT	Real
AnalogValue	236	MOD_VALVE_CTRL_TEMP_HMI	Real
AnalogValue	237	MOD_VALVE_PERCENT	Real
AnalogValue	238	STAGE1_CUT_IN_TEMP_HMI	Real
AnalogValue	239	STAGE1_CUT_OUT_TEMP_HMI	Real
AnalogValue	240	STAGE2_CUT_IN_TEMP_HMI	Real
AnalogValue	241	STAGE2_CUT_OUT_TEMP_HMI	Real
IntegerValue	242	STAGED_COMPRESSORS_RUNNING	Int
IntegerValue	243	STAGED_COMPRESSORS_REQUESTED	Int
IntegerValue	244	STAGE_MINUTES_UNTIL_NEXT_STAGE	Int
IntegerValue	245	RETRANSMIT_PERCENT	Int
PositiveIntegerValue	246	CHILLER_STATUS	UInt
AnalogValue	247	EVAP_IN_FLUID_HMI	Real

Start-Up

The unit is factory set to standard operating specifications. Use a qualified refrigeration technician to perform the start-up procedure in sequence. The following serves as a checklist for the initial start-up and for subsequent start-ups if the chiller is out of service for a prolonged time.



WARNING: This equipment contains hazardous voltages that can cause severe injury or death.



WARNING: This equipment contains refrigerant under pressure. Accidental release of refrigerant under pressure can cause personal injury and or property damage.



WARNING: This equipment may contain fan blades or other sharp edges. Make sure all fan guards and other protective shields are securely in place.



WARNING: The exposed surfaces of motors, refrigerant piping, and other fluid circuit components can be very hot and can cause burns if touched with unprotected hands.



CAUTION: Disconnect and lock out incoming power before installing, servicing, or maintaining the equipment. Connecting power to the main terminal block energizes the entire electric circuitry of the unit. Electric power at the main disconnect should be shut off before opening access panels for repair or maintenance.



CAUTION: Wear eye protection when installing, maintaining, or repairing the equipment to protect against any sparks, debris, or fluid leaks.



CAUTION: Wear protective gloves when installing, maintaining, or repairing the equipment to protect against any sparks, debris, or fluid leaks.



CAUTION: The unit requires the main power to remain connected during off-hours to energize the compressor's crankcase heater. Disconnect main power only when servicing the chiller. The crankcase heater should remain on when the compressor is off to ensure liquid refrigerant does not accumulate in the compressor crankcase. Connect main power at least 24 hours prior to initial start-up.



CAUTION: Wire the unit ground in compliance with local and national codes.

Step 1 - Connect Main Power

Before connecting main power, ensuring it matches the voltage shown on the nameplate of the unit. Check the phasing prior to applying power. The proper sequence is "ABC." If the phasing is incorrect, open the main power disconnect and switch two line leads on the main power terminal blocks (or the unit mounted disconnect). All electrical components are in-phase at the factory. Do not interchange any load leads that are from the unit contactors or the motor terminals. After making proper power connection and grounding, turn the main power on.

Step 2 - Fill Coolant Circuit

Verify all process chilled-water piping connections are secure. Open the chiller cabinet and fill the coolant reservoir with the proper water or water/glycol solution following the guidelines shown below. When using a glycol solution only use glycol with a corrosion inhibitor.

System Fill Water Chemistry Requirements

The properties of water make it ideal for heat transfer applications. It is safe, non-flammable, non-poisonous, easy to handle, widely available, and inexpensive in most industrialized areas.

When using water as a heat transfer fluid it is important to keep it within certain chemistry limits to avoid unwanted side effects. Water is a "universal solvent" because it can dissolve many solid substances and absorb gases. As a result, water can cause the corrosion of metals used in a cooling system. When water is in an open system (exposed to air), the water evaporates but the dissolved minerals remain iff the concentration of dissolved minerals exceeds the solubility of the mineral and scale forms. The life giving properties of water can also encourage biological growth that can foul heat transfer surfaces.

To avoid the unwanted side effects associated with water cooling, proper chemical treatment and preventive maintenance is required for continuous plant productivity.

Unwanted Side Effects of Improper Water Quality

- Corrosion
- Scale
- Fouling
- Biological Contamination

Cooling Water Chemistry Properties

- Electrical Conductivity
- pH
- Alkalinity
- Total Hardness
- Dissolved gases

Chillers have two main heat exchangers: one that absorbs the heat from the process (evaporator) and one that removes the heat from the chiller (condenser). All our chillers use stainless steel brazed plate evaporators. Our air-cooled chillers use air to remove heat from the chiller; however, our water-cooled chillers use either a tube-in-tube or shell-in-tube condenser which have copper refrigerant tubes and a steel shell. These, as are all heat exchangers, are susceptible to fouling of the heat transfer surfaces due to scale or debris. Fouling of these surfaces reduces the heat-transfer surface area while increasing the fluid velocities and pressure drop through the heat exchanger. All of these effects reduce the heat transfer and affect the efficiency of the chiller.

The complex nature of water chemistry requires a specialist to evaluate and implement appropriate sensing, measurement and treatment needed for satisfactory performance and life that is safe and in compliance with the ever-changing regulations on water usage and treatment chemicals.

Table 10 – Fill Water Chemistry Requirements

Water Characteristic	Quality Limitation
Alkalinity (HCO ₃ ⁻)	70-300 ppm
Aluminum (Al)	Less than 0.2 ppm
Ammonium (NH ₃)	Less than 2 ppm
Chlorides (Cl ⁻)	Less than 300 ppm
Electrical Conductivity	10-500µS/cm
Free (aggressive) Carbon Dioxide (CO ₂)†	Less than 5 ppm
Free Chlorine(Cl ₂)	Less than 1 PPM
HCO ₃ ⁻ /SO ₄ ²⁻	Greater than 1.0
Hydrogen Sulfide (H ₂ S)	Less than 0.05 ppm
Iron (Fe)	Less than 0.2 ppm
Manganese (Mn)	Less than 0.1 ppm
Nitrate (NO ₃)	Less than 100 ppm
pH	7.5-9.0
Sulfate (SO ₄ ²⁻)	Less than 70 ppm
Total Hardness (dH)k	4.0-8.5

† Dissolved carbon dioxide calculation is from the pH and total alkalinity values shown below or measured on the site using a test kit. Dissolved Carbon Dioxide, PPM = TA x 2^[(6.3-pH)/0.3] where TA = Total Alkalinity, PPM as CaCO₃

Table 11 - Recommended Glycol Solutions

Chilled Water Temperature	Percent Glycol By Volume
50°F (10°C)	Not required
45°F (7.2°C)	5 %
40°F (4.4°C)	10 %
35°F (1.7°C)	15 %
30°F (-1.1°C)	20 %
25°F (-3.9°C)	25 %
20°F (-6.7°C)	30 %



CAUTION: When your application requires the use of glycol, use industrial grade glycol specifically designed for heat transfer systems and equipment. **Never use glycol designed for automotive applications.** Automotive glycols typically have additives engineered to benefit the materials and conditions found in an automotive engine; however, these additives can gel and foul heat exchange surfaces and result in loss of performance or even failure of the chiller. In addition, these additives can react with the materials of the pump shaft seals resulting in leaks or premature pump failures.



WARNING: Ethylene Glycol is flammable at higher temperatures in a vapor state. Carefully handle this material and keep away from open flames or other possible ignition sources.

Step 3 - Check Condenser

There are three possible types of condensers present in the chiller: Integral air-cooled, water-cooled, or remote air-cooled. Verify the chiller will have adequate condenser cooling for proper operation.

Integral Air-Cooled Condenser Check

Verify the installation is in accordance with the mechanical installation section of this manual. Make sure the chiller condenser is clear of obstructions and has at least 36 inches of open air on the air inlet and outlets for proper airflow.

Water-Cooled Condenser Check

Verify the condenser water line connections are secure. Make sure sufficient condenser water flow and pressure are available and all shut-off valves are open.

Remote Air-Cooled Condenser Check

Verify the refrigerant line connections are secure and that a proper evacuation of the chiller, field piping, and remote condenser has occurred. Verify the installation of the refrigeration piping is as described in the installation section of this manual. Check the remote condenser main power and control wiring to ensure all connections are secure.

Step 4 – Check Refrigerant Valves

During shipment or installation, it is possible valves where closed. Verify that all refrigerant valves are open.



CAUTION: Do not operate the unit with the compressor, oil line, or liquid line service valves closed. Failure to have these open may cause serious compressor damage.

Step 5 – Verify Freezestat Setting

Make sure the Freezestat setting is appropriate for the operating conditions of the chiller. The Freezestat setting is in a password-protected menu of the chiller controller. It should be set at 10°F below the minimum anticipated setpoint the chiller will be operating. Reference Table 11 to be sure the coolant solution is sufficient to provide freeze protection to at least 5°F below the Freezestat setting. All chillers ship from the factory with the Freezestat set at 38°F.



CAUTION: The manufacturer's warranty does not cover the evaporator from freezing. It is vital that the Freezestat is set properly.

Step 6 – Turn On Control Power

Turning main power on powers the control circuit. When the control power is first applied the system boots up and the HMI lights up. Due to extreme ambient temperatures that may occur during shipment, the High Refrigerant Pressure switch may have tripped. If this is the case, disconnect the main power, open the cabinet and reset the High Refrigerant Pressure by depressing the manual reset button located on the switch. Reconnect the main power, turn the control power on, and clear the alarm condition by pressing the Alarm Reset on the HMI.

Step 7 – Establish Coolant Flow

Standard units have an internal pump. To energize the pump, press the Start button. If the unit does not have an internal pump, energize the external pump to establish flow through the chiller.

Note: A positive flow through the evaporator is required to allow the compressor to operate.

Set water flow using a discharge throttling valve or flow control valve. The valve should be the same size as the To Process connection of the chiller. Standard chillers require approximately 2.4 gpm/ton of nominal capacity. A significant increase in flow beyond this in a standard chiller may result in excessive pressure loss and negatively impact chiller efficiency. In extreme cases, excessive flow may cause premature wear or damage of internal components.

Step 8 – Initial Unit Operation

Enter the desired leaving fluid temperature on the HMI. Unless otherwise specified, the chiller is factory set to deliver coolant at 50°F. Adjust to the desired operating temperature and press Start. Please note if there is insufficient load the compressor may cycle on and off causing swings in temperature.

Note: For chillers with the variable-speed compressor option operating under low load conditions with the compressor speed at its minimum, the hot gas system will maintain temperature 1° below setpoint.



WARNING: Never deactivate the High Refrigerant Pressure Switch or the Low Compressor Pressure Switch. Failure to heed this warning can cause serious compressor damage, severe personal injury, or death.

Note: For chillers with the variable-speed compressor option there is an initial startup routine that will run the compressor at a fixed speed for 2 minutes. After this routine the chiller will actively manage the system to maintain desired set point.

Operate the system for approximately 30 minutes then check the liquid line sight glass. The refrigerant flow past the sight glass should be clear. Bubbles in the refrigerant indicate either low refrigerant charge or excessive pressure drop in the liquid line. Indications of a shortage of refrigerant are low operating pressures or subcooling.

Normal subcooling ranges are from 10°F to 20°F. If it is not, check the superheat and adjust if required. Normal superheat is 10°F. If the operating pressures, sight glass, superheat, and subcooling readings indicate a refrigerant shortage, charge refrigerant as required. With the unit running, add refrigerant using industry best practices until operating conditions become normal.



CAUTION: A clear sight glass alone does not mean that the system is properly charged. Also, check system superheat, sub-cooling, and unit operating pressures. If both suction and discharge pressures are low but sub-cooling is normal, a problem other than refrigerant shortage exists. Do not add refrigerant, as this may result in overcharging the circuit.

After achieving proper flows and temperatures, press the Stop button. The unit is now ready for service.

Preventive Maintenance

After the chiller is in service, it is important to have a properly established preventive maintenance program. Follow the below maintenance schedule to reduced potential downtime, repair costs, and extends the useful life of the chiller.

Once a Week

1. (Air-Cooled Units Only) Check the surface of the air-cooled condenser coil for dirt and debris. To clean, rinse thoroughly with water and use a mild detergent to any remaining debris.
2. Verify the To Process temperature is reasonably close to the Set Point temperature. If the

temperature stays more than 5°F away from the set point, there may be a problem with the chiller. If this is the case, refer to the Troubleshooting Chart or contact the Customer Service Department for assistance.

3. Check the pump discharge pressure on the HMI. Investigate further if the pressure starts to stray away from the normal operating pressure.
4. Check the coolant level in the reservoir. Replenish if necessary making sure to maintain the appropriate freeze protection for minimum set point temperature the unit will run.
5. Check the coolant circulation pump for leaks in the seal area. Replace pump seal if necessary.
6. Check the refrigerant sight glass for bubbles or moisture indication. Sign of bubbles or moisture indicates a refrigeration problem. If that is the case, have the unit serviced as soon as possible.

Once a Month

Repeat items 1 through 6 listed above and continue with the following

7. With the main disconnect shut off and locked out, check the condition of electrical connections at all contactors, starters and controls. Check for loose or frayed wires.
8. Check the incoming voltage to make sure it is within 10% of the design voltage for the chiller.
9. Check the amp draws to each leg of the compressor (fans or blowers on air-cooled units) and pump(s) to confirm they are drawing the proper current.

Every Three Months

Repeat items 1 through 9 listed above and continue with the following.

10. Units are equipped with a Y-strainer between the return connection and the evaporator inlet. Remove and clean the strainer basket if necessary. This may be required more often if contaminants can easily get into the coolant.

11. Have a qualified refrigeration technician inspect the operation of the entire unit to ensure everything is operating properly. Have the condenser cleaned out if necessary.

12. (Units with a Variable-Speed compressor) Ensure the variable speed drive remains dust-free. Check the heat sink of the drive and make sure it and the ventilation fan of the drive are not gathering dust. Gently clean as necessary.

Preventive Maintenance Checklist

Maintenance Activity	Week Number												
	1	2	3	4	5	6	7	8	9	10	11	12	13
Date													
Clean Air Coils and Inlet Filters													
Temperature Control													
Pump Discharge Pressure													
Coolant Level													
Glycol Concentration													
Pump Seal													
Refrigerant Sight Glass													
Electrical Connections													
Incoming Voltage													
Compressor #1 L1 Amps													
Compressor #1 L2 Amps													
Compressor #1 L3 Amps													
Compressor #2 L1 Amps													
Compressor #2 L2 Amps													
Compressor #2 L3 Amps													
Pump L1 Amps													
Pump L2 Amps													
Pump L3 Amps													
Fan #1 L1 Amps													
Fan #1 L2 Amps													
Fan #1 L3 Amps													
Fan #2 L1 Amps													
Fan #2 L2 Amps													
Fan #2 L3 Amps													
Fan #3 L1 Amps													
Fan #3 L2 Amps													
Fan #3 L3 Amps													
Clean Y-Strainer													
Refrigerant Circuit Check													
Refrigerant Suction Pressure													
Refrigerant Discharge Pressure													
Refrigerant Superheat													

General Troubleshooting

Problem	Possible Cause	Remedy
Compressor will not start	Compressor overload	Check supply voltage, amperage of each leg, contactor and wiring, and overload set point
	Compressor contactor	Replace if faulty
	Compressor failure	Contact Customer Service for assistance
Pump will not start	Pump overload	Check supply voltage, amperage of each leg, contactor and wiring, and overload set point
	Pump contactor	Replace if faulty
	Pump failure	Replace if faulty
Low refrigerant pressure	Low refrigerant charge	Contact refrigeration service technician
	Refrigerant leak	Contact refrigeration service technician
	Low refrigeration pressure sensor	Check for proper range, replace if faulty
High refrigerant pressure (<i>Note: If a high-pressure alarm occurs, a manual reset of the high refrigerant pressure switch is required. To do this stop the unit, lock out the power, open the cabinet, located the high pressure switch, and manually press the reset, and correct the condition that caused the alarm before attempting a restart of the chiller</i>)	Dirty air filters (air-cooled units only)	Clean filters
	Air flow obstruction (air-cooled units only)	Make sure chiller is installed in accordance with recommendations in this manual
	High ambient air temperature (air-cooled units only)	Ambient temperature must be reduced below 110°F
	Condenser fan motor (air-cooled units only)	Replace if faulty
	Condenser fan cycling control (air-cooled units only)	Confirm proper operation, replace if faulty
	Plugged condenser (water-cooled units only)	Clean out tubes
	Insufficient condenser water flow (water-cooled units only)	Make sure chiller is installed in accordance with the recommendations of this manual
	High condenser water temperature (water-cooled units only)	Condenser water temperature must be reduced below 100°F
	Condenser water regulating valve	Check setting, replace if faulty
	Refrigerant circuit overcharged	Contact a refrigeration service technician
High refrigerant pressure sensor	Replace if faulty	
Freezestat	Low flow through evaporator	Adjust flow to proper level
	Freezestat control module	Check for proper setting (Protected Setting)
	Freezestat sensor	Replace if faulty
Low pump discharge pressure	Pump running backwards	Switch 2 legs of the incoming power
	Pump pressure gauge	Replace if faulty
	Pump failure	Replace if faulty
	Excessive flow	Reduce flow
High pump discharge pressure	Closed valves in process piping	Open valves
	Obstruction in piping or process	Remove obstruction
	Clogged Y-strainer	Clean strainer
	Pressure gauge	Replace if faulty
Erratic temperature control	Low coolant flow through evaporator	Adjust flow to proper level
	Intermittent overloading of chiller capacity	Check to make sure chiller is properly sized for process load
	Hot gas bypass valve	Contact refrigeration service technician
	Temperature sensor	Replace if faulty

General Troubleshooting (continued)

Problem	Possible Cause	Remedy
Insufficient cooling (temperature continues to rise above set point)	Process load too high	Check to make sure chiller is properly sized for process load
	Coolant flow through evaporator too high or low	Adjust flow to proper level
	Insufficient condenser cooling	See "High Refrigerant Pressure"
	Hot gas bypass valve stuck open	Contact refrigeration service technician
	Refrigeration circuit problem	Contact refrigeration service technician
	Temperature sensor	Replace if faulty

Drawings

Units ship from the factory with drawings inside the control panel. Refer to these drawings when troubleshooting, servicing, and installing the unit. For additional copies, contact our Customer Service Department and reference the serial number of your unit.

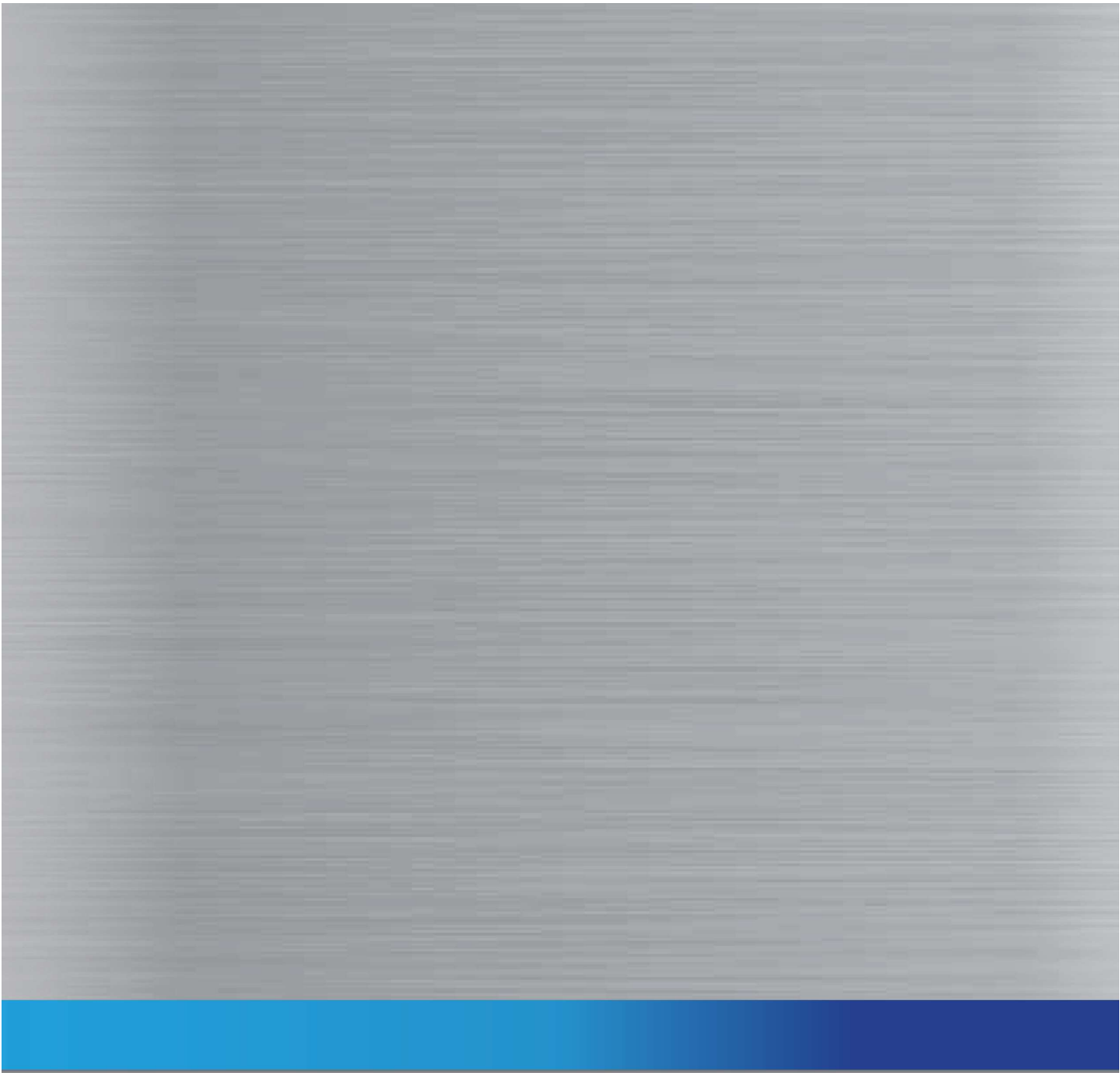

5680 W. Jarvis Ave. • Niles, IL 60714
847.966.2260
www.thermalcare.com

New Equipment Sales
847.966.2260
sales@thermalcare.com

Customer Service
847.966.2636
tcservice@thermalcare.com

Parts Department
847.966.8560
tcparts@thermalcare.com